

A

B

C

D

E

F

G

A

B

C

D

E

F

G

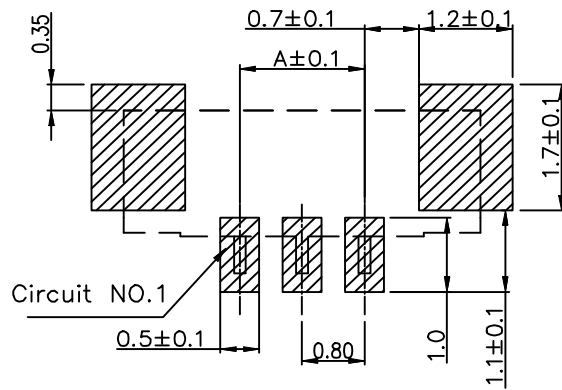
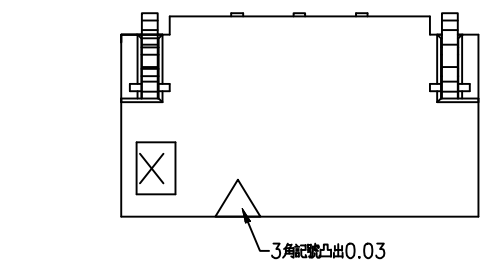

NOTE:
1.MATERIAL:
Housing: ThermalPlastic (UL94V-0)
Terminal: Phosper Bronze(t=0.15)
Fitting Nail:Brass(t=0.2)
2.PLATING
PLS SEE CRS PLATING CODE(P/N LEGEND)

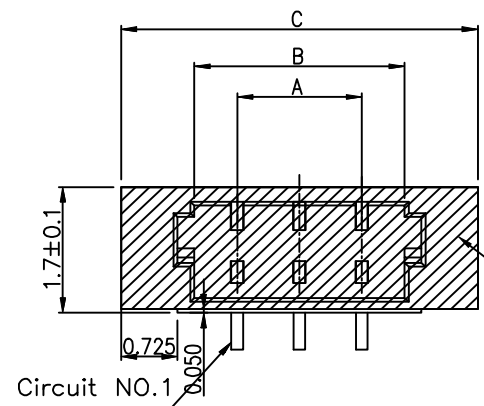

(15~20pin)mylar长*宽(12.0*1.7)
(11~15pin)mylar长*宽(9.0*1.7)
(6~10pin)mylar长*宽(6.0*1.7)
(2~5pin)mylar长*宽(3.0*1.7)

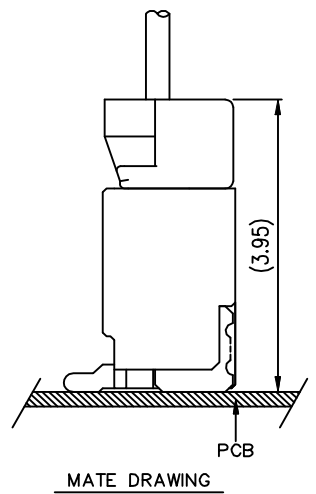
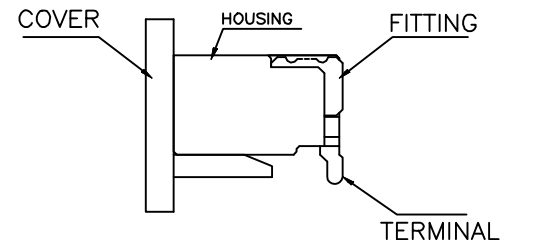
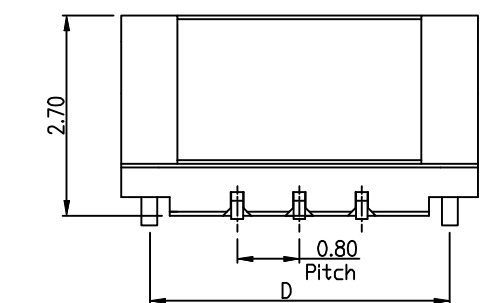
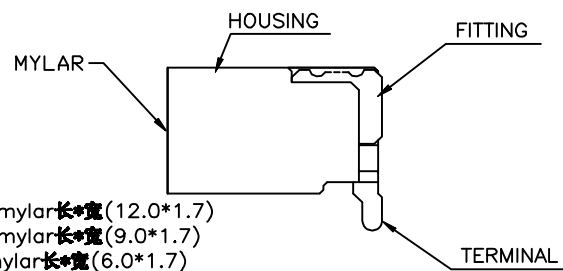

CKT	Dim A	Dim B	Dim C	Dim D
2	0.8	1.9	3.78	3.04
3	1.6	2.7	4.58	3.84
4	2.4	3.5	5.38	4.64
5	3.2	4.3	6.18	5.44
6	4	5.1	6.98	6.24
7	4.8	5.9	7.78	7.04
8	5.6	6.7	8.58	7.84
9	6.4	7.5	9.38	8.64
10	7.2	8.3	10.18	9.44
11	8	9.1	10.98	10.24
12	8.8	9.9	11.78	11.04
13	9.6	10.7	12.58	11.84
14	10.4	11.5	13.38	12.64
15	11.2	12.3	14.18	13.44
16	12	13.1	14.98	14.24
17	12.8	13.9	15.78	15.04
18	13.6	14.7	16.58	15.84
19	14.4	15.5	17.38	16.64
20	15.2	16.3	18.18	17.44

注：产品5Pin以下使用MYLAR，5Pin及以上Pin数产品使用盖子或MYLAR依料号编码决定。

				TOLERANCE UNLESS OTHERWISE		DRAWN	CK tan	XFCN兴飞连接器有限公司		SHEET	1/1	
				X.	±0.30	X°	±5°	CONNECTORS XFCN CONNECTORS CO., LTD.		DATE	2010. 4. 12	
				.X	±0.20	.X°	±2°	PRODUCT NAME		UNITS	mm	
				.XX	±0.08	.XX°	±1°	PART. NO.		SCALE	1:1	
A0	MODIFICATION		DRAW	DATE	.XXX	±0.03	.XXX°	±0.5°	M0800VS-XX-GN		DWG NO.	009

X-ON Electronics

Largest Supplier of Electrical and Electronic Components

Click to view similar products for [Headers & Wire Housings](#) category:

Click to view products by [XFCN](#) manufacturer:

Other Similar products are found below :

[95000-104TRLF](#) [10135584-644402LF](#) [DF62W-EP2022PCA](#) [95000-106TRLF](#) [DF62W-2022SCA](#) [DF62W-EP2022PC](#) [2203348](#) [DF62W-2022SC](#) [1084018](#) [1029039](#) [1084017](#) [802-10-012-10-002000](#) [1112640](#) [1112639](#) [891-007-9SS-BST1T](#) [000-34000](#) [0008550134](#) [0009482033](#) [0009507031](#) [57102-F02-18ULF](#) [57102-S06-03LF](#) [57202-S52-04LF](#) [PCN6-15S-2.5E](#) [0039019024](#) [58102-G61-06LF](#) [582553-1](#) [0009485154](#) [0009508121](#) [0022285053](#) [0050291907](#) [018731A](#) [LY20-4P-DT1-P1E-BR](#) [02.125.8002.8](#) [60101931](#) [60598-1 \(Cut Strip\)](#) [M1625-3R/100](#) [61062-3](#) [61082-181009](#) [CSU011177004](#) [636-1427](#) [638009-1](#) [641938-9](#) [641991-4](#) [644168-1](#) [644827-2](#) [647662-1](#) [65039-019ELF](#) [65692-001LF](#) [65781-018](#) [65781-047](#)