

环保物料

TEL: 0769-82001899

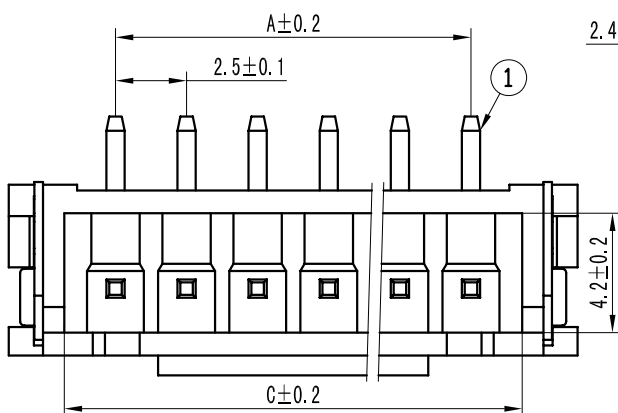
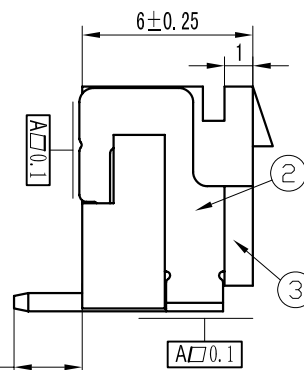
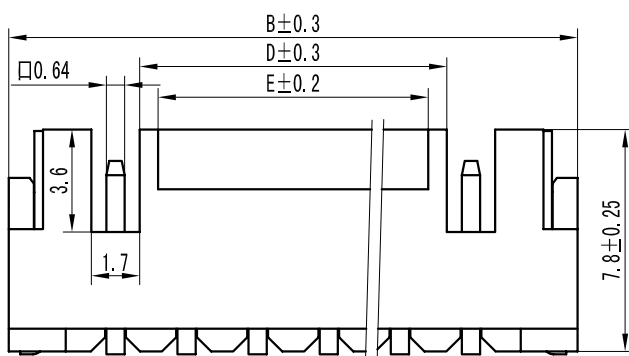
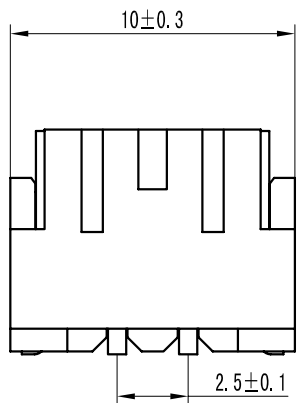

SPECIFICATIONS

Voltage rating: 250V AC, DC
 Current rating: 3A, AC, DC
 Withstanding Voltage: 1000V AC/minute
 Insulation resistance: 1000M min
 Temperature range: -25 °C ~ +85 °C
 Contact resistance: 10m max
 Housing Material: LCP UL94V-0
 Pin Material: Brass
 Contact Area Plating: Tin-Plated

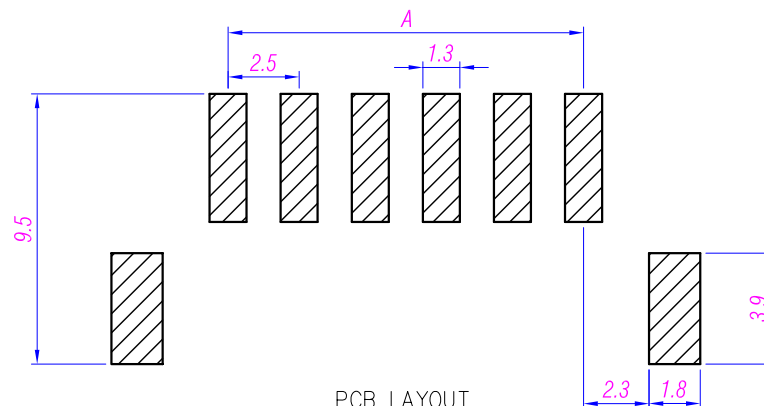
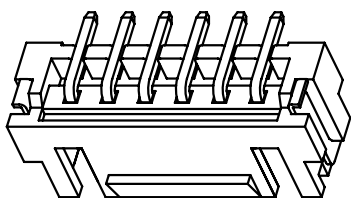

Type	Dimension mm					Type	Dimension mm				
	A	B	C	D	E		A	B	C	D	E
2	2.50	10.00	5.95			10	22.50	30.00	25.95	20.80	19.50
3	5.00	12.50	8.45	3.30	2.50	11	25.00	32.50	28.45	23.30	22.00
4	7.50	15.00	10.95	5.80	4.50	12	27.50	35.00	30.95	25.80	24.50
5	10.00	17.50	13.45	8.30	7.00	13	30.00	37.50	33.45	28.30	27.00
6	12.50	20.00	15.95	10.80	9.50	14	32.50	40.00	35.95	30.80	29.50
7	15.00	22.50	18.45	13.30	12.00	15	35.00	42.50	38.45	33.30	32.00
8	17.50	25.00	20.95	15.80	14.50	16	37.50	45.00	40.95	35.80	34.50
9	20.00	27.50	23.45	18.30	17.00	-	-	-	-	-	-

TOLERANCE UNLESS OTHERWISE				DRAWN	CK tan
X.	±0.30	X°	±5°	CHKD	
.X	±0.20	.X°	±2°	APPD	
.XX	±0.08	.XX°	±1°	VIEW	⊕
.XXX	±0.03	.XXX°	±0.5°		

XFCN 兴飞连接器有限公司		SHEET	1/1
CONNECTORS XFCN CONNECTORS CO., LTD.		DATE	2010. 4. 12
PRODUCT NAME	2.50mm Crimp Style Connectors	UNITS	mm
PART. NO.	M2501VSF-XX-LP	SCALE	1:1
		DWG NO.	009

AO
VER

MODIFICATION

DRAW

DATE

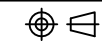

VIEW

X-ON Electronics

Largest Supplier of Electrical and Electronic Components

Click to view similar products for [Headers & Wire Housings](#) category:

Click to view products by [XFCN](#) manufacturer:

Other Similar products are found below :

[95000-104TRLF](#) [10135584-644402LF](#) [DF62W-EP2022PCA](#) [95000-106TRLF](#) [DF62W-2022SCA](#) [DF62W-EP2022PC](#) [2203348](#) [DF62W-2022SC](#) [1084018](#) [1029039](#) [1084017](#) [802-10-012-10-002000](#) [1112640](#) [1112639](#) [891-007-9SS-BST1T](#) [000-34000](#) [0008550134](#) [0009482033](#) [0009507031](#) [57102-F02-18ULF](#) [57102-S06-03LF](#) [57202-S52-04LF](#) [PCN6-15S-2.5E](#) [0039019024](#) [58102-G61-06LF](#) [582553-1](#) [0009485154](#) [0009508121](#) [0022285053](#) [0050291907](#) [018731A](#) [LY20-4P-DT1-P1E-BR](#) [02.125.8002.8](#) [60101931](#) [60598-1 \(Cut Strip\)](#) [M1625-3R/100](#) [61062-3](#) [61082-181009](#) [CSU011177004](#) [636-1427](#) [638009-1](#) [641938-9](#) [641991-4](#) [644168-1](#) [644827-2](#) [647662-1](#) [65039-019ELF](#) [65692-001LF](#) [65781-018](#) [65781-047](#)