

2~5PIN无卡点视图

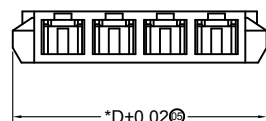

*D±0.02

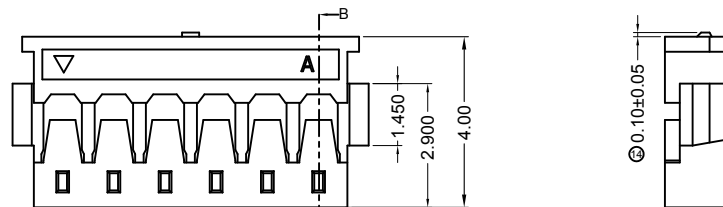

6PIN卡点视图

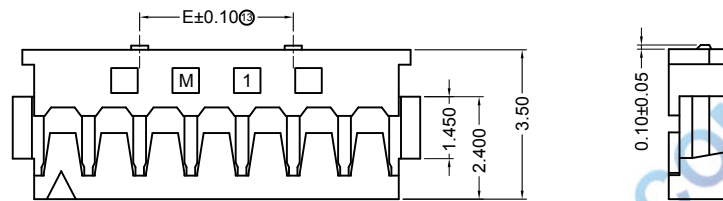

7PIN卡点视图

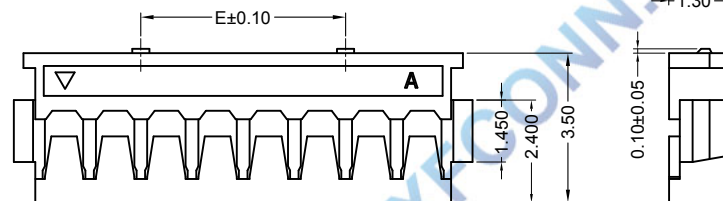

8~10PIN卡点视图

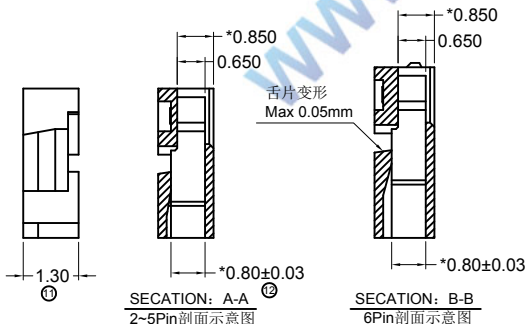
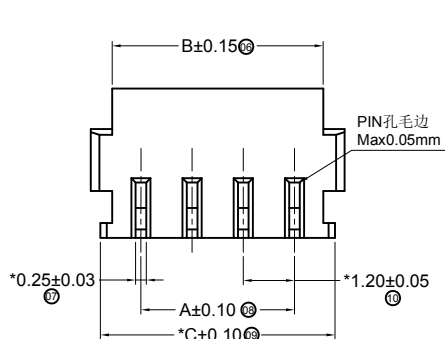

SECTION: A-A
2-5Pin剖面示意图

SECTION: B-B
6Pin剖面示意图

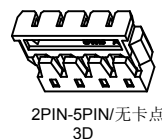

2PIN-5PIN/无卡点
3D

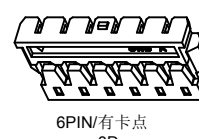

6PIN/有卡点
3D



7-10PIN/有卡点
3D

SPECIFICATIONS

1. Voltage rating: 50V AC, DC
2. Current rating: 2A, AC, DC
3. Withstanding Voltage: 500V AC/minute
4. Insulation resistance: 100MΩ min
5. Temperature range: -25 °C ~ +85 °C
6. Contact resistance: 20mΩ max

HOUSING

Housing Material: Nylon66 UL94V-0(2)
 Accepts: T1201 terminal
 Mates with: M1201 series header
 Poles: 02-10P
 Part No.: P1201-xx-BK

Pin位数

| Poles | Dimensions(mm) | | | | |
|-------|----------------|-------|-------|-------|------|
| | A | B | C | D | E |
| 2 | 1.20 | 2.60 | 3.10 | 3.60 | |
| 3 | 2.40 | 3.80 | 4.30 | 4.80 | |
| 4 | 3.60 | 5.00 | 5.50 | 6.00 | |
| 5 | 4.80 | 6.20 | 6.70 | 7.20 | |
| 6 | 6.00 | 7.40 | 7.90 | 8.40 | |
| 7 | 7.20 | 8.60 | 9.10 | 9.60 | 3.60 |
| 8 | 8.40 | 9.80 | 10.30 | 10.80 | 4.80 |
| 9 | 9.60 | 11.00 | 11.50 | 12.00 | 3.60 |
| 10 | 10.80 | 12.20 | 12.70 | 13.20 | 4.80 |

| | | | | | | | | | | | |
|-----------|--------------|------|------|----------------------------|-------|-------|--------|---|--------------|-------------------------------|------|
| | | | | TOLERANCE UNLESS OTHERWISE | | DRAWN | CK tan | XFCN兴飞连接器有限公司 CONNECTORS XFCN CONNECTORS CO., LTD. | | SHEET | 1/1 |
| | | | | X. | ±0.30 | X° | ±5° | | | CHKD | DATE |
| | | | | .X | ±0.20 | .X° | ±2° | APPD | PRODUCT NAME | 1.20mm Crimp Style Connectors | |
| | | | | .XX | ±0.08 | .XX° | ±1° | VIEW | PART. NO. | P1201-xx-BK | |
| | | | | .XXX | ±0.03 | .XXX° | ±0.5° | | | | |
| AO VER | MODIFICATION | DRAW | DATE | | | | | | | | |

X-ON Electronics

Largest Supplier of Electrical and Electronic Components

Click to view similar products for [Headers & Wire Housings](#) category:

Click to view products by [XFCN](#) manufacturer:

Other Similar products are found below :

[57102-F02-18ULF](#) [58102-G61-06LF](#) [0009485154](#) [009176003701906](#) [0050291907](#) [02.125.8002.8](#) [609-3404](#) [61062-3](#) [622-0430](#) [622-3653LF](#)
[63453-116](#) [636-1030](#) [636-1427](#) [636-3427](#) [636-4007](#) [641938-9](#) [644827-2](#) [65495-038](#) [65692-001LF](#) [65781-018](#) [65781-047](#) [65817-010LF](#)
[65817-015LF](#) [66207-023LF](#) [67016-026LF](#) [67095-007LF](#) [68631-112](#) [68645-018](#) [68648-049](#) [699319-000](#) [70.362.1628.0](#) [70-4210](#) [70-4226B](#)
[70-4853B](#) [707-5020](#) [707-5028](#) [71.350.2428.0](#) [71961-016LF](#) [733-134](#) [754199-000](#) [760-3052](#) [787-8014-00](#) [FCN-367T-T012/H](#) [80.063.4001.1](#)
[800-90-001-10-001000](#) [800-90-010-10-002000](#) [801-43-002-10-013000](#) [801-43-006-10-002000](#) [803-41-018-10-001000](#) [803-43-014-20-](#)
[001000](#)