

2~5PIN无卡点视图

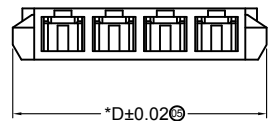

\*D±0.02

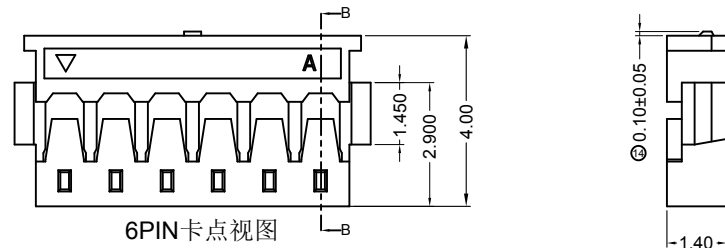

6PIN卡点视图

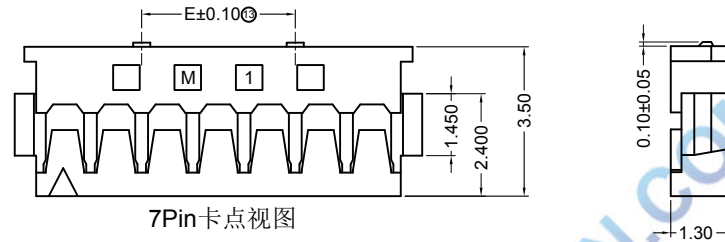

7PIN卡点视图

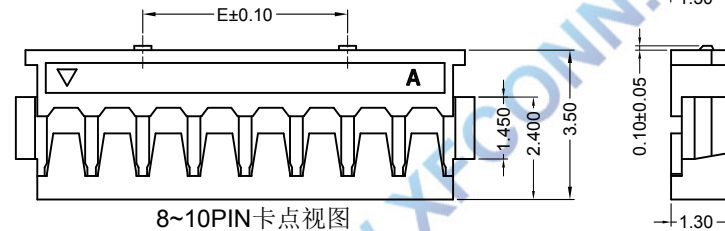

8~10PIN卡点视图

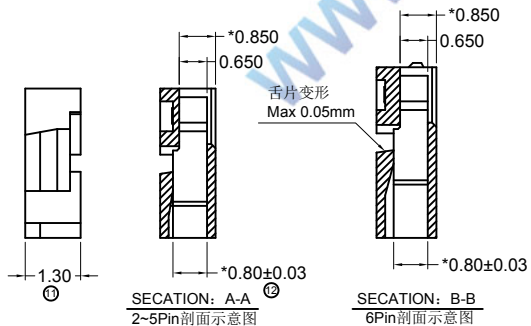
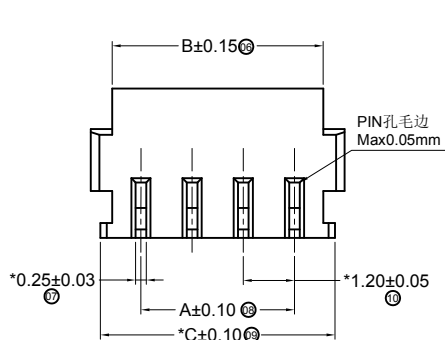

SECTION: A-A  
2-5Pin剖面示意图

SECTION: B-B  
6Pin剖面示意图

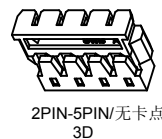

2PIN-5PIN/无卡点  
3D

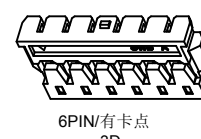

6PIN/有卡点  
3D



7-10PIN/有卡点  
3D

SPECIFICATIONS

1. Voltage rating: 50V AC, DC
2. Current rating: 2A, AC, DC
3. Withstanding Voltage: 500V AC/minute
4. Insulation resistance: 100M min
5. Temperature range: -25 ° C-+85 ° C
6. Contact resistance: 20m max

HOUSING

Housing Material: Nylon66 UL94V-0(2)  
 Accepts: T1201 terminal  
 Mates with: M1201 series header  
 Poles: 02-10P  
 Part No.: P1201-xx-BK

Pin位数

Poles	Dimensions(mm)				
	A	B	C	D	E
2	1.20	2.60	3.10	3.60	
3	2.40	3.80	4.30	4.80	
4	3.60	5.00	5.50	6.00	
5	4.80	6.20	6.70	7.20	
6	6.00	7.40	7.90	8.40	
7	7.20	8.60	9.10	9.60	3.60
8	8.40	9.80	10.30	10.80	4.80
9	9.60	11.00	11.50	12.00	3.60
10	10.80	12.20	12.70	13.20	4.80



				TOLERANCE UNLESS OTHERWISE		DRAWN	CK tan	XFCN兴飞连接器有限公司 CONNECTORS XFCN CONNECTORS CO., LTD.		SHEET	1/1
				X.	±0.30	X°	±5°			CHKD	DATE
				.X	±0.20	.X°	±2°	APPD	PRODUCT NAME	1.20mm Crimp Style Connectors	
				.XX	±0.08	.XX°	±1°	VIEW	PART. NO.	P1201-xx-BK	
				.XXX	±0.03	.XXX°	±0.5°				
AO VER	MODIFICATION	DRAW	DATE								

## X-ON Electronics

Largest Supplier of Electrical and Electronic Components

*Click to view similar products for [Headers & Wire Housings](#) category:*

*Click to view products by [XFCN](#) manufacturer:*

Other Similar products are found below :

[57102-F02-18ULF](#) [58102-G61-06LF](#) [0009485154](#) [009176003701906](#) [0050291907](#) [02.125.8002.8](#) [609-3404](#) [61062-3](#) [622-0430](#) [622-3653LF](#)  
[63453-116](#) [636-1030](#) [636-1427](#) [636-3427](#) [636-4007](#) [641938-9](#) [644827-2](#) [65495-038](#) [65692-001LF](#) [65781-018](#) [65781-047](#) [65817-010LF](#)  
[65817-015LF](#) [66207-023LF](#) [67016-026LF](#) [67095-007LF](#) [68631-112](#) [68645-018](#) [68648-049](#) [699319-000](#) [70.362.1628.0](#) [70-4210](#) [70-4226B](#)  
[70-4853B](#) [707-5020](#) [707-5028](#) [71.350.2428.0](#) [71961-016LF](#) [733-134](#) [754199-000](#) [760-3052](#) [787-8014-00](#) [FCN-367T-T012/H](#) [80.063.4001.1](#)  
[800-90-001-10-001000](#) [800-90-010-10-002000](#) [801-43-002-10-013000](#) [801-43-006-10-002000](#) [803-41-018-10-001000](#) [803-43-014-20-](#)  
[001000](#)