

RoHS

REV.	ECN NO.	DESCRIPTION	DESIGN	APPROVAL	DATE
A1	NEW	更换图框			2023.09.05

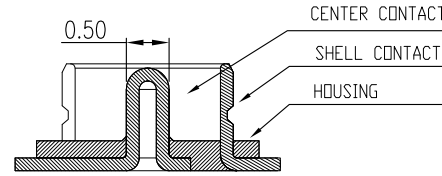

Electrical  
 Rated Voltage:60V AC  
 Current:0.5A  
 Contact Resistance:20m . Max  
 Dielectric Withstanding Voltage:500V  
 Insulation Resistance:1000m . Min  
 VSWR:  
 DC to 3GHz:1.3 max  
 3GHz to 6GHz:1.4 max  
 Physical  
 Housing :LCP,UL94V-0  
 Contact:Copper Alloy  
 Metal:Copper Alloy  
 Plating:Au or Ag  
 Operating Temperature:-20/ +85  
 Durability:30cycles  
 Solder joint peel strength:10N.min  
 Reference Information  
 Packaging:Reel  
 Quantity:5000Pcs/Reel

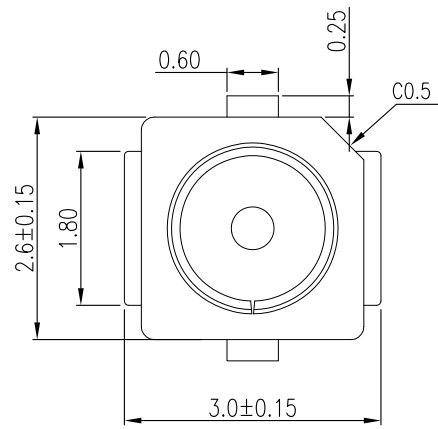
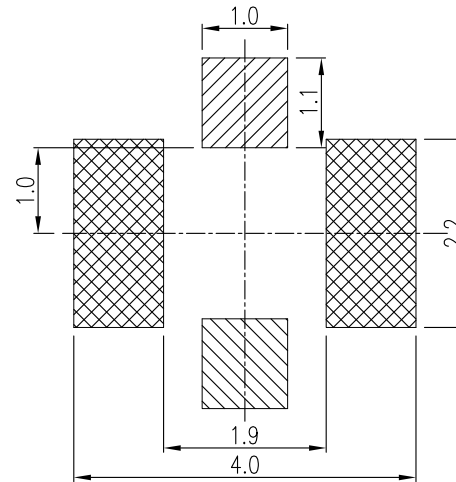
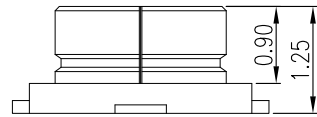
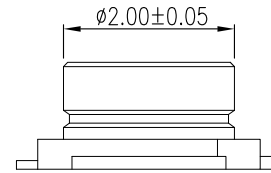

RECOMMENDED PCB LAYOUT

<TOLERANCE:±0.05>

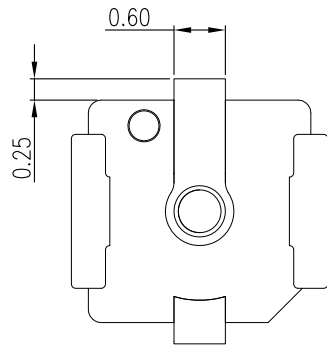
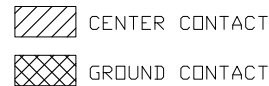

X.±0.50	X.°±
.X±0.25	.X°±
.XX± 0.15	.XX°±
.XXX± 0.10	.XXX°±
UNITS:	mm

THESE DRAWINGS AND SPECIFICATIONS ARE THE PROPERTY OF XFCN AND SHALL NOT BE REPRODUCED, COPIED OR CUED IN ANY MANNER WITHOUT THE PRIOR WRITTEN CONSENT OF XFCN

PART NO.:	RF2200001R	<b>XFCN</b> 兴飞连接器			
TITLE:	超小型同轴连接器	0769-82001899			
		www.xfconn.com			
APPD:		DWG NO: /			
CHKD:			SCALE	SHEET	REV.
DRAW: Tong.Deng	2023.09.11		NONE	1/1	A1

## X-ON Electronics

Largest Supplier of Electrical and Electronic Components

*Click to view similar products for [RF Connectors](#) / [Coaxial Connectors](#) category:*

*Click to view products by [XFCN](#) manufacturer:*

Other Similar products are found below :

[8915-1511-000](#) [89674-0827](#) [6002-7051-003](#) [6059674-1](#) [630059-000](#) [M39030/3-01N](#) [6501-1071-002](#) [6769](#) [7002-1572-002](#) [7003-1542-011](#)  
[7003-1572-002](#) [7004-1512-000](#) [7009-1511-004](#) [7101-1541-010](#) [7105-1521-002](#) [7145-1521-002](#) [7203-1571-003](#) [7209-1511-011](#) [7210-1511-](#)  
[040](#) [7242-1511-000](#) [73216-2241](#) [73404-2300](#) [7405-1521-005](#) [7405-1521-802](#) [8527](#) [8547](#) [FS11V](#) [8808-1511-001](#) [9074-9513-000](#) [PL11C-](#)  
[026](#) [PL40-5](#) [PL71-9](#) [PL74C-221](#) [9408-1113-000](#) [980-8666-005](#) [1200690078](#) [1-201144-1](#) [120919](#) [R107003010W](#) [R112186000](#)  
[R113053000W](#) [R113082097](#) [R113236000](#) [R113240000](#) [R113240097](#) [R114083000](#) [R114670000W](#) [R123415000W](#) [R124072220W](#)  
[R124076320](#)