

FH4606B
增强型N+P沟道MOS管
特点

- 超高密度电池设计
- 可靠耐用
- 封装形式：SO-8
- 工作温度范围：-55~150℃

产品应用

- 用在笔记本电脑的电源管理系统
- 用在便携式设备和电池的供电系

■ 特征
N沟道

30V/7A

 $R_{DS(ON)}=18m\Omega$ (typ.) @VGS=10V

 $R_{DS(ON)}=25m\Omega$ (typ.) @VGS=4.5V

P沟道

-30V/-5.5A

 $R_{DS(ON)}=40m\Omega$ (typ.) @VGS= -10V

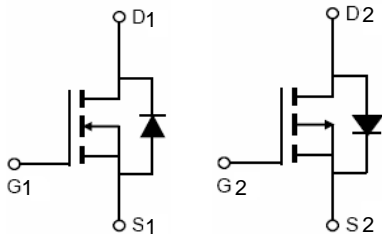
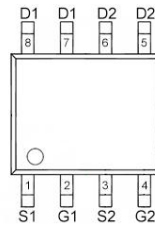
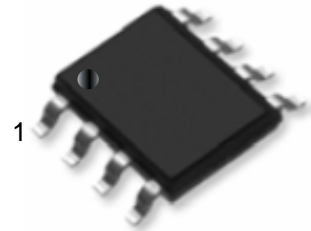
 $R_{DS(ON)}=62m\Omega$ (typ.) @VGS= -4.5V

N-channel
P-channel
Schematic diagram

Marking and pin assignment

SO-8 top view
绝对最大额定值 (TA=25℃ 除非另有说明)

符号	参数	N 沟道	P 沟道	单位
V _{DSS}	漏源电压	30	-30	V
I _D	漏极连续电流	7	-5.5	A
I _{DM}	漏极脉冲电流	28	-22	
T _J	工作结最高温度	150		℃
T _{STG}	储存温度范围	-55—150		
P _D	功耗	T _A =25℃	2	W
		T _A =100℃	0.8	
R _{θJA}	Thermal Resistance -Junction to Ambient	62.5		℃/W

电气特性 (TA=25°C, 除非另有说明)

符号	参数	测试条件	最小值	典型值	最大值	单位	
静态							
BV _{DSS}	漏极击穿电压	V _{GS} =0V, I _{DS} =250uF	N-CH	30		V	
		V _{GS} =0V, I _{DS} =-250uF	P-CH	-30			
I _{DSS}	零栅极电压漏极电流	V _{DS} =24V, V _{GS} =0V	N-CH		1	uA	
		V _{DS} =-24V, V _{GS} =0V	P-CH		-1		
V _{GS(TH)}	栅极阈值电压	V _{DS} =V _{GS} , I _{DS} =250uA	N-CH	1.0	1.6	2.5	V
		V _{DS} =V _{GS} , I _{DS} =-250uA	P-CH	-1.0	-1.8	-2.5	
I _{GSS}	栅极漏电流	V _{GS} =±20V, V _{DS} =0V	N-CH			±100	nA
			P-CH			±100	
R _{DS(ON)}	漏源导通电阻	V _{GS} =4.5V, I _{DS} =5A	N-CH		25	30	mΩ
		V _{GS} =-4.5V, I _{DS} =-2A	P-CH		62	80	
		V _{GS} =10V, I _{DS} =7A	N-CH		18	22	
		V _{GS} =-10V, I _{DS} =-3A	P-CH		40	55	

二极管							
V _{SD}	二极管正向电压	I _{SD} =2A, V _{GS} =0V	N-CH		0.8	1.2	V
		I _{SD} =-1A, V _{GS} =0V	P-CH		-1.5	-1.0	
动态							
R _G	栅极电阻	V _{GS} =0V, V _{DS} =0V, F=1MHZ	N-CH		2		Ω
			P-CH		11		
C _{ISS}	输入电容	N-Channel V _{GS} =0V V _{DS} =25V F=1MHZ P-Channel V _{GS} =0V V _{DS} =-25V F=1MHZ	N-CH		345		pF
C _{OSS}	输出电容		P-CH		560		
			N-CH		55		
C _{rss}	反向传输电容		P-CH		55		
			N-CH		35		
t _{d(on)}	打开延时时间		N-Channel V _{DD} =15V, R _L =15Ω	N-CH		11	
		P-CH			12	24	

T _r	打开上升时间	I _{DS} =1A, V _{GEN} =10V R _G =6 Ω	N-CH	17	28
			P-CH	15	29
T _{d(off)}	关掉延时时间	P-Channel V _{DD} =-15V, R _L =-15 Ω	N-CH	36	62
			P-CH	35	60
T _f	关掉下降时间	I _{DS} =-1A, V _{GEN} =-10V R _G =6 Ω	N-CH	20	36
			P-CH	15	30
栅极电荷					
Q _g	栅极总电荷	N-Channel V _{DS} =15V, V _{GS} =10V, I _{DS} =7A	N-CH	4.1	nC
			P-CH	9.2	
Q _{gs}	栅极源极电荷	P-Channel V _{DS} =-15V, V _{GS} =-10V, I _{DS} =-5.5A	N-CH	1	
			P-CH	1.6	
Q _{gd}	栅极漏极电荷		N-CH	2.1	
			P-CH	2.2	

典型特征

N 沟道

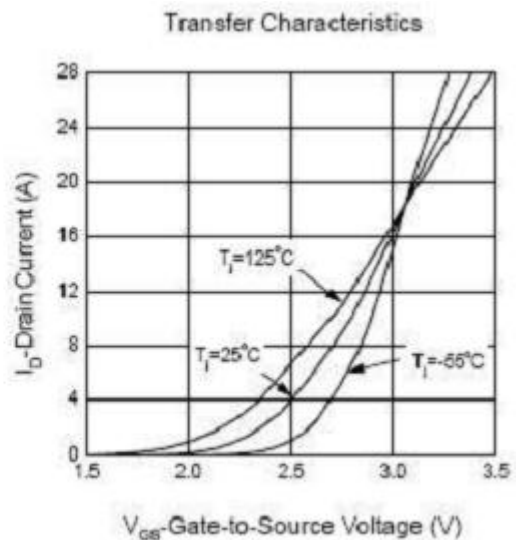
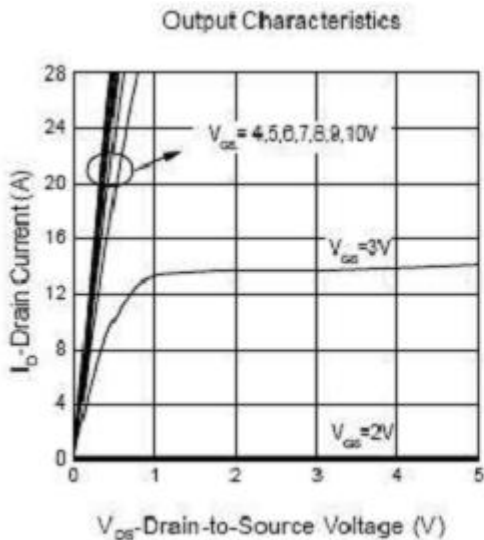

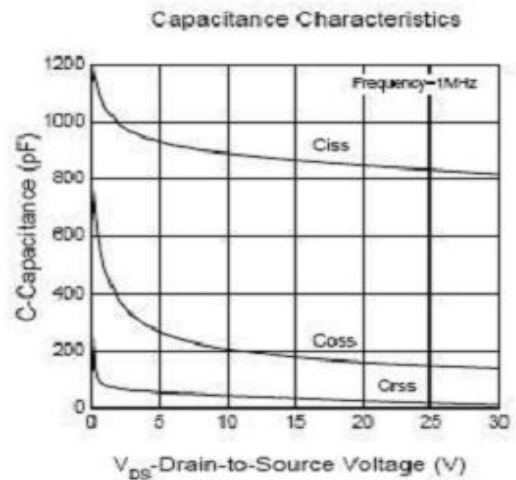
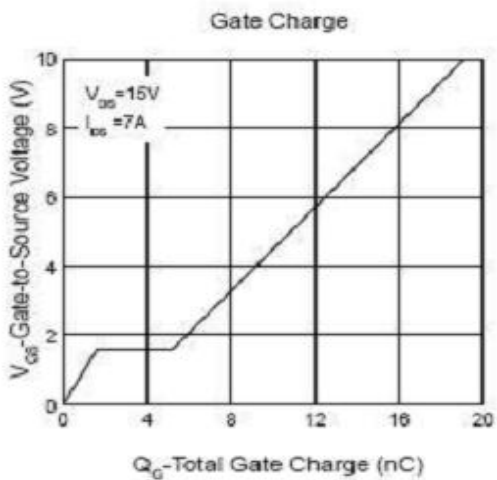
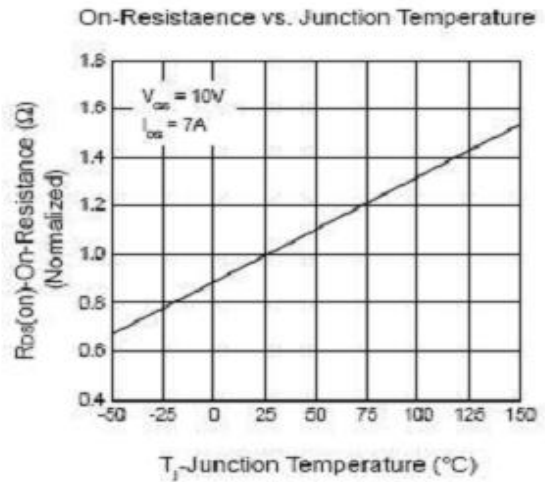
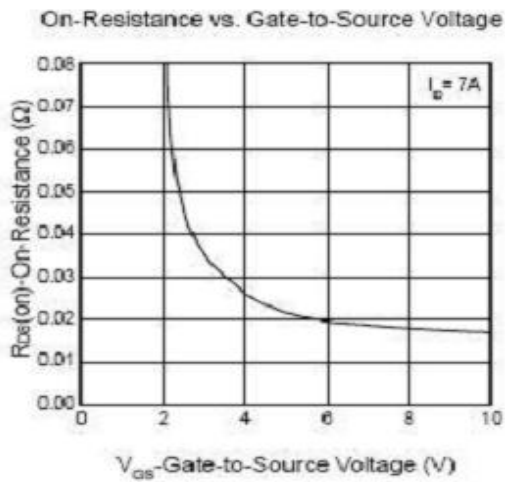
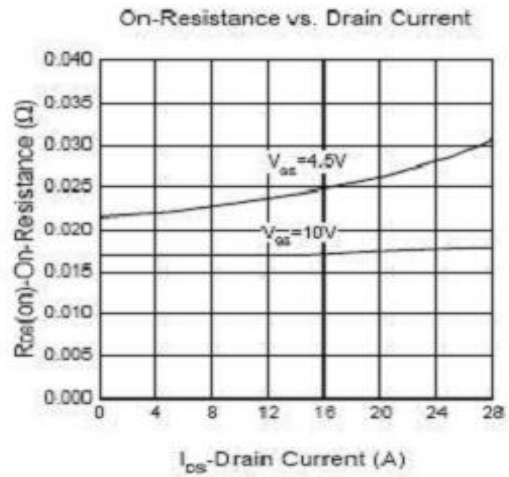
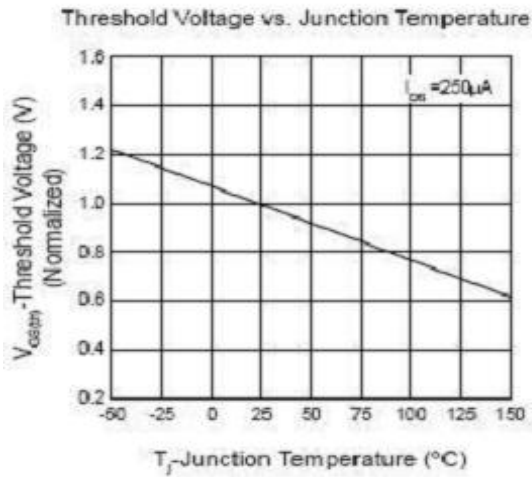

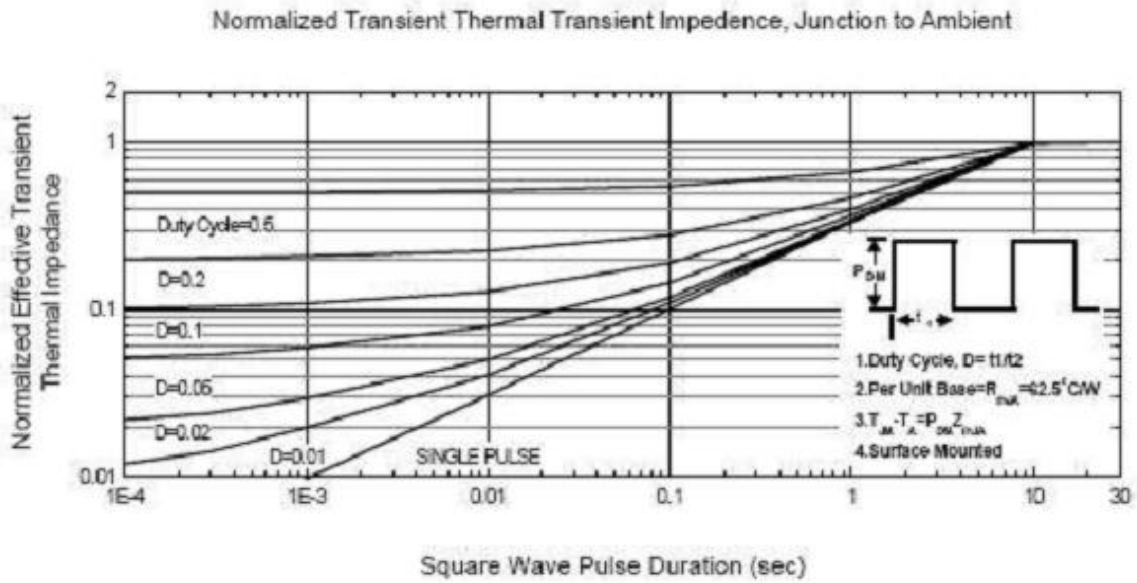
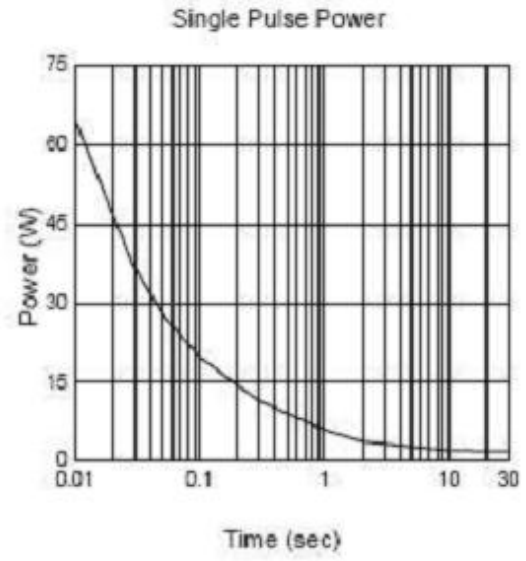
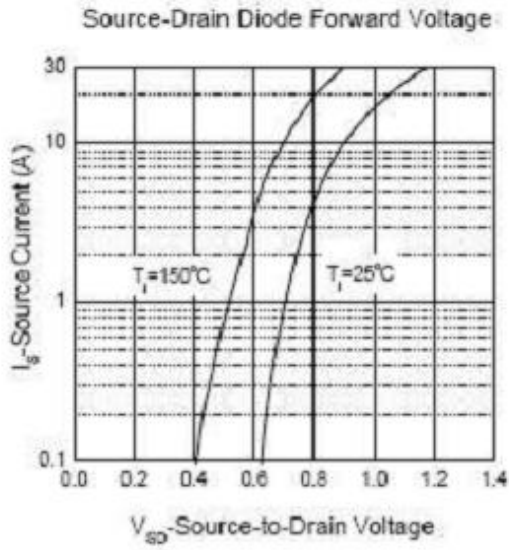

典型特性

P 沟道

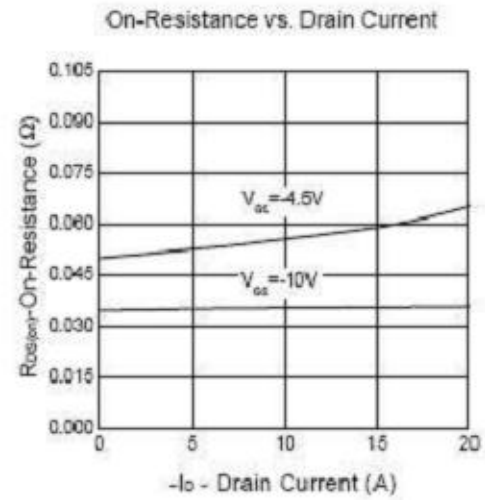
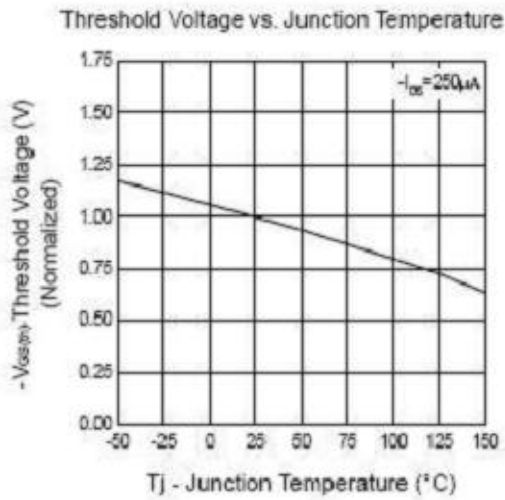
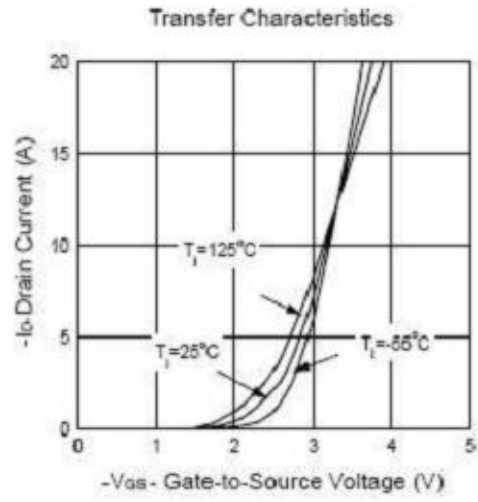
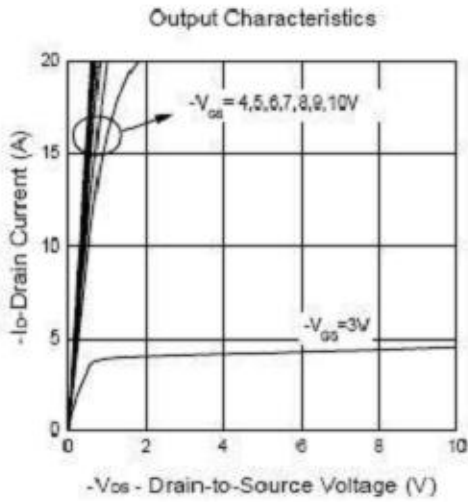

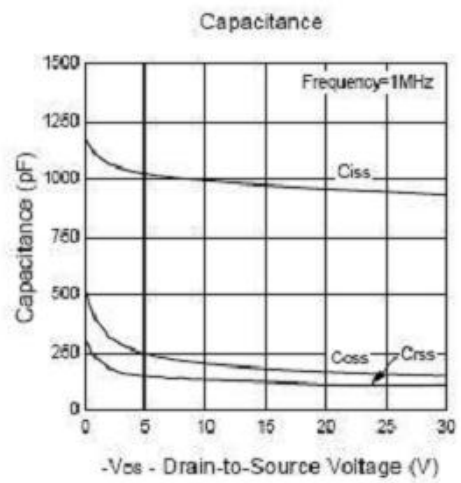
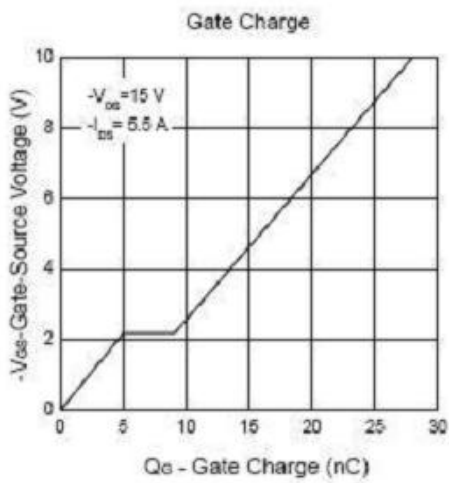
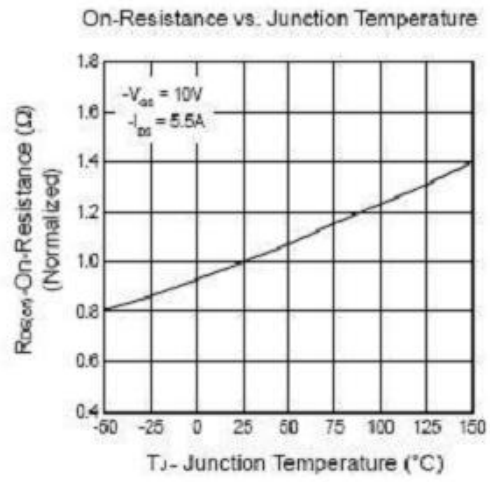
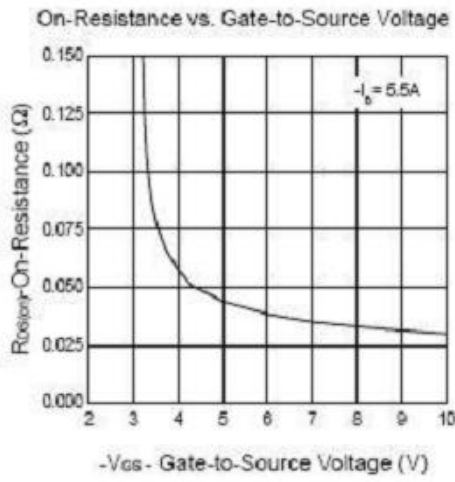

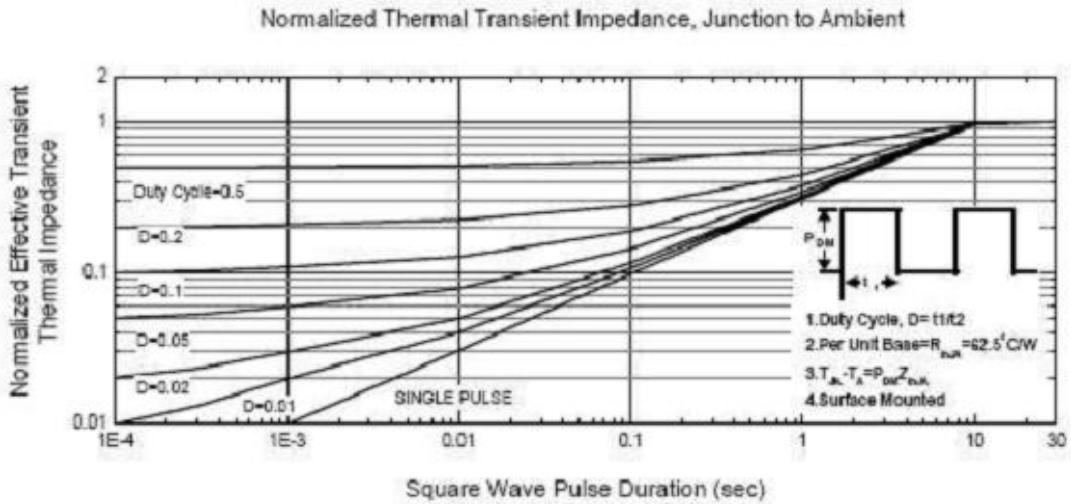
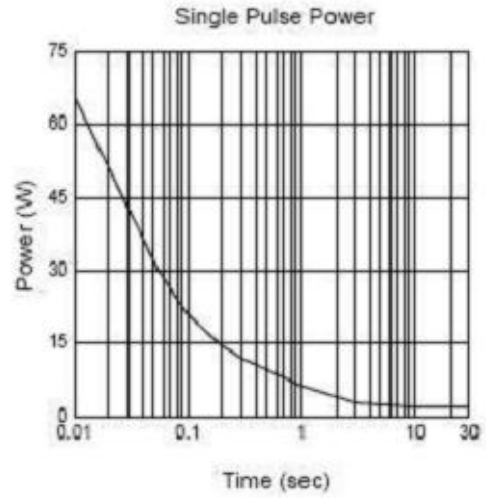
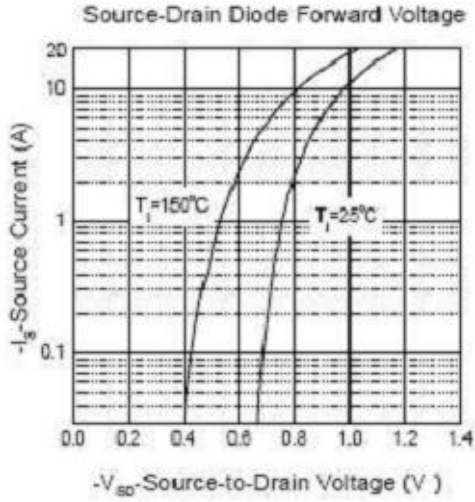

Package Information : SO-8

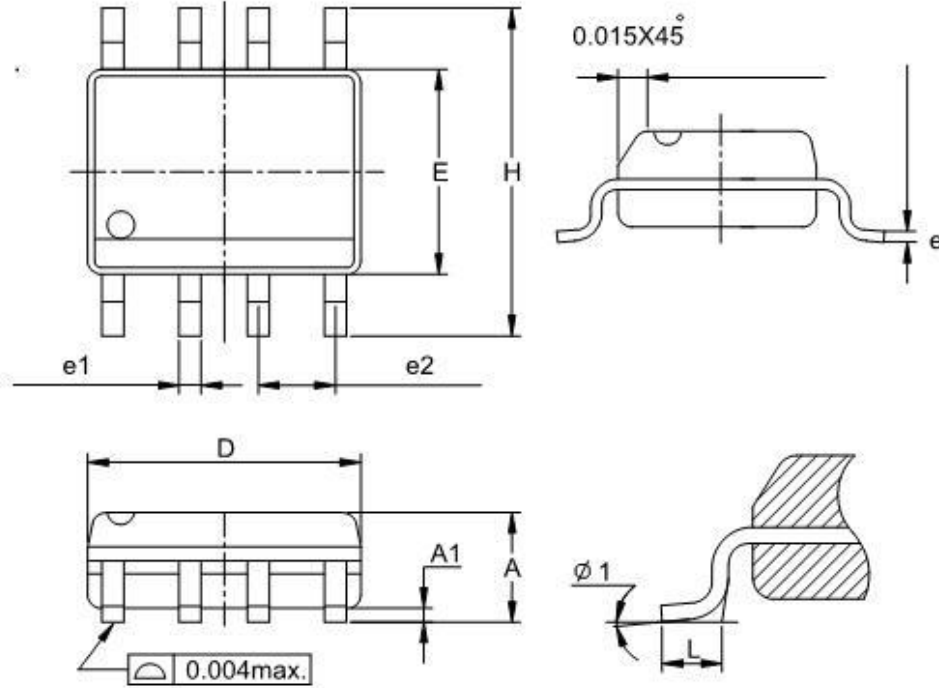

DIM	毫米		英寸	
	最小值	最大值	最小值	最大值
A	1.35	1.75	0.053	0.069
A1	0.10	0.25	0.004	0.010
D	4.80	5.00	0.189	0.197
E	3.80	4.00	0.150	0.157
H	5.80	6.20	0.228	0.244
L	0.40	1.27	0.016	0.050
E1	0.33	0.51	0.013	0.020
E2	1.27BSC		0.5BSC	
φ 1	8 °		8 °	

X-ON Electronics

Largest Supplier of Electrical and Electronic Components

Click to view similar products for [MOSFET](#) category:

Click to view products by [Xinfeihong](#) manufacturer:

Other Similar products are found below :

[614233C](#) [648584F](#) [MCH3443-TL-E](#) [MCH6422-TL-E](#) [NTNS3A92PZT5G](#) [IRFD120](#) [IRFF430](#) [JANTX2N5237](#) [2N7000](#) [AOD464](#)
[2SK2267\(Q\)](#) [2SK2545\(Q,T\)](#) [405094E](#) [423220D](#) [MIC4420CM-TR](#) [VN1206L](#) [614234A](#) [715780A](#) [SSM6J414TU,LF\(T](#) [751625C](#)
[IPS70R2K0CEAKMA1](#) [BSF024N03LT3 G](#) [PSMN4R2-30MLD](#) [TK31J60W5,S1VQ\(O](#) [2SK2614\(TE16L1,Q\)](#) [DMN1017UCP3-7](#)
[EFC2J004NUZTDG](#) [FCAB21350L1](#) [P85W28HP2F-7071](#) [DMN1053UCP4-7](#) [NTE2384](#) [NTE2969](#) [NTE6400A](#) [DMC2700UDMQ-7](#)
[DMN2080UCB4-7](#) [DMN61D9UWQ-13](#) [US6M2GTR](#) [DMN31D5UDJ-7](#) [SSM6P54TU,LF](#) [DMP22D4UFO-7B](#) [IPS60R3K4CEAKMA1](#)
[DMN1006UCA6-7](#) [DMN16M9UCA6-7](#) [STF5N65M6](#) [IRF40H233XTMA1](#) [IPSA70R950CEAKMA1](#) [IPSA70R2K0CEAKMA1](#) [STU5N65M6](#)
[C3M0021120D](#) [DMN6022SSD-13](#)