

# FH8818K

## N- Channel Enhancement Mode Power MOSFET

### Description

The FH8818K uses advanced trench technology to provide excellent  $R_{DS(ON)}$ , low gate charge and operation with gate voltages as low as 2.5V. This device is suitable for use as a load switch or in PWM applications. It is ESD protected.

### Application

- Uni-directional load switch
- Bi-directional load switch

### General Features

- $V_{DS} = 20V, I_D = 6.5A$
- $R_{DS(ON)} < 18\text{ m}\Omega$  (Typ) @  $V_{GS} = 4.5V$
- $R_{DS(ON)} < 18.5\text{ m}\Omega$  (Typ) @  $V_{GS} = 3.7V$
- $R_{DS(ON)} < 19.5\text{ m}\Omega$  (Typ) @  $V_{GS} = 3.1V$
- $R_{DS(ON)} < 21\text{ m}\Omega$  (Typ) @  $V_{GS} = 2.5V$
- High power and current handling capability
- Lead free product is acquired
- Surface mount package
- ESD Rating: 2000V HBM

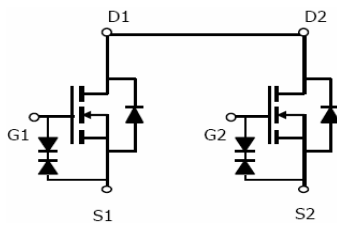

Schematic diagram

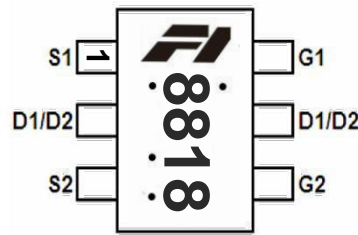

Marking and pin Assignment

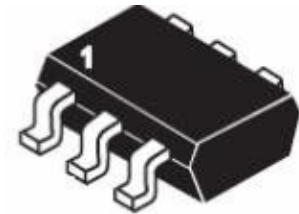

SOT23-6 top view

### Absolute Maximum Ratings ( $T_A = 25^\circ\text{C}$ unless otherwise noted)

Parameter	Symbol	Limit	Unit
Drain Source Voltage	$V_{DS}$	20	V
Gate Source Voltage	$V_{GS}$	$\pm 12$	V
Drain Current Continuous	$I_D$	6.5	A
Drain Current-Pulsed (Note 1)	$I_{DM}$	26	A
Maximum Power Dissipation	$P_D$	1.25	W
Operating Junction and Storage Temperature Range	$T_J, T_{STG}$	-55 To 150	$^\circ\text{C}$

### Thermal Characteristic

Thermal Resistance, Junction-to-Ambient (Note 2)	$R_{\theta JA}$	100	$^\circ\text{C/W}$
--	-----------------	-----	--------------------

### Electrical Characteristics (T<sub>A</sub>=25°C unless otherwise noted)

Parameter	Symbol	Condition	Min	Typ	Max	Unit
<b>Off Characteristics</b>						
Drain-Source Breakdown Voltage	BV <sub>DSS</sub>	V <sub>GS</sub> =0V, I <sub>D</sub> =250μA	20			V
Zero Gate Voltage Drain Current	I <sub>DSS</sub>	V <sub>DS</sub> =18V, V <sub>GS</sub> =0V	-	-	1	μA
Gate-Body Leakage Current	I <sub>GSS</sub>	V <sub>GS</sub> =±12V, V <sub>DS</sub> =0V	-	-	±10	μA
<b>On Characteristics</b> <sup>(Note 3)</sup>						
Gate Threshold Voltage	V <sub>GS(th)</sub>	V <sub>DS</sub> =V <sub>GS</sub> , I <sub>D</sub> =250μA	0.45	0.7	1.0	V
Drain-Source On-State Resistance	R <sub>DS(on)</sub>	V <sub>GS</sub> =4.5V, I <sub>D</sub> =4.5A		18	19.5	mΩ
		V <sub>GS</sub> =3.7V, I <sub>D</sub> =4A	-	18.5	20.5	mΩ
		V <sub>GS</sub> =3.1V, I <sub>D</sub> =4A	-	19.5	22	mΩ
		V <sub>GS</sub> =2.5V, I <sub>D</sub> =2A	-	21	25	mΩ
Forward Transconductance	g <sub>FS</sub>	V <sub>DS</sub> =5V, I <sub>D</sub> =6A	-	35	-	S
<b>Dynamic Characteristics</b> <sup>(Note 4)</sup>						
Input Capacitance	C <sub>iss</sub>	V <sub>DS</sub> =10V, V <sub>GS</sub> =0V, F=1.0MHz		993		PF
Output Capacitance	C <sub>oss</sub>		-	210	-	PF
Reverse Transfer Capacitance	C <sub>rss</sub>			139		PF
<b>Switching Characteristics</b> <sup>(Note 4)</sup>						
Turn-on Delay Time	t <sub>d(on)</sub>	V <sub>DD</sub> =10V, R <sub>L</sub> =1.2Ω V <sub>GS</sub> =8V, R <sub>GEN</sub> =3Ω	-	2.5		nS
Turn-on Rise Time	t <sub>r</sub>		-	7.2		nS
Turn-Off Delay Time	t <sub>d(off)</sub>		-	49		nS
Turn Off Fall Time	t <sub>f</sub>		-	10.8		nS
Total Gate Charge	Q <sub>g</sub>	V <sub>DS</sub> =10V, I <sub>D</sub> =6A, V <sub>GS</sub> =4.5V	-	14.2		nC
Gate-Source Charge	Q <sub>gs</sub>		-	1.5	-	nC
Gate-Drain Charge	Q <sub>gd</sub>		-	4.7	-	nC
<b>Drain-Source Diode Characteristics</b>						
Diode Forward Voltage <sup>(Note 3)</sup>	V <sub>SD</sub>	V <sub>GS</sub> =0V, I <sub>S</sub> =1A	-	-	1.2	V
Diode Forward Current <sup>(Note 2)</sup>	I <sub>S</sub>		-	-	3	A

#### Notes:

1. Repetitive Rating: Pulse width limited by maximum junction temperature.
2. Surface Mounted on FR4 Board, t ≤ 10 sec.
3. Pulse Test: Pulse Width ≤ 300μs, Duty Cycle ≤ 2%.
4. Guaranteed by design, not subject to production

### Typical Electrical and Thermal Characteristics

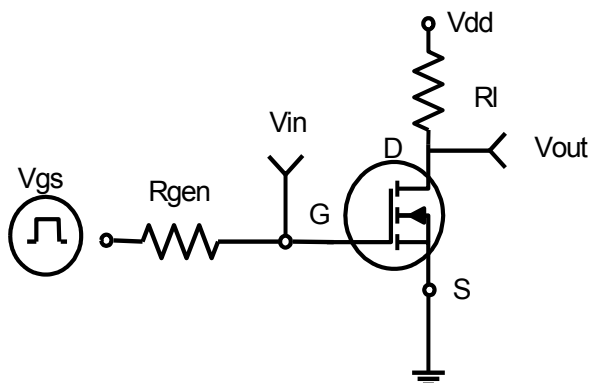

Figure 1: Switching Test Circuit

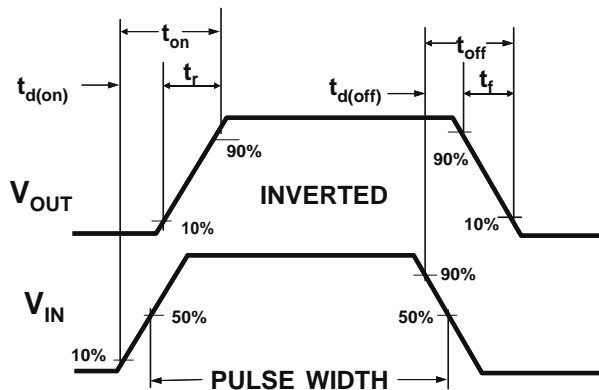

Figure 2: Switching Waveforms

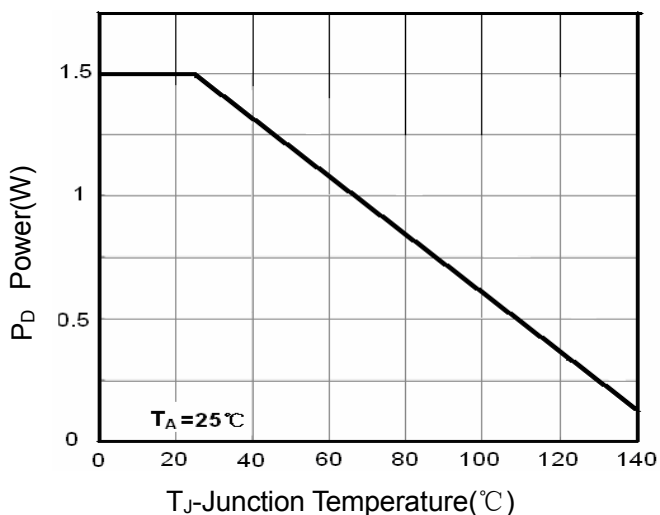

Figure 3 Power Dissipation

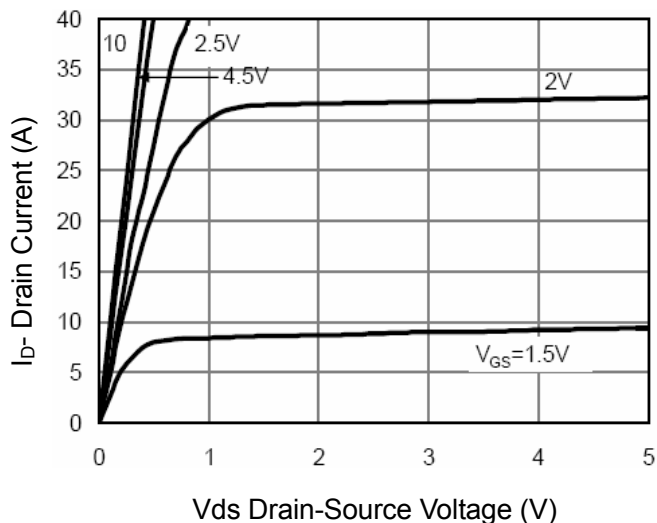

Figure 5 Output Characteristics

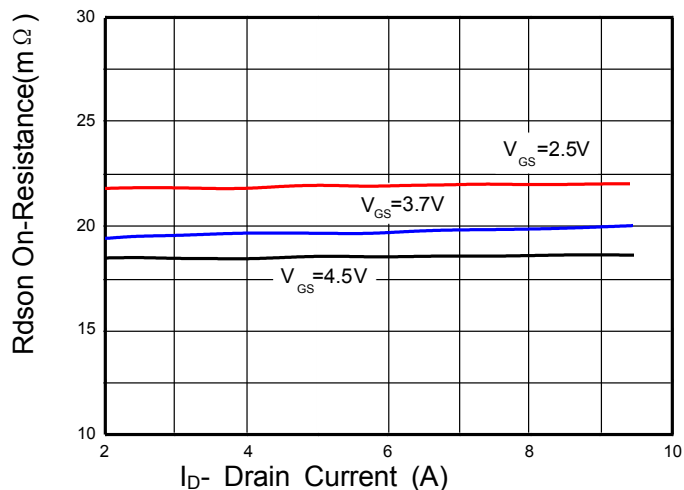

Figure 6 Drain-Source On-Resistance

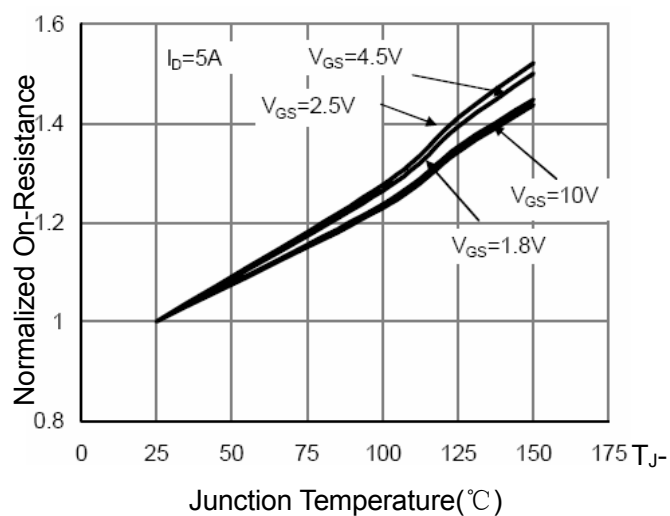
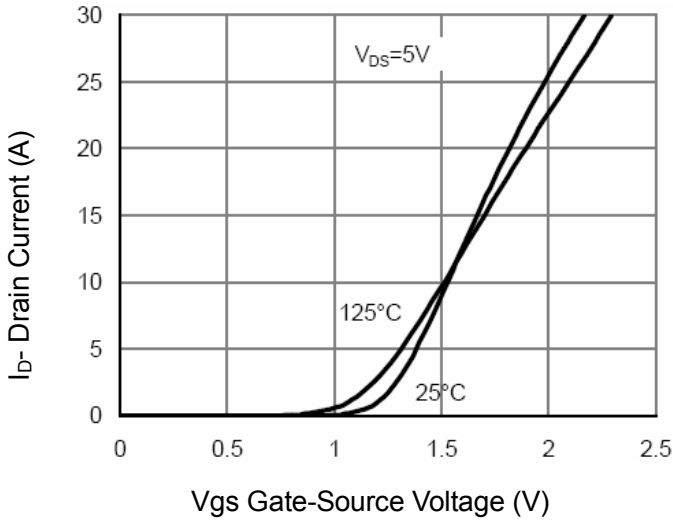
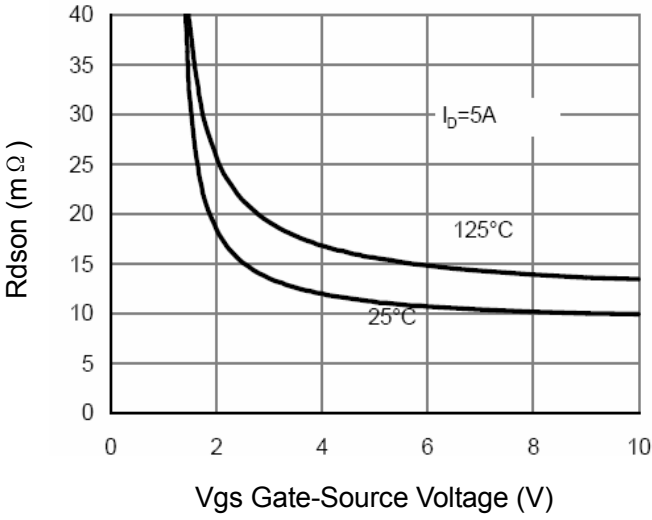

Figure 8 Drain-Source On-Resistance



**Figure 7 Transfer Characteristics**



**Figure 9  $R_{DS(on)}$  vs  $V_{GS}$**

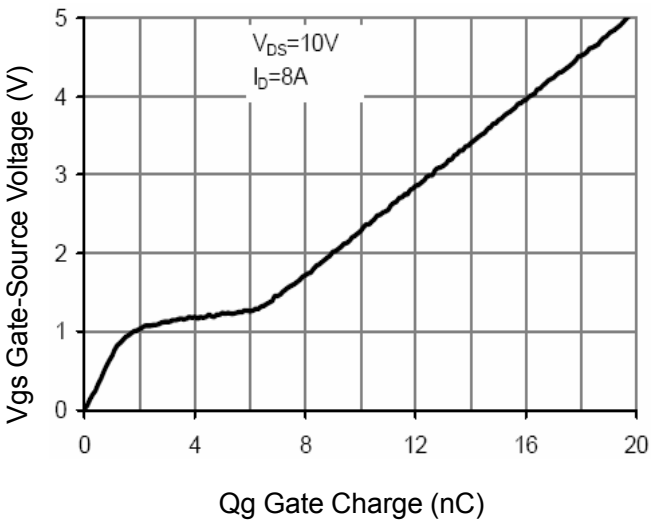

**Figure 11 Gate Charge**

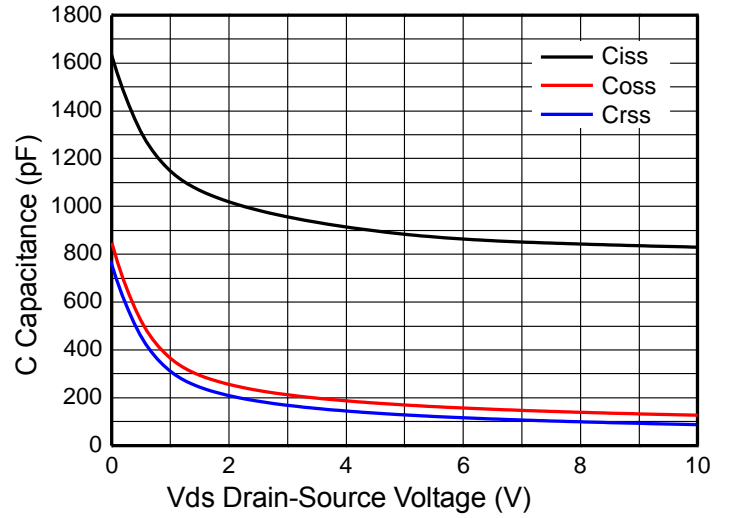

**Figure 8 Capacitance vs  $V_{DS}$**

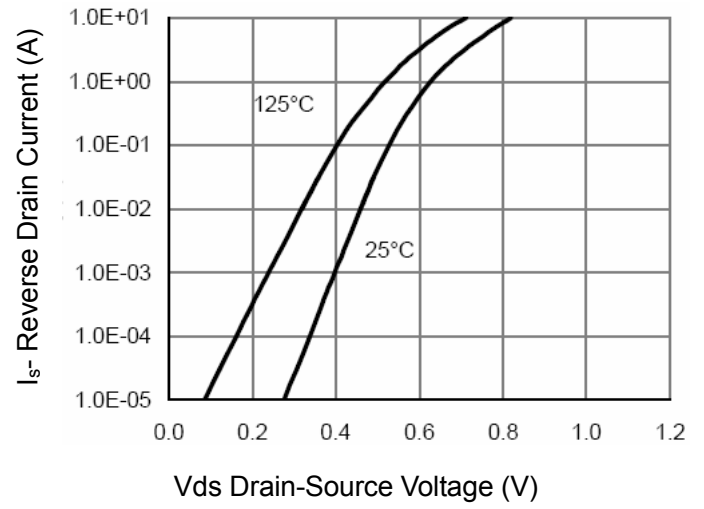

**Figure 10 Capacitance vs  $V_{DS}$**

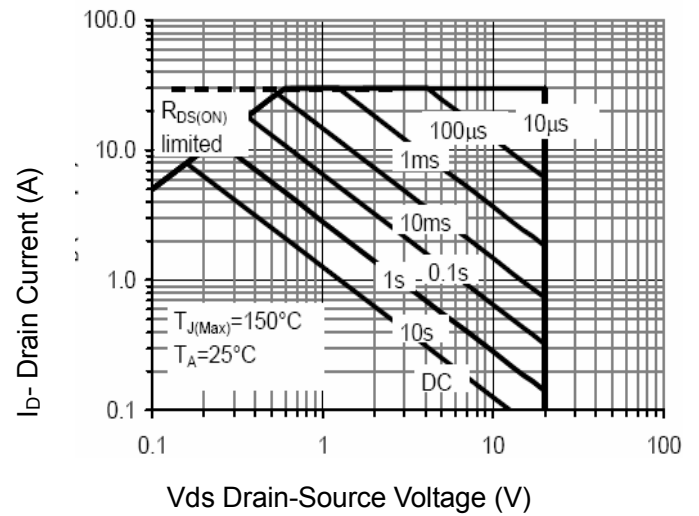

**Figure 13 Safe Operation Area**

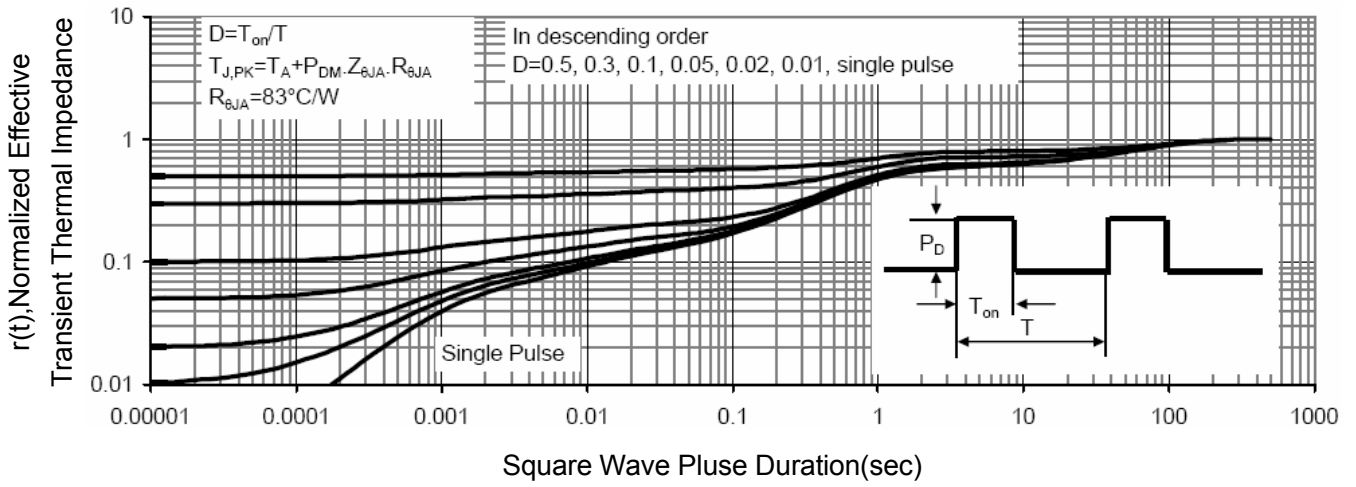
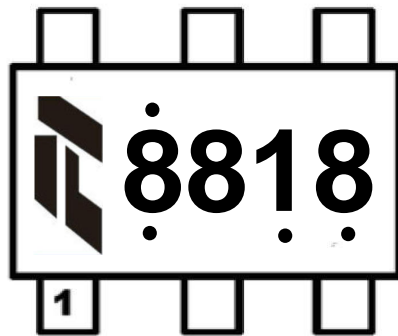

Figure 14 Normalized Maximum Transient Thermal Impedance

MARKING DESCRIPTION

SOT23-6



**Note:**

The printing points above and below the product model are the internal identification of the company. Each batch of products may be in different locations.

### Package Information : SOT23-6

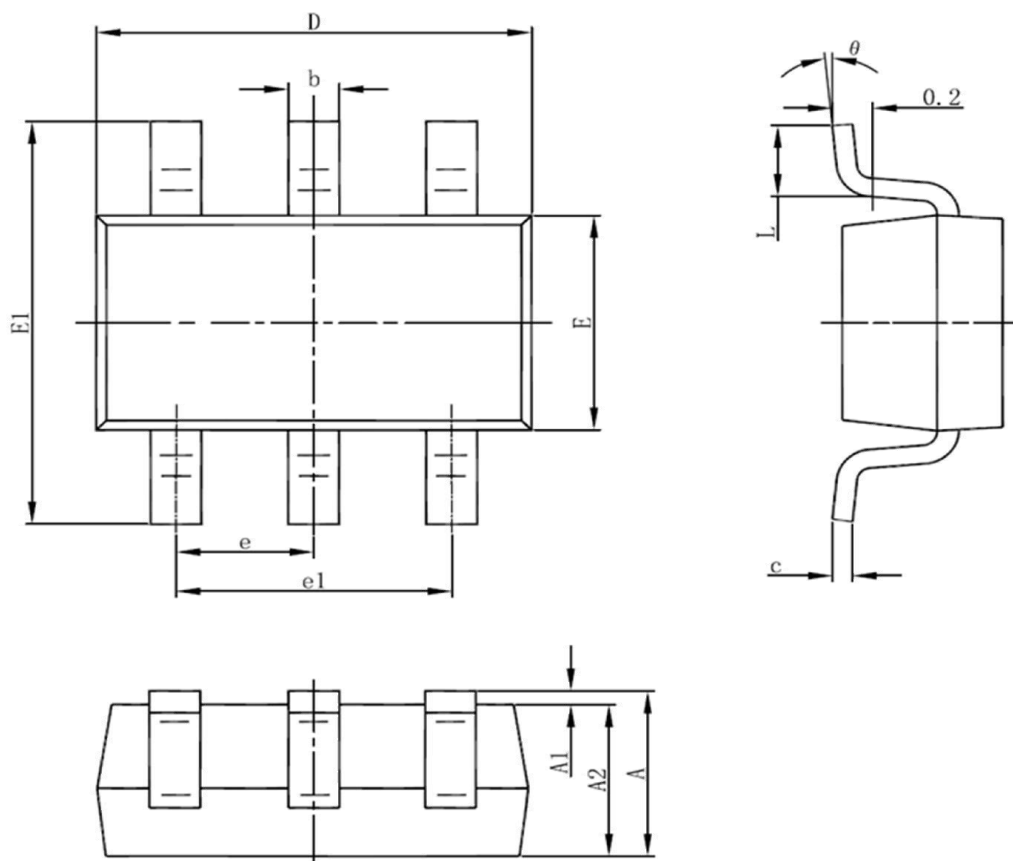

Symbol	Dimensions In Millimeters		Dimensions In Inches	
	Min	Max	Min	Max
A	1.050	1.250	0.041	0.049
A1	0.000	0.100	0.000	0.004
A2	1.050	1.150	0.041	0.045
b	0.300	0.500	0.012	0.020
c	0.100	0.200	0.004	0.008
D	2.820	3.020	0.111	0.119
E	1.500	1.700	0.059	0.067
E1	2.650	2.950	0.104	0.116
e	0.950(BSC)		0.037(BSC)	
e1	1.800	2.000	0.071	0.079
L	0.300	0.600	0.012	0.024
$\theta$	0°	8°	0°	8°

## X-ON Electronics

Largest Supplier of Electrical and Electronic Components

*Click to view similar products for [MOSFET](#) category:*

*Click to view products by [Xinfeihong](#) manufacturer:*

Other Similar products are found below :

[614233C](#) [648584F](#) [MCH3443-TL-E](#) [MCH6422-TL-E](#) [NTNS3A92PZT5G](#) [IRFD120](#) [IRFF430](#) [JANTX2N5237](#) [2N7000](#) [AOD464](#)  
[2SK2267\(Q\)](#) [2SK2545\(Q,T\)](#) [405094E](#) [423220D](#) [MIC4420CM-TR](#) [VN1206L](#) [614234A](#) [715780A](#) [SSM6J414TU,LF\(T](#) [751625C](#)  
[IPS70R2K0CEAKMA1](#) [BSF024N03LT3 G](#) [PSMN4R2-30MLD](#) [TK31J60W5,S1VQ\(O](#) [2SK2614\(TE16L1,Q\)](#) [DMN1017UCP3-7](#)  
[EFC2J004NUZTDG](#) [FCAB21350L1](#) [P85W28HP2F-7071](#) [DMN1053UCP4-7](#) [NTE2384](#) [NTE2969](#) [NTE6400A](#) [DMC2700UDMQ-7](#)  
[DMN2080UCB4-7](#) [DMN61D9UWQ-13](#) [US6M2GTR](#) [DMN31D5UDJ-7](#) [SSM6P54TU,LF](#) [DMP22D4UFO-7B](#) [IPS60R3K4CEAKMA1](#)  
[DMN1006UCA6-7](#) [DMN16M9UCA6-7](#) [STF5N65M6](#) [IRF40H233XTMA1](#) [IPSA70R950CEAKMA1](#) [IPSA70R2K0CEAKMA1](#) [STU5N65M6](#)  
[C3M0021120D](#) [DMN6022SSD-13](#)