

5050 幻彩透明(普亮) 贴片式发光二极管**特点 (Characteristics) :**

- * 外观尺寸 (L/W/H) :5.0*5.0*1.6mm
outline Dimensions (L / w / h): 5.0*5.0*1.6mm
- * 发光颜色及胶体: 七彩幻彩/透明胶体
Luminous color and colloid: Colorful magic/Transparent colloid
- * 环保工艺符合 ROHS 要求
Environmental protection products Complied With ROHS Directive
- * 湿气敏感性等级 (MSL) :5a 级
Moisture sensitivity level (MSL) : 5a levels
- * EIA 规范标准包装
EIA standard packaging
- * 适用于 SMT 贴片自动化生产
Suitable for SMT automatic production
- * 适用于红外线回流焊制程

**应用领域 (Product application) :**

- * LED 全彩发光字灯串
Led full-color luminous word lamp string,
- * LED 全彩模组
led full-color module
- * LED 幻彩软硬灯条, LED 护栏管
Led magic color soft and hard light strip, LED guardrail tube
- * LED 外观, 情景照明
Led appearance, scene lighting
- * LED 异性屏
Led heterosexual screen
- * 各种电子产品, 电器设备跑马灯
All kinds of electronic products, electrical equipment, runninglights



WS2812b 功能特点/ws2812b Functional characteristics:

1. 灯珠内部集成高质量外控单线级联恒流 IC 和优质 RGB LED 芯片，体积小，外围简单。

The ball interior integrates high-quality external single-line cascade IC and high-quality RGB LED chips, which are small in size and simple on the periphery.

2. 内置 IC 恒流精度高，内部 RGB 芯片预先分光处理。发光高度一致，白光效果纯正。

BUILT-IN IC constant current high precision, internal RGB chip pre-optical processing. High Degree of uniformity of light, white light effect pure.

3. 整形转发强化技术，单线数据传输，可无限级联。

Plastic forwarding enhancement technology, single-line data transmission, can be cascaded.

4. 数据传输频率 800Kbps/秒，可实现画面刷新速率 30 帧 / 秒时，不小于 1024 点。

The data transmission frequency is 800Kbps per second, and the screen refresh rate can be achieved at 30 frames per second, not less than 1024 points.

5. 输出端口 PWM 控制能够实现 256 级灰度调节，端口扫描频率 1.5KHz / s。

The output port PWM control can achieve 256 levels of grayscale adjustment, and the port scan frequency is 1.5 KHz / S.

6. 采用优化预置 12mA/通道恒流模式，低压驱动级联数量最大化。高恒流精度，片内误差 < 1.5%，片间误差 < 3%。Optimized preset 12mA / channel constant current mode is adopted to maximize the number of low-voltage drive cascades. High constant current accuracy, intraslice error < 1.5 %, interslice error < 3 %.

7. 内置低压强化模块，VDD 在 4.5-5.5V 以上 100%正常工作。

With the built-in low-pressure reinforcement module, VDD is 100 % functional above 4.5-5.5 V.

8. 超强数据整形能力：接受完本单元数据自动将后续数据整形输出。

Super data shaping ability: accept this unit data automatically will follow the data shaping output.



目录

Catalogue

电性参数	
Electrical Characteristics.....	3
典型特性曲线	
Typical Characteristic Curves.....	9
可靠性实验	
Reliability Test Items And Conditions.....	10
外形尺寸	
Outline Dimensions.....	11
包装	
Packaging.....	12
焊接指导	
Guideline for Soldering.....	14
使用注意事项	
Precautions.....	16



电性参数

Electrical Characteristics

极限参数 (Ta=25℃) Absolute Maximum Rating (ta=25 °C)

电气参数 Electrical parameters	符号 Symbol	极限范围 limit range	单位 Unit
供电电压 Supply Voltage	VDD	-0.5-5.5	V
逻辑输入电压 Logic input Voltage	VDI	3.0 -7.0	V
RGB 输出端口耐压 RGB Output port withstand voltage	V _{OUT}	7	V
RGB 输出电流 RGB Output current	I _{OL1}	12	mA
工作温度 Operating Temperature	T _{opr}	-30 ~ +70℃	
存储温度 Storage Temperature	T _{stg}	-40 ~ +80℃	
回流焊温度 Circle solder Temperature	T _{sol}	260℃ For 6 Seconds	
抗静电能力 ESD Sensitivity	ESD	4000V HBM	

光电特性参数 (Ta=25℃) Optical-electrical parameter (ta=25 °C)

参数名称 Parameter	颜色 Colour	符号 Symbol	测试条件 Test conditions	最小值 Min	典型值 Typ	最大值 Max	单位 Unit
光强 light intensity	红 red	IV	IF=12mA	400	-	600	mcd
	绿 green			1000	-	1400	
	蓝 blue			200	-	400	
主波长 Main wavelength	红 red	λ _D		620	-	630	nm
	绿 green			520	-	530	
	蓝 blue			465	-	475	
峰值波长 Peak wavelength	红 red	λ _P		620	-	625	nm
	绿 green			520	-	525	
	蓝 blue			465	-	470	
半光强视角 Half light angle	-	2θ _{1/2}	-	120	-	Deg	

电气参数 : Electrical parameters (ta=25 °C):

参数 Parameter	符号 Symbol	最小 Min	典型 Typ.	最大 Max	单位 Unit	测试条件 Test conditions
低电平输出电流 Low level output current	Iout	-	12	-	mA	R, G, B
输入电流 Input current	Ii	-	-	±1	µA	-
输出管脚电流 Output pin current	Isink	-	12	-	mA	-
高电平输入电压 High level input voltage	VIH	0.7Vdd	-	-	V	DIN, SET
低电平输入电压 Low level input voltage	VIL	-	-	0.3Vdd	V	DIN, SET
滞后电压 Hysteresis voltage	VH	-	0.35	-	V	DIN, SET
消耗功率 Consumed power	PD	-	200	-	mW	/
静态功耗 Static power onsumption	LDD	-	2	-	mW	/

开关特性 : Switching characteristics (ta=-40 ~ +85 °C):

参数 Parameter	符号 Symbol	最小 Min	典型 Typ	最大 Max	单位 Unit	测试条件 Test conditions
振荡频率 Frequency	Fosc	-	800	-	KHz	/
传输延迟时间 Transmission delay time	Tflz	-	-	500	ns	CI = 15 pF, DIN → DOUT, RI = 10 kΩ
下降时间 Descent time	Tthz	-	-	120	µs	CI = 300 pF, OUTR/OUTG/OUTB
数据传输率 Data transmission rate	Fd	800	-	1100	Kbps	占空比 50% 50% duty cycle
输入电容 Input capacitance	CI	-	-	15	pF	/

芯片级联方法: Chip cascade method:

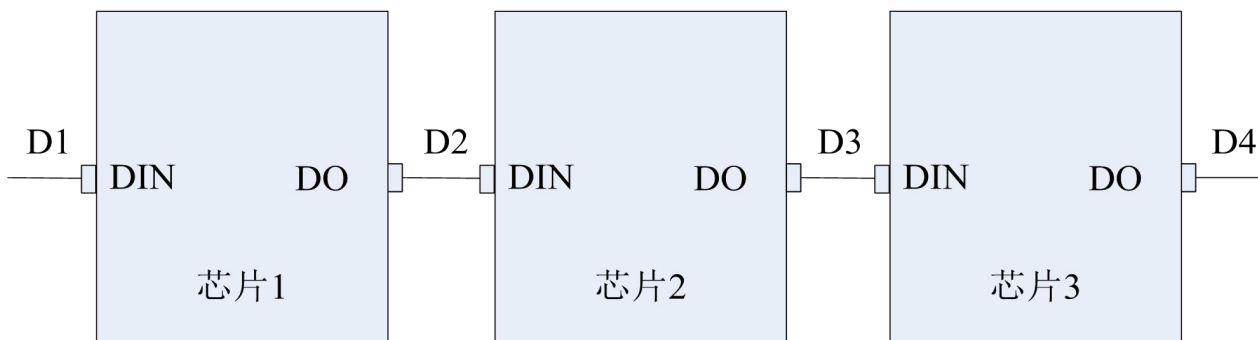

数据传输方式: Date transmission mode

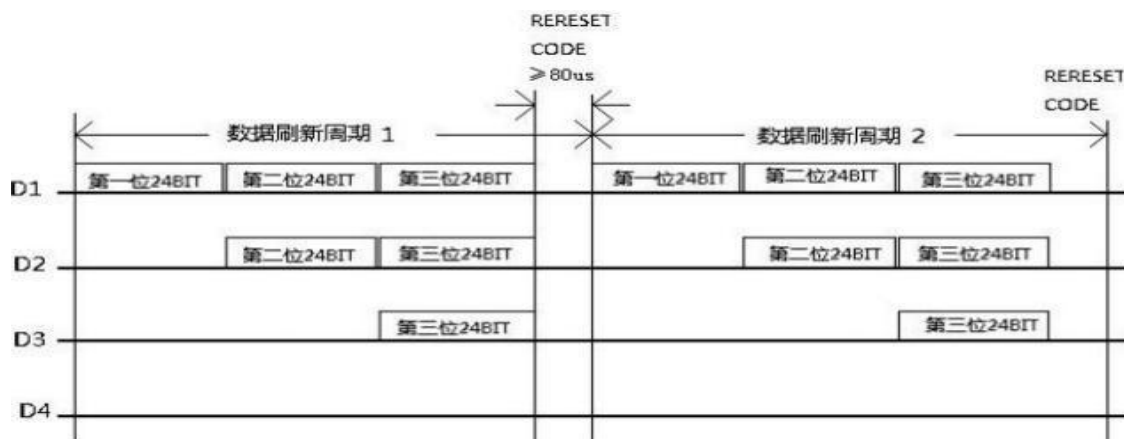

注: 其中 D1 为 MCU 端发送的数据, D2、D3、D4 为级联电路自动整形转发的数据

Note: D1 refers to the data sent by MCU, and D2, D3 and D4 refer to the data automatically shaped and forwarded by cascade circuit

24bit 数据结构: 24bit data structure:

G	G	G	G	G	G	G	G	R	R	R	R	R	R	R	R	B	B	B	B	B	B	B	
7	6	5	4	3	2	1	0	7	6	5	4	3	2	1	0	7	6	5	4	3	2	1	0

注: 高位先发, 按照 GRB 的顺序发送数据

Note: high order first send, send data in the order of GrB

数据时序波形图:Time sequence waveform:

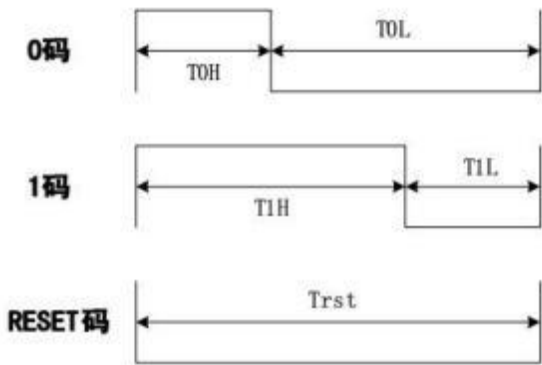

数据传输定义:Signal transmission definition

参数 Parameter	符号 Symbol	最小值 Min	最大值 Max	单位 Unit	最小值 Min
输入 0 码高电平时间 Input 0 code high level time	Tin0h	0.20	0.3	0.4	us
输入 1 码高电平时间 Input 1 code high level time	Tin1h	0.55	0.6	1.2	us
输入 0 码低电平时间 Input 0 code low level time	TOL	0.55	0.6	1.2	us
输入 1 码低电平时间 Input 1 code low level time	T1L	0.2	0.3	0.4	us
RESET 码低电平时间 Reset code low level time	reset	80	-	-	us

注/Note:

a: LED 灯珠主要根据高电平时间判断“0”码和“1”码。高电平时间介于 200ns~410ns, IC 判断为“0”码, 高电平时间介于 640ns~1000ns, 判断为“1”码。“0”码和“1”码的低电平代表此码结束, 准备接收下一数据码。 a: LED is mainly based on high-voltage flat time to determine “0” code and “1” code. The high power level time is between 200ns ~ 410ns, IC is judged to be “0” code, high power level time is between 640ns ~ 1000ns, and it is judged to be “1” code. The low levels of the “0” code and the “1” code represent the end of this code and are ready to receive the next data code.

b: 低电平复位时间最小为 100us, 为了留有余度, 一帧数据传输过程中(包括 24bit 和 24bit 之间、bit 和 bit 之间)不要中断超过 35us, 否则可能会被 IC 认为是 RESET。中断时间在 35us 之内, 控制器可以进行正常数据传输等其他操作。 b: The low flat reset time is a minimum of 100us. In order to leave a margin, do not interrupt more than 35us during a frame data transmission(including between 24bit and 24bit, between bit and bit), otherwise it may be considered by IC as RESET. The interrupt time is within 35us, and the controller can perform other operations such as normal data transmission.

控制器时序建议值：Recommended value of controller timing

名称 name	描述 Description	典型值 Typical value	建议设定值 Recommended setting value
T0H	0 码, 高电平时间 0 code, high level time	0.28us	0.28us
T1H	1 码, 高电平时间 1code, high level time	0.9us	0.9us
T0L	0 码, 低电平时间 0 code, low level time	>1.72μs	1.72μs
T1L	1 码, 低电平时间 1 code, low level time	>1.1us	1.1μs
T	“0” 码或 “1” 码周期 "0" code or "1" code cycle	>2.0us	--
reset	Reset 码, 低电平时间 Reset code, low level time	>30us	80us

应用线路图：Application circuit diagram:

1. 不加电容电阻线路示意图

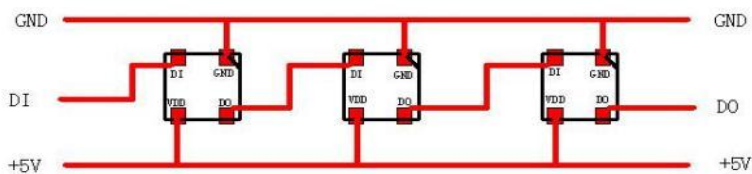

2. 加电容电阻线路示意图

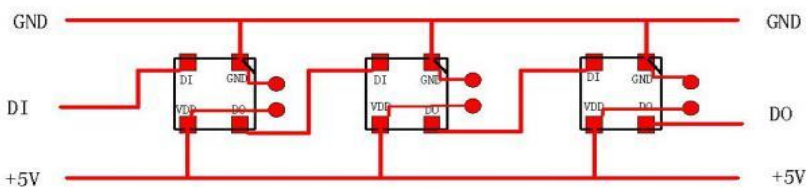

3. 过认证线路示意图

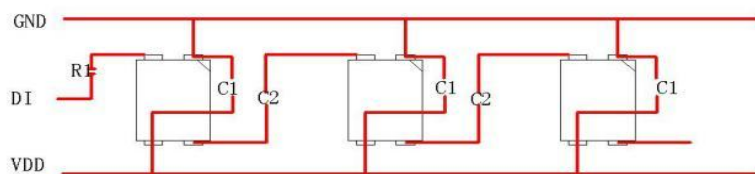

注：R1用450~700 欧电阻，电容C1 C2根据成品调试选用合适电容

典型特性曲线

Typical Characteristics Curves

Spectral Distribution

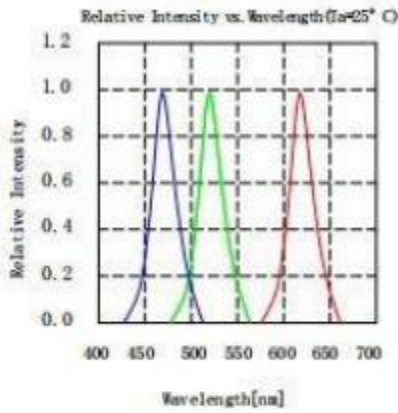

Forward current vs. Forward Voltage (Ta=25°C)

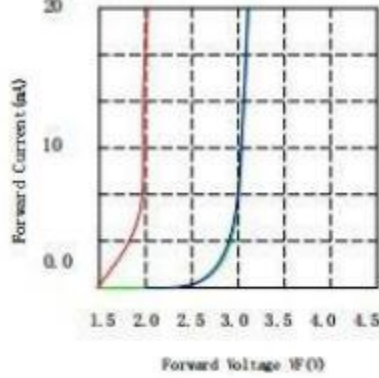

Relative Intensity vs. Forward Current (Ta=25°C)

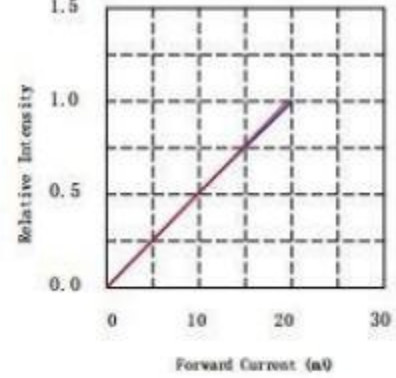

Derating

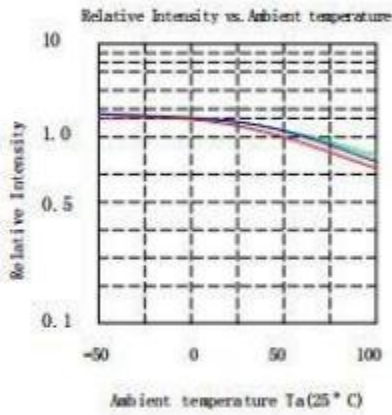

Ambient temperature vs. Maximum Forward Current

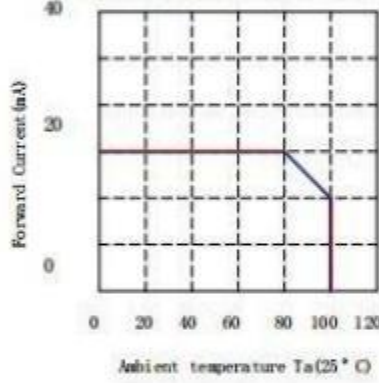

Forward Current vs. Chromaticity (Ta=25°C)

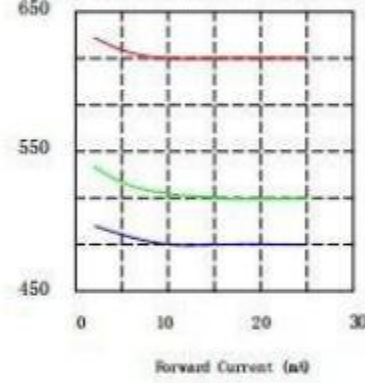
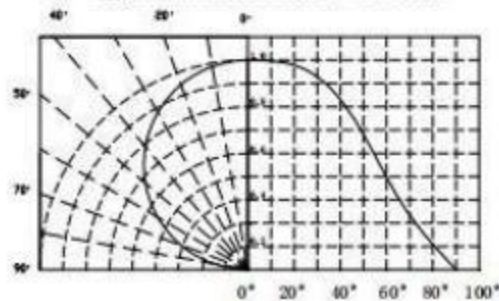

Diagram characteristics of radiation



可靠性试验

Reliability Test Items And Conditions

*可靠性实验项目 Reliability Test Project

描述 Description	项目 Item	测试标准 Test criterion	测试条件 Test condition	测试时间 Testtime	数量 Qty	失效数量 Fail qty
寿命测试 Life test	常温寿命测试 Life test(room temperature)	JIS7021:B4	Ta=25°C±5°C, IF=20mA	1000Hrs	22	0
环境测试 Ambience test	高温存储 High temperature store	JIS7021:B10 MIL-STD-202:210A MIL-STD-750:2031	Ta=85°C±5°C	1000Hrs	22	0
	低温存储 Low temperature store	JIS7021:B12	Ta=-35°C±5°C	1000Hrs	22	0
	高温高湿测试 High temperature/ humidity test	JIS7021:B11 MIL-STD-202:103D	Ta=85°C±5°C RH=85%	1000Hrs	22	0
	冷热冲击测试 Cold / Heat strike test	JIS7021::B4 MIL-STD-202:107D MIL-STD-750:1026	30min -10°C±5°C←→100°C± 5°C 5min 5min	50Cycles	22	0
	冷热循环测试 Cold and heat cycle test	JIS7021:A3 MIL-STD-202:107D MIL-STD-705:105E	5min 5min 5min -35°C~25°C~85°C~ -35°C 30min 5min 30min 5min	50Cycles	22	0

*判断标准 Judging criterion:

项目 Item	符号 Symbol	实验条件 Experiment condition	判断标准 Criteria	
			Min.	Max.
Forward Voltage 正向电压	VF	IF=20mA	----	Initial Datex1.1
Reverse Current 反向电流	IR	VR=5V	----	5 μ A
Luminous Intensity 发光强度	IV	IF=20mA	Initial Datex0.7	----

外形尺寸

Outline Dimension

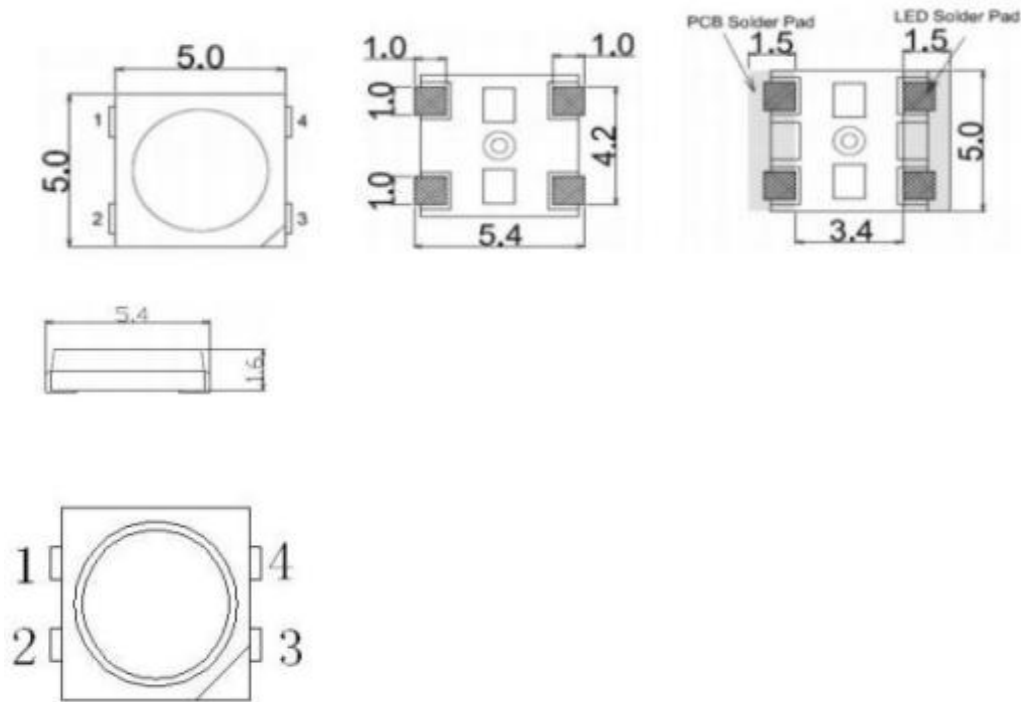

备注： 1. 以上尺寸单位均为 mm

Remarks: All dimensions are in millimeters.

2. 未特别标注公差尺寸公差均为±0.2mm

Tolerance is ±0.25mm unless otherwise noted

引脚电路图及引脚功能:

序号 Serial number	符号 Symbol	功能描述 Function description
1	VDD	内部IC电源正及RGB正极 Internal IC power positive and RGB positive
2	DI	显示数据输入 Display data input
3	GND	信号地及电源地 Signal ground and power ground
4	DO	显示数据级联输出 Display data cascade output

包装 (1)

Packaging (1)

载带与圆盘尺寸 Belt and disk dimensions

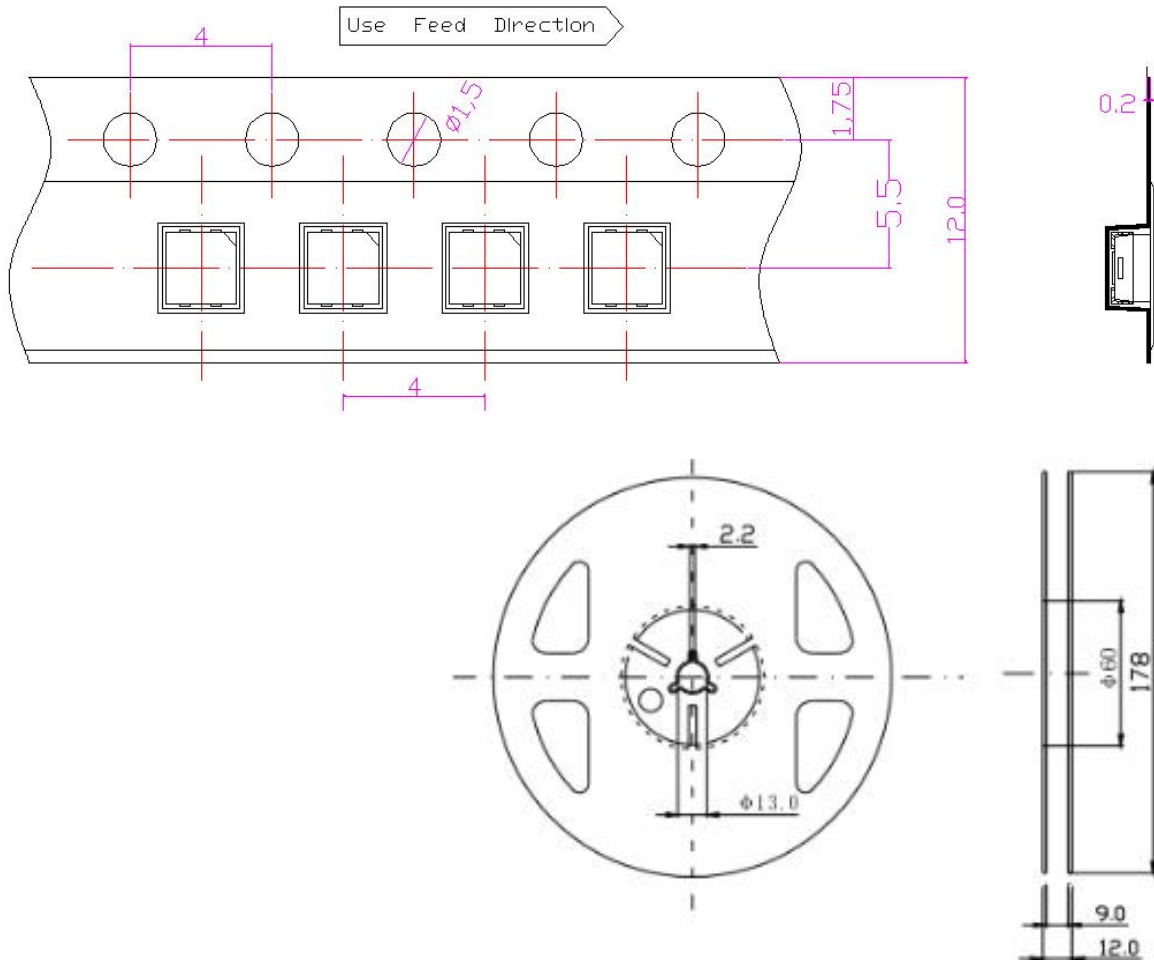

备注： 1. 以上尺寸单位均为 mm

Remarks: All dimensions are in millimeters.

2. 未特别标注公差尺寸公差均为 $\pm 0.25\text{mm}$

Tolerance is $\pm 0.25\text{mm}$ unless otherwise noted

◆ 圆盘及载带卷出方向及空穴规格 Disk and carrier belt direction of roll and hole dimensions

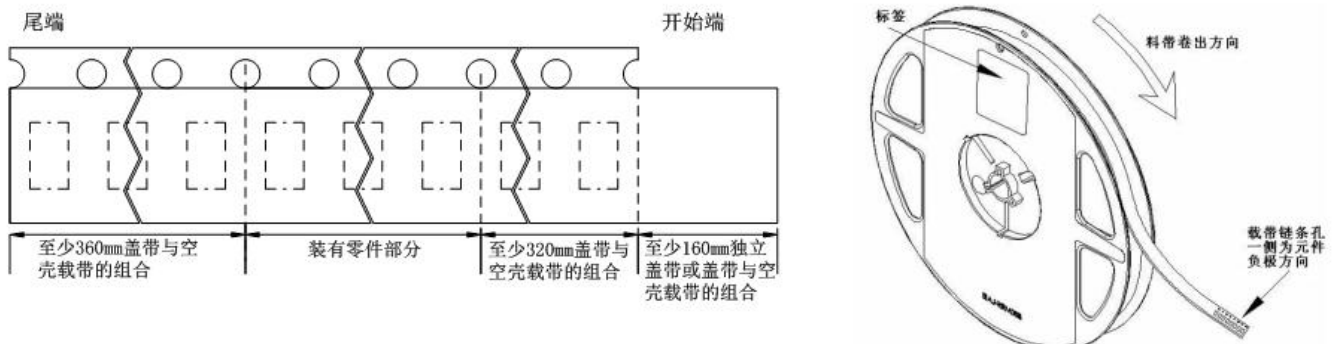

包装 (2)

Packaging (2)

◇ 防潮防静电包装 Moisture Proof and Anti-Electrostatic Foil Bag

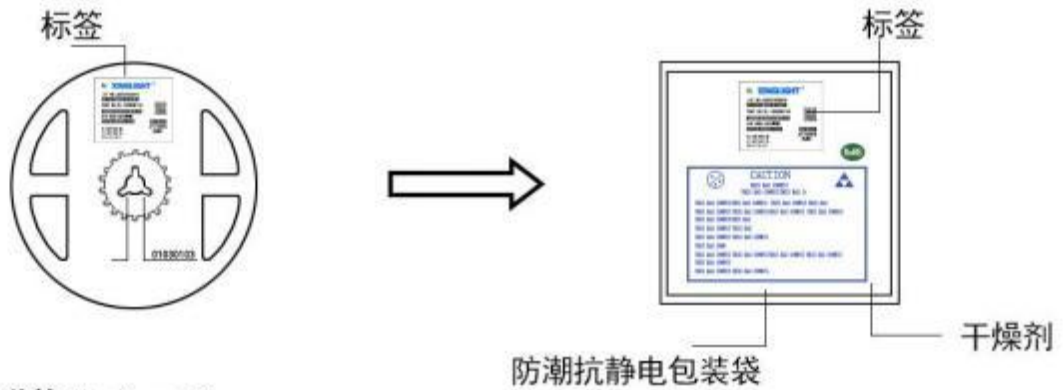

◇ 外包装箱 Cardboard Box

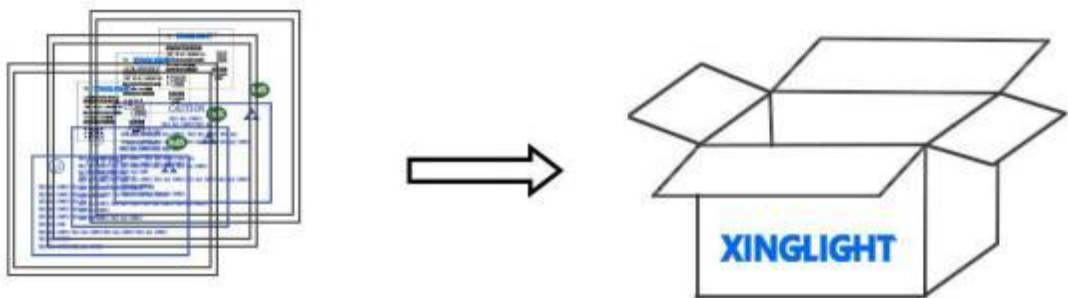

Capacity 5 or 10 reels per box (内箱容量: 50或100卷)

◇ 标签说明: Label Explanation

- LOT NO: 批次信息
- PART NO: 产品型号
- BIN CODE: 产品名称
- WL: 波长范围
- IV: 光强范围
- VF: 电压范围



焊接指导 (1)

Guideline for Soldering (I)

1. 使用烙铁人手焊接

Hand Soldering

只建议在修理和重工的情况下使用手工焊接；推荐使用功率低于 30 W 的烙铁，焊接时烙铁的温度必须保持在 300℃ 以下，且每个电极只能进行一次焊接，每次焊接的持续时间不得超过 3 秒。

人手焊接过程中的不慎操作易引起 LED 产品的损坏，应当小心谨慎。

Manual welding is recommended only for repair and heavy industry situations. A soldering iron of less than 30W is recommended to be used in Hand Soldering. Please keep the temperature of the soldering iron under 300°C while soldering. Each terminal of the LED is to go for less than 3 second and for one time only.

Be careful because the damage of the product is often started at the time of the hand soldering.

2. 回流焊接： 推荐使用以下无铅回流焊接温度图进行。

Reflow Soldering: Use the conditions shown in the under Figure of Pb -Free Reflow Soldering.

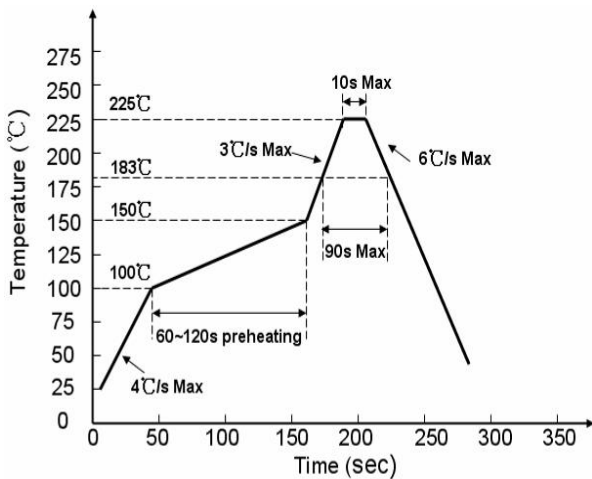

有铅制程 Lead process

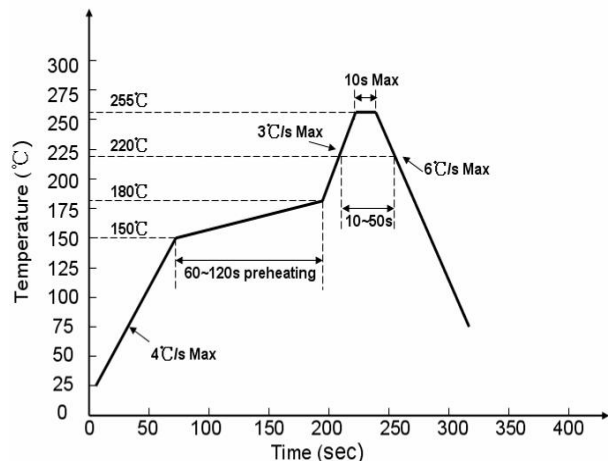

无铅制程 lead free

回流焊接最多只能进行两次。

Reflow soldering should not be done more than two times.

在回流焊接升温过程中，请不要对 LED 施加任何压力。

Stress on the LEDs should be avoided during heating in soldering process.

在焊接完成后，待产品温度下降到室温之后，再进行其他处理。

After soldering, do not deal with the product before its temperature drop down to room temperature.

焊接指导 (2)

Guideline for Soldering (2)

3. 清洗:

Cleaning

在焊接后推荐使用酒精进行清洗，在温度不高于 30°C 的条件下持续 3 分钟，不高于 50°C 的条件下持续 30 秒。

使用其他类似溶剂清洗前，请先确认使用的溶剂不会对 LED 的封装和环氧树脂部分造成损伤。超声波清洗也是有效的方法，一般最大功率不应超过 300W，否则可能对 LED 造成损伤。请根据具体的情况预先测试清洗条件是否会对 LED 造成损伤。

It is recommended that alcohol be used as a solvent for cleaning after soldering. Cleaning is to go under 30°C for 3 minutes or 50°C for 30 seconds. When using other solvents, it should be confirmed beforehand whether the solvents will dissolve the package and the resin or not.

Ultrasonic cleaning is also an effective way for cleaning. But the influence of Ultrasonic cleaning on LED depends on factors such as ultrasonic power. Generally, the ultrasonic power should not be higher than 300W. Before cleaning, a pretest should be done to confirm whether any damage to LEDs will occur.

*** 注意：** 此一般指导原则并不适用于所有 PCB 设计和焊接设备的配置。具体工艺受到诸多因素的影响，请根据特定的 PCB 设计和焊接设备来确定焊接方案。

*** Note:** This general guideline may not apply to all PCB designs and configurations of all soldering equipment. The technics in practise is influenced by many factors, it should be specialized base on the PCB designs and configurations of the soldering equipment..

使用注意事项 (1)

Precautions (1)**1. 贮存:****Storage**

- 本产品使用密封防潮抗静电袋包装，并附有干燥剂，未开封的产品有一年的保存时间。

Moisture proof and anti-electrostatic package with moisture absorbent material is used, to keep moisture to a minimum.

- 开封前，产品须存放在温度不高于 30℃，湿度不高于 60%RH 的环境中。

Before opening the package, the product should be kept at 30℃ or less and umidity less than 60% RH, and be used within a year.

- 开封后，产品须存放在温度不高于 30℃，湿度不高于 10%RH 的环境中，且应该在 168 小时（7 天）内使用完。建议工作环境为温度不高于 30℃，湿度不高于 60%RH。

After opening the package, the product should be stored at 30℃ or less and humidity less than 10%RH, and be soldered within 168 hours (7 days). It is recommended that the product be operated at the workshop condition of 30℃ or less and humidity less than 60%RH.

- 对于尚未焊接的 LED，如果吸湿剂或包装失效，或者产品没有符合以上有效存储条件，烘焙可以起到一定的性能恢复效果。烘焙条件：60±5) °C，持续24 小时。

If the moisture absorbent material has fade away or the LEDs have exceeded the storage time, baking treatment should be performed based on the following condition: (60±5)°C for 24 hours.

2. 静电:**Static Electricity**

静电和电涌会导致产品特性发生改变，例如正向电压降低等，如果情况严重甚至会损毁产品。所以在使用时必须采取有效的防静电措施。所有相关的设备和机器都应该正确接地，同时必须采取其他防止静电和电涌的措施。使用防静电手环，防静电垫子，防静电工作服、工作鞋、手套，防静电容器，都是有效的防止静电和电涌的措施。

Static electricity or surge voltage damages the LEDs. Damaged LEDs will show some unusual characteristic such as the forward voltage becomes lower, or the LEDs do not light at the low current. even not light.

All devices, equipment and machinery must be properly grounded. At the same time, it is recommended that wrist bands or anti-electrostatic gloves, anti-electrostatic containers be used when dealing with the LEDs.

使用注意事项 (2)

Precautions (2)

3. 设计建议:

Design Consideration

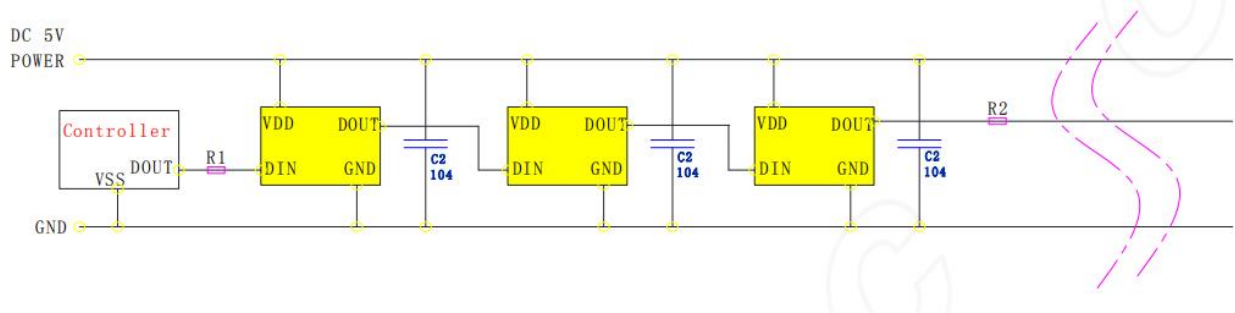

在实际应用电路中,为防止产品在测试时带电插拔产生的瞬间高压损伤 IC 内部电源及 信号输入输出脚,应在信号输入及输出端串接保护电阻。此外,为了使各 IC 芯片间更 稳定工作,各灯珠间的退偶电容则必不可少;

1. 产品两端所并的退偶电容一般不建议省略;
2. 产品的信号输入及输出端必需串接保护电阻 R1/R2,因线材及传输距离不同,在信号线两端串接的保护电阻会略有不同; R1/R2 的大小取决于级联灯珠的数量,级联数量越多,则 R1/R2 越小,灯珠间传输距离长,一般建议在 20-2K Ω 之间取值,建议通常建议取值 在 500 欧左右;以实际使用情况定; R2 可接地。

In practical application circuits,To prevent instantaneous high voltage generated by live plugging during product testing Damage to IC internal power supply and signal input/output pins Protective resistors should be connected in series at the signal input and output terminals .In addition, in order to ensure more stable operation between IC chips The decoupling capacitance between each lamp bead is essential:

- 1、 It is generally not recommended to omit the decoupling capacitors connected at both ends of the pr... ;
- 2、 The signal input and output terminals of the product must be connected in series with protective r...; Due to differences in wire material and transmission distance; The size of r1/r2 depends on the number of cascaded lamp beads , The more cascades, the smaller r1/r2 ; Long transmission distance between lamp beads , Generally recommended between 20-2k ω Value between , The recommended value is usually around 500 euros; Based on actual usage; R2 can be grounded .

使用注意事项 (3)

Precautions (3)

4. 其他事项:

Others

直接用手拿取产品不但会污染封装树脂表面,也可能由于静电等因素导致产品性能的改变。过度的压力也可能直接影响封装内部的管芯和金线,因此请勿对产品施加过度压力,特别当产品处于高温状态下,例如在回流焊接过程中。

When handling the product, touching the encapsulant with bare hands will not only contaminate its surface, but also affect on its optical characteristics. Excessive force to the encapsulant might result in catastrophic failure of the LEDs due to die breakage or wire deformation. For this reason, please do not put excessive stress on LEDs, especially when the LEDs are heated such as during Reflow Soldering.

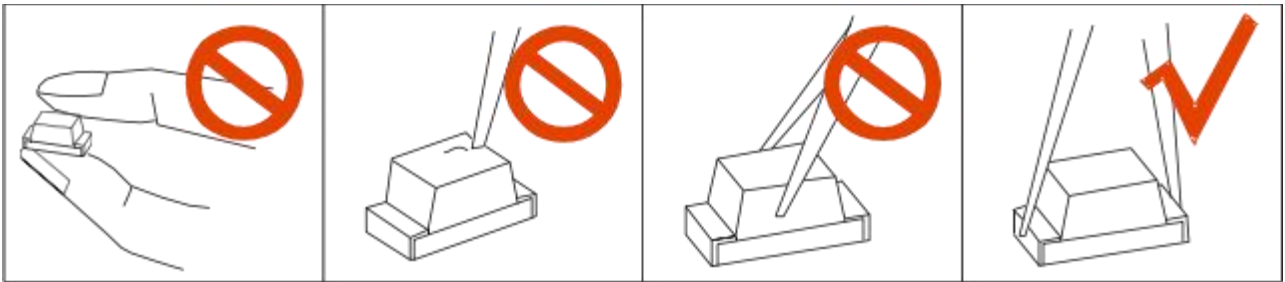

LED 的环氧树脂封装部分相当脆弱,请勿用坚硬、尖锐的物体刮、擦封装树脂部分。在用镊子夹取的时候也应当小心注意。

The epoxy resin of encapsulant is fragile, so please avoid scratch or friction over the epoxy resin surface.

While handling the product with tweezers, do not hold by the epoxy resin, be careful.

5. 眼睛保护忠告:

Safety Advice For Human Eyes

LED 发光时,请勿直视发光光源,特别是对于一些光强较高的 LED,强光可能伤害你的眼睛。

Viewing direct to the light emitting center of the LEDs, especially those of great Luminous Intensity, will cause great hazard to human eyes. Please be careful.

X-ON Electronics

Largest Supplier of Electrical and Electronic Components

Click to view similar products for [Standard LEDs - SMD category](#):

Click to view products by [XINGLIGHT manufacturer](#):

Other Similar products are found below :

[LTST-C190KYKT](#) [LTST-C19GD2WT](#) [LTW-170ZDC](#) [LTW-M140SZS40](#) [LTW-M140ZVS](#) [598-8110-100F](#) [598-8610-202F](#) [91-21SUBCS400-A6TR7](#) [AAAF5060QBFSEEZGS](#) [APT1608QGW](#) [99-213/R6C-AR2T1B/2C](#) [SML-LX0606SISUGC/A](#) [SML-LXR851SIUPGUBC](#) [LT1ED53A](#) [APFA3010SURKCGKQBDC](#) [APHK1608VGCA](#) [APT2012QGW](#) [LTST-008BGEW](#) [LTW-010DCG](#) [LTW-21TS5](#) [LTW-220DS5](#) [598-8330-117F](#) [65-21SYGC/S530-E3/TR8](#) [CMDA20AYAA7D1S](#) [95-21SURCS530-A3TR10](#) [598-8070-100F](#) [598-8140-100F](#) [598-8610-200F](#) [SML-LXR851SGSIC-TR](#) [SML-512PWT86A](#) [SMF-2432GYC-TR](#) [EASV3015RGYA0](#) [95-21UYC-S530-A5-TR7](#) [LTST-C190KFKT-5A](#) [LTST-C194TBKT-5A](#) [CLX6E-FKC-CH1M1D1BB7C3D3](#) [SML-LXL0805USBC-TR](#) [SML-LX2835SYSUGCTR](#) [LTW-M670ZVS-M5](#) [APA2106ZGC/G](#) [CLMXB-FKA-CbcfghjnpACBB79463](#) [KPTD-2012LVVBC-D](#) [VFA1101W-5AY3B2-TR](#) [LCB P473-P2R2-3J7L-1-Z](#) [91-21VGC/S556/S68/TR10/S370](#) [LW A67C-S2U1-FK0KM0](#) [LW A673-P1S1-FK0PM0](#) [BL-HE1G033B-TRB](#) [5988B90107F](#) [EL-19-21SURC/S530-A6](#)