

5050 幻彩+白光 贴片式发光二极管



特点 (Characteristics) :

- * 外观尺寸 (L/W/H) :5.0*5.0*1.6mm
outline Dimensions (L / w / h): 5.0*5.0*1.6mm
- * 发光颜色及胶体: 七彩幻彩/透明胶体
Luminous color and colloid: Colorful magic/Transparent colloid
- * 环保工艺符合 ROHS 要求
Environmental protection products Complied With ROHS Directive
- * 湿气敏感性等级 (MSL) :5a 级
Moisture sensitivity level (MSL) : 5a levels
- * EIA 规范标准包装
EIA standard packaging
- * 适用于 SMT 贴片自动化生产
Suitable for SMT automatic production
- * 适用于红外线回流焊制程

应用领域 (Product application) :

- * 全彩发光字
Full color luminous words
- * 全彩模组
Full color module
- * 点光源
Point light source
- * 全彩灯条
Full Light Bar
- * 像素屏、异形屏
Pixel screen、Shaped screen
- * 室内 LED 装饰照明
Indoor LED decorative lighting
- * 建筑 LED 外观/情景照明



1、产品概述/Product Overview:

5050 内封 IC-01W 是一款集成高质量单线传输四通道驱动 IC 和高质量 RGB 和白光 LED 芯片的外控恒流 5050 集成灯珠。其中内置控制 IC 具有高可靠，低功耗，抗干扰性能高和恒流精度高的特点，而内部集成优选高质量的 LED 芯片，具有发光一致性优良，白光效果纯正，光衰小的优点。此款灯珠将二者优点相结合，同时带来体积小，外围元件少，版面干净的特点。通过外部控制器控制，可展现幻彩，动画以及高标准视频效果。
/5050 IC-01W is an integrated high-quality single-line transmission four-channel driver IC and high-quality RGB and white LED chip external constant current 5050 integrated light beads. The built-in control IC has the characteristics of high reliability, low power consumption, high anti-interference performance and high constant current precision, while the internal integration of high-quality LED chip, with good uniformity of luminescence, white light effect pure, light-fading small advantages. This lamp ball will combine the advantages of the two, while bringing small size, less peripheral components, the layout of clean features. Controlled by external controller, it can display illusion, animation and high standard video effect.

2、功能特点/Functional characteristics:

- 2.1 5050 灯珠内部集成高质量外控单线传输四通道驱动 IC，优质 RGB 和白光 LED 芯片，体积小，外围简单。/5050 light bead internal integration of high-quality external control single-line transmission four-channel driver IC, high-quality RGB and white LED chips, compact size, simple peripheral.
- 2.2 内置 IC 恒流精度高，内部 RGB 芯片预先分光处理。发光高度一致，白光效果纯正。/BUILT-IN IC constant current high precision, internal RGB chip pre-optical processing. High Degree of uniformity of light, white light effect pure.
- 2.3 整形转发强化技术，单线数据传输，可无限级联。/Plastic forwarding enhancement technology, single-line data transmission, can be cascaded.
- 2.4 数据传输频率 800Kbps/秒，可实现画面刷新速率 30 帧 / 秒时，不小于 1024 点。/The data transmission frequency is 800Kbps per second, and the screen refresh rate can be achieved at 30 frames per second, not less than 1024 points.
- 2.5 输出端口 PWM 控制能够实现 256 级灰度调节，端口扫描频率 1.5KHz/s。/The output port PWM control can achieve 256 levels of grayscale adjustment, and the port scan frequency is 1.5 KHz / S.
- 2.6 采用优化预置输出恒流值：OUTR/G/B 为 8mA, OUTW 为 17mA，低压驱动级联数量最大化。高恒流精度，片内误差<1.5%，片间误差<3%。/The output constant current is optimized: OUTR/g/b is 8mA, OUTW is 17mA, and the number of low voltage driving cascades is maximized. High constant current accuracy, in-chip error & Lt; 1.5% , between-chip error & LT; 3% .
- 2.7 输出端口耐压：26V/OUTPUT PORT WITHSTAND VOLTAGE: 26V.
- 2.8 超强数据整形能力：接受完本单元数据自动将后续数据整形输出。/Super data shaping ability: accept this unit data automatically will follow the data shaping output.

目录

Catalogue

电性参数	
Electrical Characteristics.....	3
典型特性曲线	
Typical Characteristic Curves.....	9
可靠性实验	
Reliability Test Items And Conditions.....	11
外形尺寸	
Outline Dimensions.....	12
包装	
Packaging.....	13
焊接指导	
Guideline for Soldering.....	15
使用注意事项	
Precautions.....	17

电性参数

Electrical Characteristics

最大额定值 (如无特殊说明, $T_A = 25^\circ\text{C}$, $V_{SS} = 0\text{V}$)

参数	符号	范围	单位
电源电压	Vdd	-0.4 ~ +5.5	V
输出端口耐压	Vout	24	V
逻辑输入电压	Vi	-0.4 ~ Vdd + 0.4	V
工作温度	Topt	-40 ~ +85	°C
储存温度	Tstg	-40 ~ +100	°C
HBM 人体放电模式	VESD	>2	KV

注：散热表现与散热片尺寸、PCB 厚度与层数息息相关。实际应用条件下的热阻值会与测试值存在一定差异，使用者可选择适当的封装与 PCB 布局，以达到理想的散热表现。/Heat dissipation performance is closely related to fin size, PCB thickness and layer number. The thermal resistance value in practical application is different from the test value. Users can choose proper packaging and PCB layout to achieve the ideal heat dissipation performance.

电气参数 (如无特殊说明, $T_A = -40 \sim +85^\circ\text{C}$, $V_{SS} = 0\text{V}$, $V_{DD} = 4.5 \sim 5.5\text{V}$)

符号	参数	测试条件	最小值	典型值	最大值	单位
VDD	芯片工作电压	-	3.5	-	5.5	V
IDD	静态电流	VDD = 4.5V, IOUT "OFF"	-	1.0	-	mA
VIH	输入信号阈值电压	VDD=5V, 调节 DIN 输入电平	3.4	-	-	V
VIL			-	-	1.8	V
IOU _{TR/G/B/W}	OUT _{R/G/B} 端口驱动电流	VDS = 1.0V	-	8	-	mA
	OUT _W 端口驱动电流	VDS = 1.0V	-	17	-	mA
%VS. VDS	OUT R/G/B/W 输出电流变化量	VDS = 1.0 ~ 3.0V	-	0.5	-	%
%VS. VDD		VDD = 4.5 ~ 5.5V	-	0.5	-	%
%VS. TA		TA = -40 ~ +85°C	-	5.0	-	%
I _{leak}	OUT R/G/B/W 端口漏电流	VDS = 30V, IOUT "OFF"	-	-	1	uA

注：1. 电气工作参数定义了器件在工作范围内并且在保证特定性能指标的测试条件下的直流和交流电参数。对于未给定上下限值的参数，该规范不予保证其精度，但其典型值合理反映了器件性能。Electrical operating parameters define the DC and AC electrical parameters of the device within its operating range and under test conditions that guarantee specific performance indicators. The specification does not guarantee the accuracy of the parameters for which no upper and lower limits are given, but the typical values reasonably reflect the performance of the device

2. 规格书的最小、最大参数范围由测试保证，典型值由设计、测试或统计分析保证。/The minimum and maximum ranges of specifications are guaranteed by testing, and typical values are guaranteed by design, testing, or statistical analysis.

开关特性 : Switching characteristics (ta=-40 ~ +85 °C):

符号	参数	测试条件	最小值	典型值	最大值	单位
fPWM	OUT R/G/B 输出 PWM 频率	IOUT=12mA, OUT 端口串接 200 Ω 电阻至 VDD	-	1.2	-	KHz
tPLH	信号传输延时 (注)	DOUT 端口对地负载电容 30pF, DIN 至 DOUT 的信号传输延时	-	500	-	ns
tPHL			-	500	-	ns
tr	OUTG 转换时间 (注)	IOUT G =12mA, OUT G 端口串接 200 Ω 电阻至 VDD, 对地负载电容 30pF	-	18	-	ns
tf			-	110	-	ns

注:

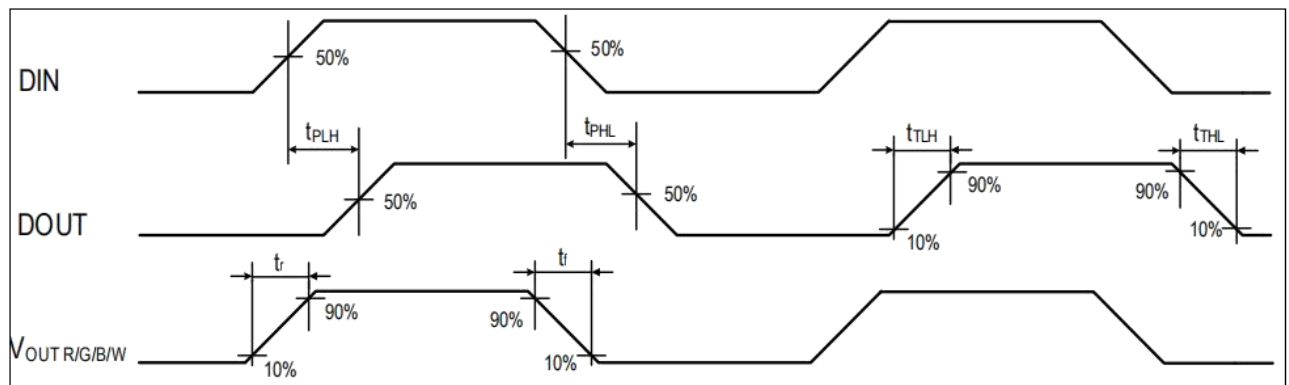

内置 LED 参数/Built-in LED parameters:

发光颜色	主波长 (nm) 色温 (K)	发光强度 (mcd)	工作电流 (mA)	工作电压 (V)
R	620-625	500-600	20	2.0-2.2
G	520-525	2000-2400	20	3.0-3.3
B	465-470	240-300	20	3.0-3.3
W	8000-10000	3000-5000	20	3.0-3.3

数据通信协议/Data Communication Protocol:

1、编码描述：

协议采用的是单极性归零码，每一个码元都必须有低电平。本协议的每个码元起始为高电平，高电平时间宽度决定“0”码或者“1”码。/CODING DESCRIPTION: the Protocol is a unipolar zeroing code, each code element must have a low level. Each code element of this agreement starts at a high level. The high level time width determines the "0" code or the "1" code.

输入码型:

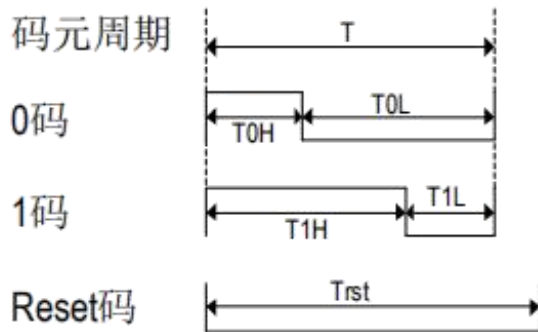

归零码数据通信协议图/Protocol Diagram of return to zero code data communication

符号	参数	最小值	典型值	最大值	单位
T	码元周期	1200	-	-	ns
T0H	0 码, 高电平时间	200	300	400	ns
T0L	0 码, 低电平时间	800	900	-	ns
T1H	1 码, 高电平时间	700	900	1000	ns
T1L	1 码, 低电平时间	200	300	-	ns
Trst	Reset 码, 低电平时间	200	-	-	us

注：(1)、写程序时，码元周期最低要求为 1.2us/When writing a program, the Minimum Code Period is 1.2 us;
 (2)、0 码、1 码的高电平时间需按照上表的规定范围，0 码、1 码的低电平时间要求小于 20us/0 Yards, 1 yards of high-level time in accordance with the table above range, 0 yards, 1 yards of low-level time requirements less than 20 US; 2. Protocol data format ;

2、协议数据格式 /Protocol data format

Trst+第一颗芯片 32bits 数据+第二颗芯片 32bits 数据+.....+第 N 颗芯片 32bits 数据+Trst /Trst first chip 32bit data Second chip 32bit data... 32bits data Trst for the NTH chip

32bits 灰度数据结构：高位在前，按照 RGB 的顺序发送 /32bits gray data structure: high bit first, sent in RGB order

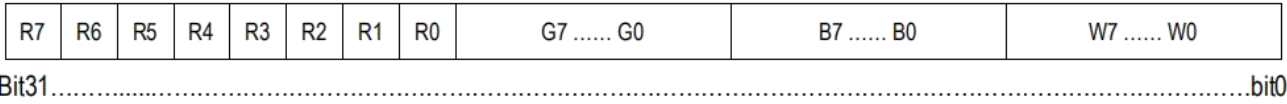

3、系统拓扑图/System topology



4、各芯片输入数据流： /Each chip input data stream



恒流曲线/Constant-current curve:

5050内封IC -01W 内置 IC恒流特性优异，通道间甚至芯片间的电流差异极小。 /The 5050 IC-01W BUILT-IN IC has excellent constant current characteristics, and the current difference between channels and chips is very small.

(1): 通道间的最大电流误差小于±1.5%，而芯片间的最大电流误差小于±3%。 The maximum current error between channels is less than ± 1.5% , and the maximum current error between chips is less than ± 3%.

(2): 当负载端电压发生变化时，输出电流不受影响，如下图所示 /When the voltage at the load end changes, the output current is not affected, as shown in the figure below:

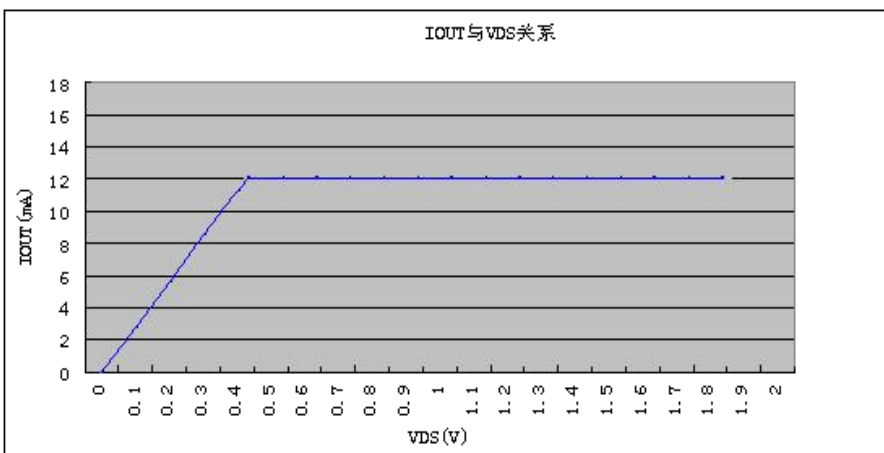

应用线路图/Application Route Diagram:

电源电压 5V (如下图示) /Power supply voltage 5V(as shown)

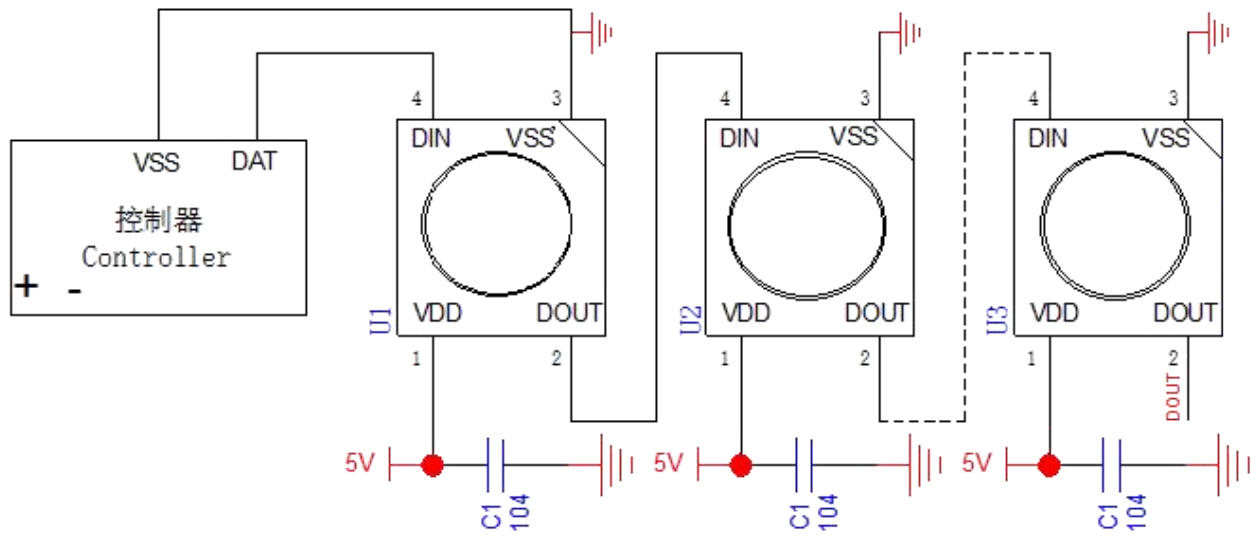

产品应用中驱控灯珠级联数量及控制器参数配置、驱动电源品质均有较大差异，故请在批量使用产品前，客户方务必自行验证产品兼容性，威能不承诺满足客户所有应用需求。/In the application of the product, there are big differences in the number of the cascade of the driving lights, the configuration of the controller parameters and the quality of the driving power, power is not committed to meeting all customer application requirements.

典型特性曲线

Typical Characteristics Curves

白光特性曲线:

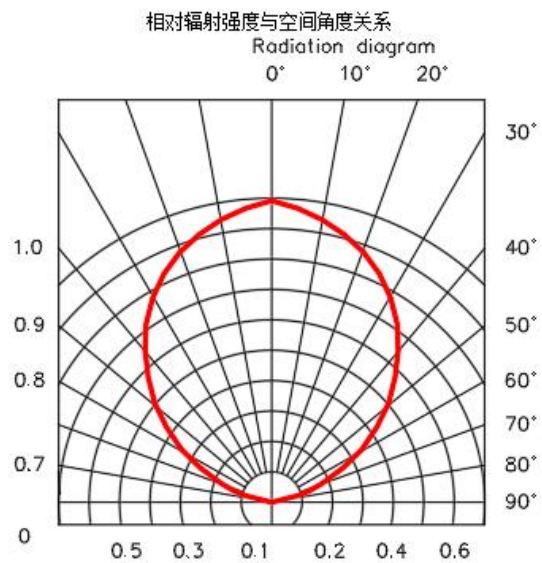
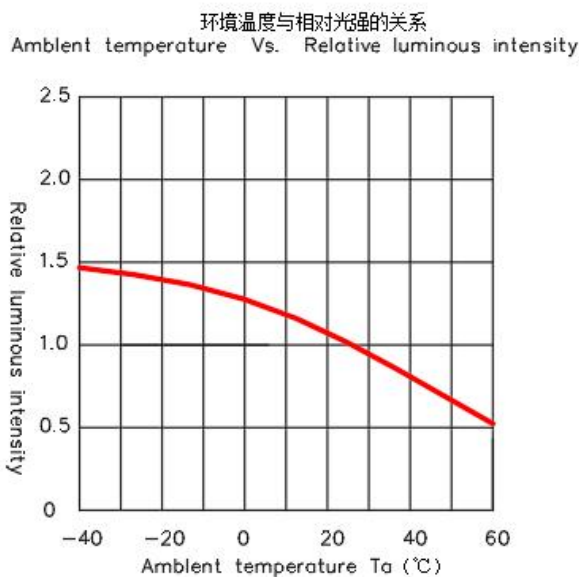
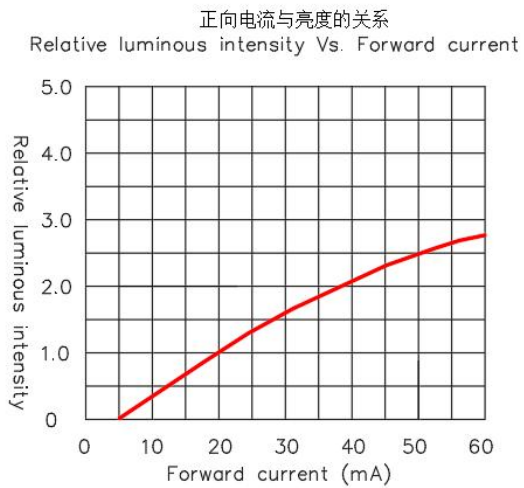
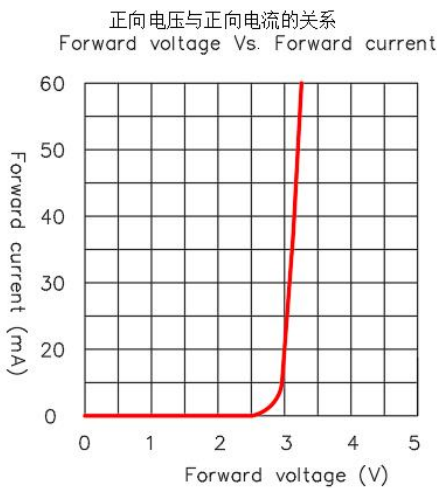
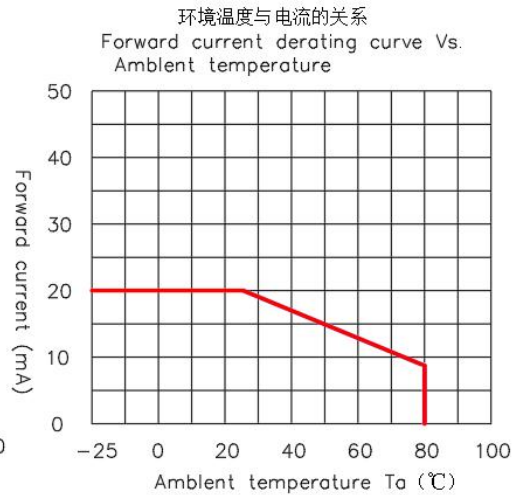
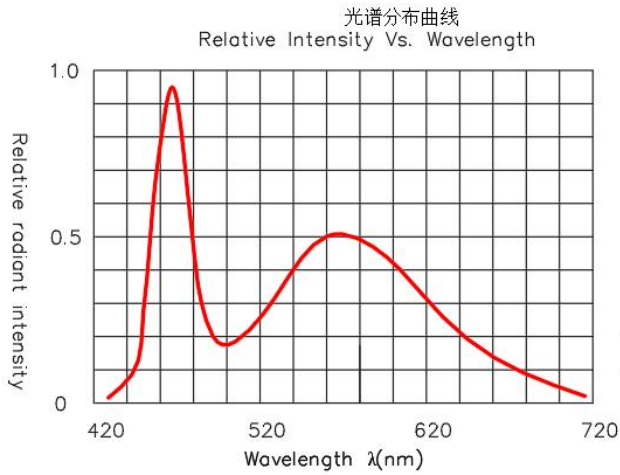

RGB 特性曲线:

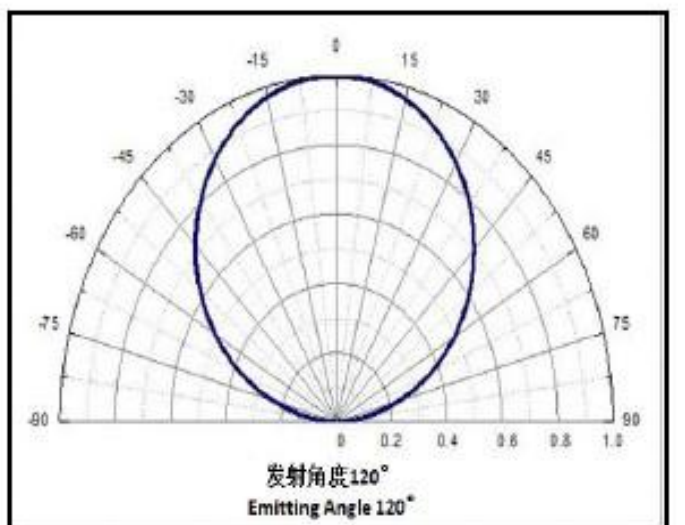
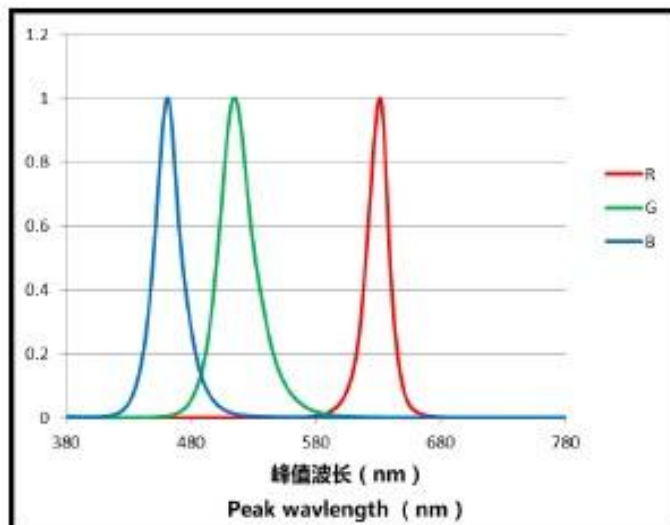
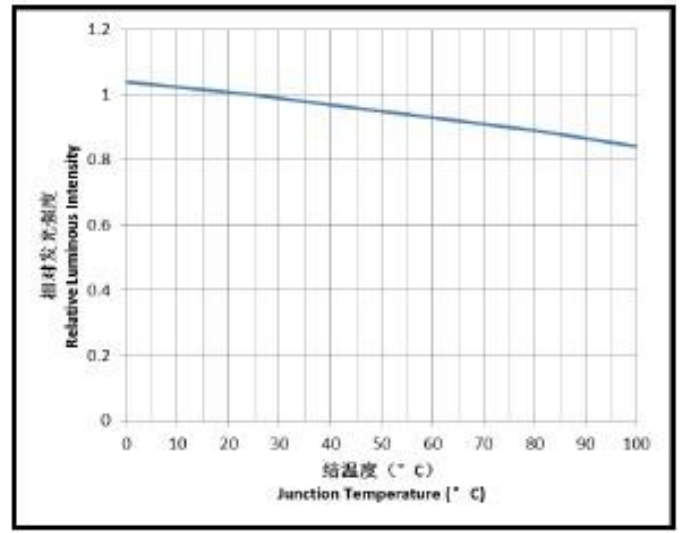
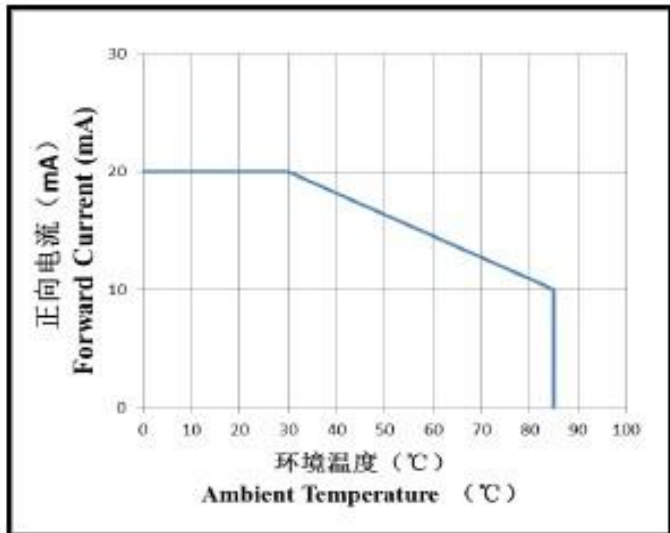
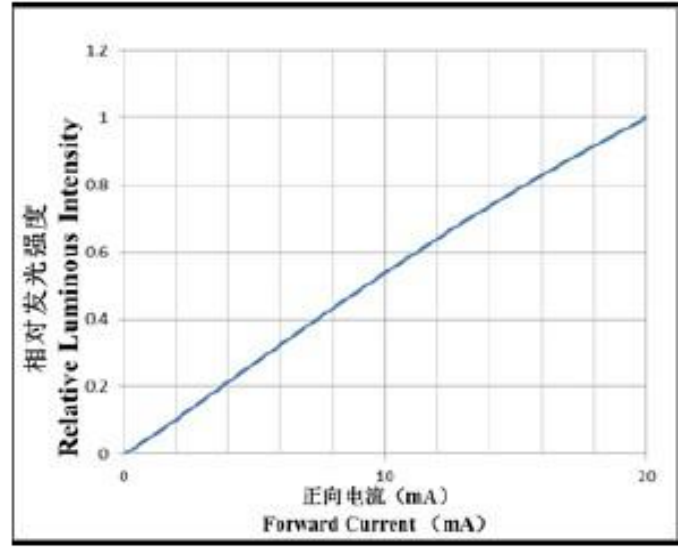
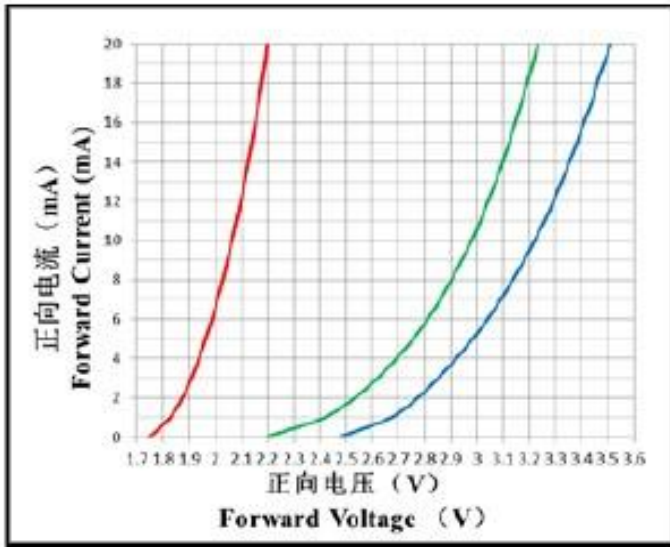

可靠性试验

Reliability Test Items And Conditions

*可靠性实验项目 Reliability Test Project

描述 Description	项目 Item	测试标准 Test criterion	测试条件 Test condition	测试时间 Testtime	数量 Qty	失效数量 Fail qty
寿命测试 Life test	常温寿命测试 Life test(room temperature)	JIS7021:B4	Ta=25°C±5°C, IF=20mA	1000Hrs	22	0
环境测试 Ambience test	高温存储 High temperature store	JIS7021:B10 MIL-STD-202:210A MIL-STD-750:2031	Ta=85°C±5°C	1000Hrs	22	0
	低温存储 Low temperature store	JIS7021:B12	Ta=-35°C±5°C	1000Hrs	22	0
	高温高湿测试 High temperature/ humidity test	JIS7021:B11 MIL-STD-202:103D	Ta=85°C±5°C RH=85%	1000Hrs	22	0
	冷热冲击测试 Cold / Heat strike test	JIS7021::B4 MIL-STD-202:107D MIL-STD-750:1026	30min -10°C±5°C←→100°C± 5°C 5min 5min	50Cycles	22	0
	冷热循环测试 Cold and heat cycle test	JIS7021:A3 MIL-STD-202:107D MIL-STD-705:105E	5min 5min 5min -35°C~25°C~85°C~ -35°C 30min 5min 30min 5min	50Cycles	22	0

*判断标准 Judging criterion:

项目 Item	符号 Symbol	实验条件 Experiment condition	判断标准 Criteria	
			Min.	Max.
Forward Voltage 正向电压	VF	IF=20mA	----	Initial Datex1.1
Reverse Current 反向电流	IR	VR=5V	----	5 μ A
Luminous Intensity 发光强度	IV	IF=20mA	Initial Datex0.7	----

外形尺寸

Outline Dimension

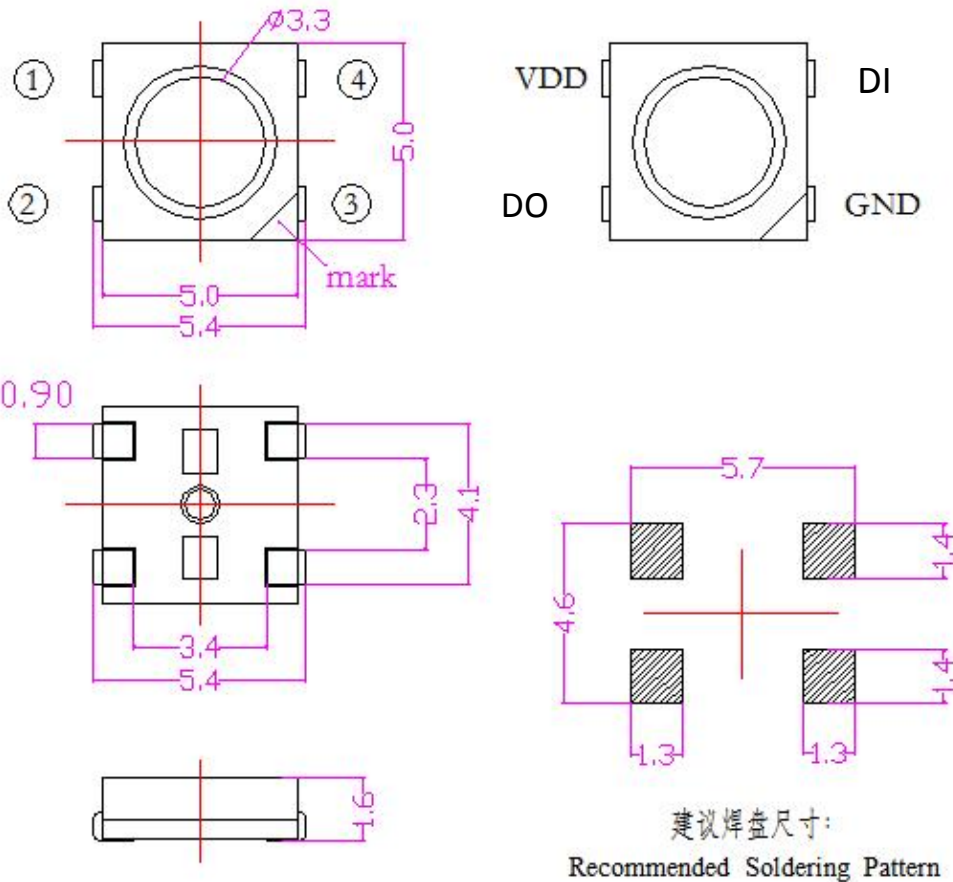

- 备注: 1. 以上尺寸单位均为 mm
Remarks: All dimensions are in millimeters.
2. 未特别标注公差尺寸公差均为 ± 0.25 mm
Tolerance is ± 0.25 mm unless otherwise noted

引脚电路图及引脚功能:

序号 Serial number	符号 Symbol	功能描述 Function description
1	VCC/VDD	内部 IC 电源正及 RGB、白光正
2	DO/OUT	显示数据级联输出 (800K)
3	GND/VSS	信号地及电源地
4	DIN	显示数据输入 (800K)

包装 (1)

Packaging (1)

载带与圆盘尺寸 Belt and disk dimensions

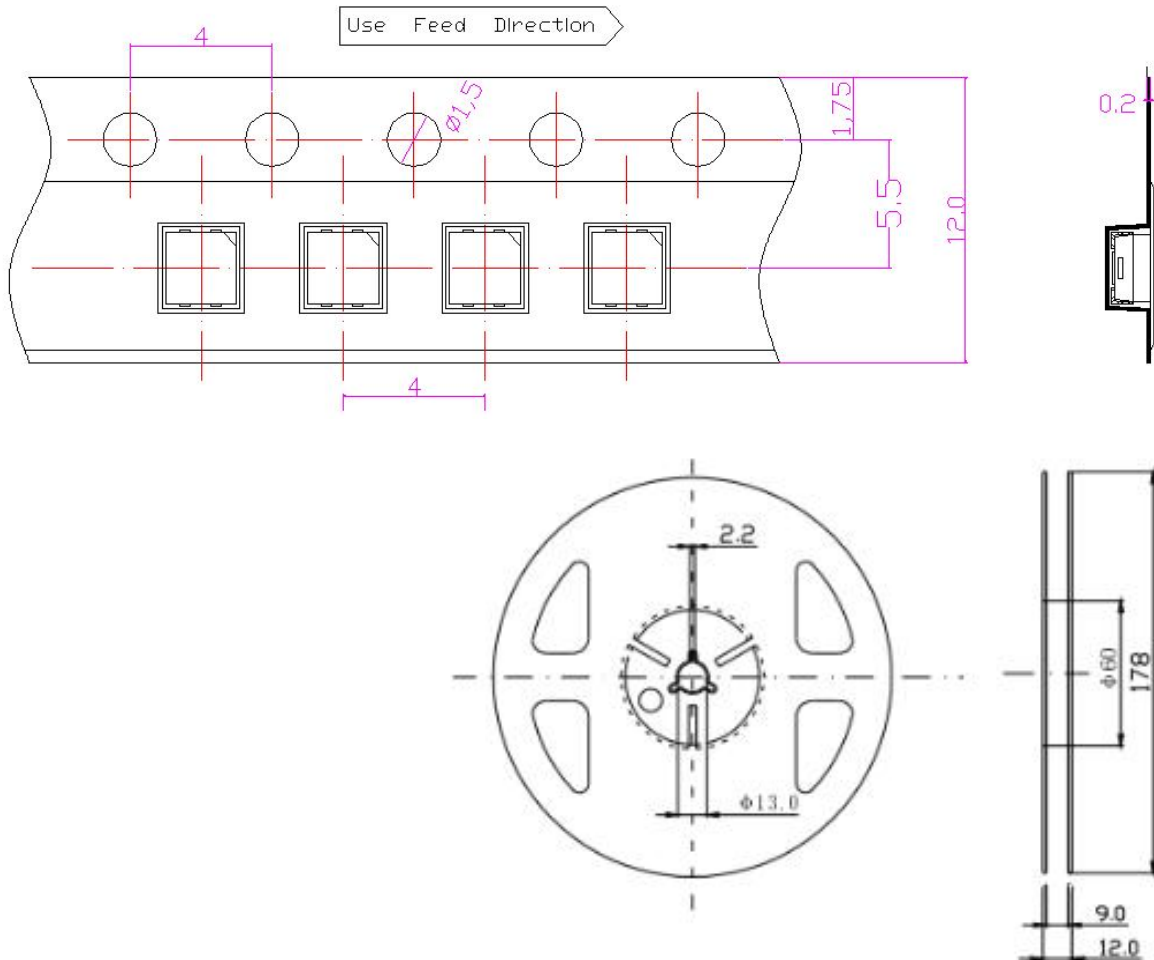

备注： 1. 以上尺寸单位均为 mm

Remarks: All dimensions are in millimeters.

2. 未特别标注公差尺寸公差均为 $\pm 0.25\text{mm}$

Tolerance is $\pm 0.25\text{mm}$ unless otherwise noted

◆ 圆盘及载带卷出方向及空穴规格 Disk and carrier belt direction of roll and hole dimensions

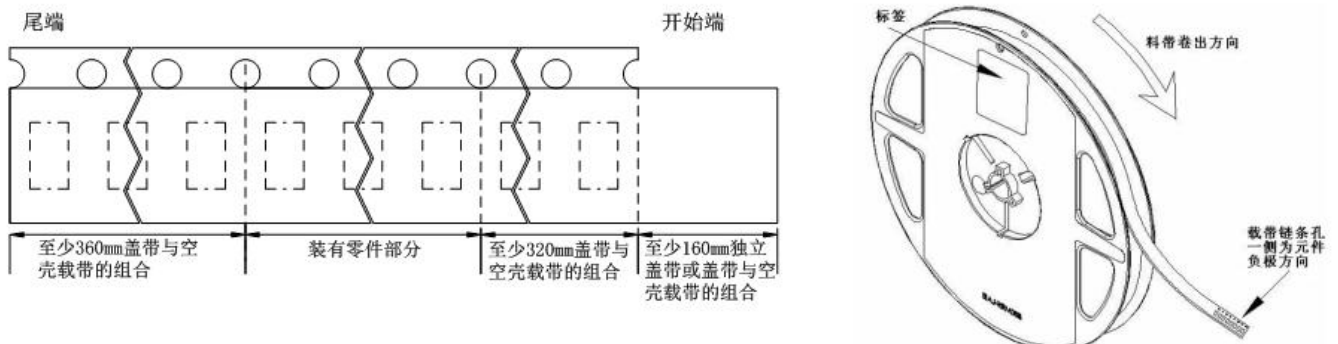

包装 (2)

Packaging (2)

◇ 防潮防静电包装 Moisture Proof and Anti-Electrostatic Foil Bag

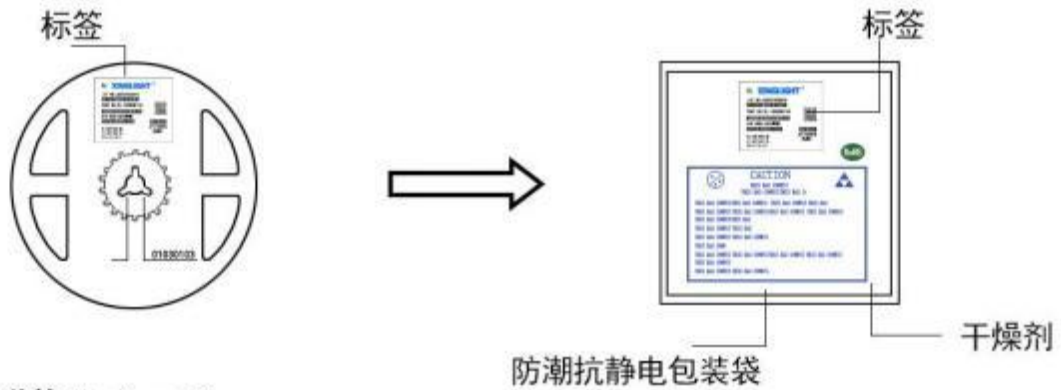

◇ 外包装箱 Cardboard Box

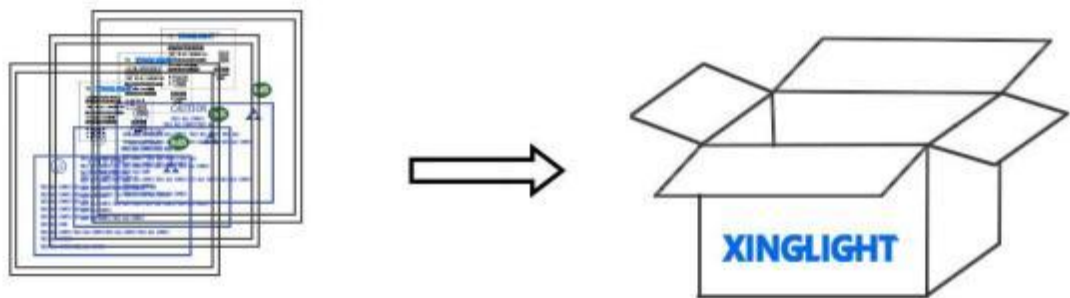

Capacity 5 or 10 reels per box (内箱容量: 50或100卷)

◇ 标签说明: Label Explanation

- LOT NO: 批次信息
- PART NO: 产品型号
- BIN CODE: 产品名称
- WL: 波长范围
- IV: 光强范围
- VF: 电压范围



焊接指导 (1)

Guideline for Soldering (I)

1. 使用烙铁人手焊接

Hand Soldering

只建议在修理和重工的情况下使用手工焊接；推荐使用功率低于 30 W 的烙铁，焊接时烙铁的温度必须保持在 300℃ 以下，且每个电极只能进行一次焊接，每次焊接的持续时间不得超过 3 秒。

人手焊接过程中的不慎操作易引起 LED 产品的损坏，应当小心谨慎。

Manual welding is recommended only for repair and heavy industry situations. A soldering iron of less than 30W is recommended to be used in Hand Soldering. Please keep the temperature of the soldering iron under 300°C while soldering. Each terminal of the LED is to go for less than 3 second and for one time only.

Be careful because the damage of the product is often started at the time of the hand soldering.

2. 回流焊接： 推荐使用以下无铅回流焊接温度图进行。

Reflow Soldering: Use the conditions shown in the under Figure of Pb -Free Reflow Soldering.

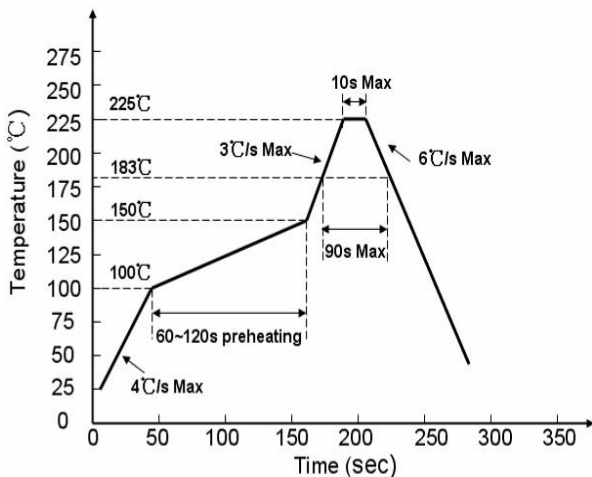

有铅制程 Lead process

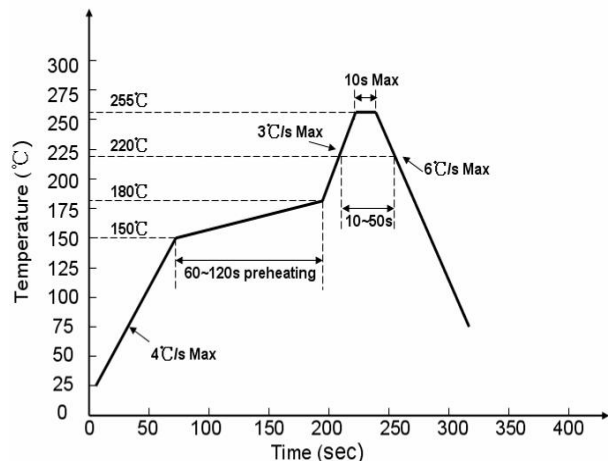

无铅制程 lead free

回流焊接最多只能进行两次。

Reflow soldering should not be done more than two times.

在回流焊接升温过程中，请不要对 LED 施加任何压力。

Stress on the LEDs should be avoided during heating in soldering process.

在焊接完成后，待产品温度下降到室温之后，再进行其他处理。

After soldering, do not deal with the product before its temperature drop down to room temperature.

焊接指导 (2)

Guideline for Soldering (2)

3. 清洗:

Cleaning

在焊接后推荐使用酒精进行清洗，在温度不高于 30°C 的条件下持续 3 分钟，不高于 50°C 的条件下持续 30 秒。

使用其他类似溶剂清洗前，请先确认使用的溶剂不会对 LED 的封装和环氧树脂部分造成损伤。超声波清洗也是有效的方法，一般最大功率不应超过 300W，否则可能对 LED 造成损伤。请根据具体的情况预先测试清洗条件是否会对 LED 造成损伤。

It is recommended that alcohol be used as a solvent for cleaning after soldering. Cleaning is to go under 30°C for 3 minutes or 50°C for 30 seconds. When using other solvents, it should be confirmed beforehand whether the solvents will dissolve the package and the resin or not.

Ultrasonic cleaning is also an effective way for cleaning. But the influence of Ultrasonic cleaning on LED depends on factors such as ultrasonic power. Generally, the ultrasonic power should not be higher than 300W. Before cleaning, a pretest should be done to confirm whether any damage to LEDs will occur.

*** 注意：** 此一般指导原则并不适用于所有 PCB 设计和焊接设备的配置。具体工艺受到诸多因素的影响，请根据特定的 PCB 设计和焊接设备来确定焊接方案。

*** Note:** This general guideline may not apply to all PCB designs and configurations of all soldering equipment. The technics in practise is influenced by many factors, it should be specialized base on the PCB designs and configurations of the soldering equipment..

使用注意事项 (1)

Precautions (1)

1. 贮存:

Storage

- 本产品使用密封防潮抗静电袋包装，并附有干燥剂，未开封的产品有一年的保存时间。

Moisture proof and anti-electrostatic package with moisture absorbent material is used, to keep moisture to a minimum.

- 开封前，产品须存放在温度不高于 30℃，湿度不高于 60%RH 的环境中。

Before opening the package, the product should be kept at 30℃ or less and umidity less than 60% RH, and be used within a year.

- 开封后，产品须存放在温度不高于 30℃，湿度不高于 10%RH 的环境中，且应该在 168 小时（7 天）内使用完。建议工作环境为温度不高于 30℃，湿度不高于 60%RH。

After opening the package, the product should be stored at 30℃ or less and humidity less than 10%RH, and be soldered within 168 hours (7 days). It is recommended that the product be operated at the workshop condition of 30℃ or less and humidity less than 60%RH.

- 对于尚未焊接的 LED，如果吸湿剂或包装失效，或者产品没有符合以上有效存储条件，烘焙可以起到一定的性能恢复效果。烘焙条件：60±5) °C，持续24 小时。

If the moisture absorbent material has fade away or the LEDs have exceeded the storage time, baking treatment should be performed based on the following condition: (60±5)°C for 24 hours.

2. 静电:

Static Electricity

静电和电涌会导致产品特性发生改变，例如正向电压降低等，如果情况严重甚至会损毁产品。所以在使用时必须采取有效的防静电措施。所有相关的设备和机器都应该正确接地，同时必须采取其他防止静电和电涌的措施。使用防静电手环，防静电垫子，防静电工作服、工作鞋、手套，防静电容器，都是有效的防止静电和电涌的措施。

Static electricity or surge voltage damages the LEDs. Damaged LEDs will show some unusual characteristic such as the forward voltage becomes lower, or the LEDs do not light at the low current. even not light.

All devices, equipment and machinery must be properly grounded. At the same time, it is recommended that wrist bands or anti-electrostatic gloves, anti-electrostatic containers be used when dealing with the LEDs.

使用注意事项 (2)

Precautions (2)

3. 设计建议:

Design Consideration

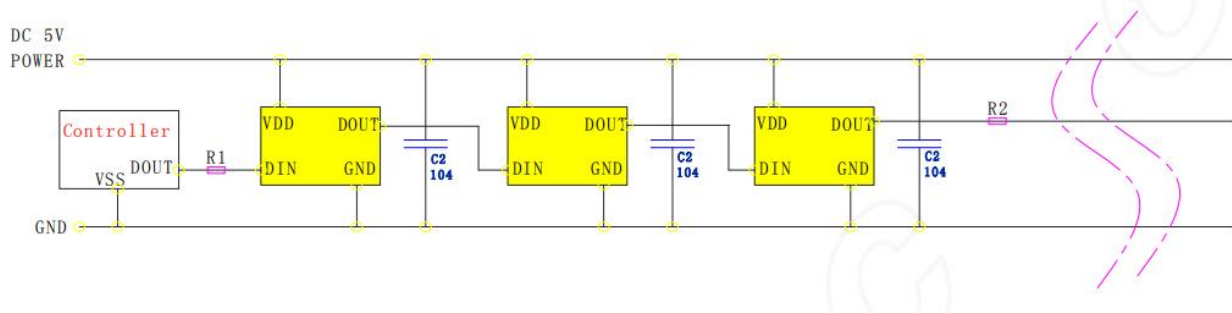

在实际应用电路中,为防止产品在测试时带电插拔产生的瞬间高压损伤 IC 内部电源及 信号输入输出脚,应在信号输入及输出端串接保护电阻。此外,为了使各 IC 芯片间更 稳定工作,各灯珠间的退偶电容则必不可少;

1. 产品两端所并的退偶电容一般不建议省略;
2. 产品的信号输入及输出端必需串接保护电阻 R1/R2, 因线材及传输距离不同, 在信号线两端串接的保护电阻会略有不同; R1/R2 的大小取决于级联灯珠的数量, 级联数量越多, 则 R1/R2 越小, 灯珠间传输距离长, 一般建议在 20-2K Ω 之间取值, 建议通常建议取值 在 500 欧左右; 以实际使用情况定; R2 可接地。

In practical application circuits, To prevent instantaneous high voltage generated by live plugging during product testing Damage to IC internal power supply and signal input/output pins Protective resistors should be connected in series at the signal input and output terminals .In addition, in order to ensure more stable operation between IC chips The decoupling capacitance between each lamp bead is essential:

- 1、 It is generally not recommended to omit the decoupling capacitors connected at both ends of the pr... ;
- 2、 The signal input and output terminals of the product must be connected in series with protective r...; Due to differences in wire material and transmission distance; The size of r1/r2 depends on the number of cascaded lamp beads , The more cascades, the smaller r1/r2 ; Long transmission distance between lamp beads , Generally recommended between 20-2k ω Value between , The recommended value is usually around 500 euros; Based on actual usage; R2 can be grounded .

使用注意事项 (3)

Precautions (3)

4. 其他事项:

Others

直接用手拿取产品不但会污染封装树脂表面,也可能由于静电等因素导致产品性能的改变。过度的压力也可能直接影响封装内部的管芯和金线,因此请勿对产品施加过度压力,特别当产品处于高温状态下,例如在回流焊接过程中。

When handling the product, touching the encapsulant with bare hands will not only contaminate its surface, but also affect on its optical characteristics. Excessive force to the encapsulant might result in catastrophic failure of the LEDs due to die breakage or wire deformation. For this reason, please do not put excessive stress on LEDs, especially when the LEDs are heated such as during Reflow Soldering.

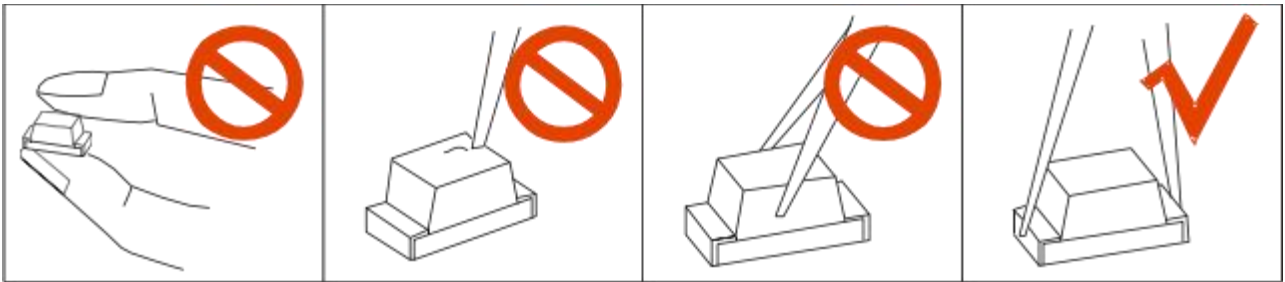

LED 的环氧树脂封装部分相当脆弱,请勿用坚硬、尖锐的物体刮、擦封装树脂部分。在用镊子夹取的时候也应当小心注意。

The epoxy resin of encapsulant is fragile, so please avoid scratch or friction over the epoxy resin surface.

While handling the product with tweezers, do not hold by the epoxy resin, be careful.

5. 眼睛保护忠告:

Safety Advice For Human Eyes

LED 发光时,请勿直视发光光源,特别是对于一些光强较高的 LED,强光可能伤害你的眼睛。

Viewing direct to the light emitting center of the LEDs, especially those of great Luminous Intensity, will cause great hazard to human eyes. Please be careful.

X-ON Electronics

Largest Supplier of Electrical and Electronic Components

Click to view similar products for [Standard LEDs - SMD category](#):

Click to view products by [XINGLIGHT manufacturer](#):

Other Similar products are found below :

[LTST-C190KYKT](#) [LTST-C19GD2WT](#) [LTW-170ZDC](#) [LTW-M140SZS40](#) [LTW-M140ZVS](#) [598-8110-100F](#) [598-8610-202F](#) [91-21SUBCS400-A6TR7](#) [AAAF5060QBFSEEZGS](#) [APT1608QGW](#) [99-213/R6C-AR2T1B/2C](#) [SML-LX0606SISUGC/A](#) [SML-LXR851SIUPGUBC](#) [LT1ED53A](#) [APFA3010SURKCGKQBDC](#) [APHK1608VGCA](#) [APT2012QGW](#) [LTST-008BGEW](#) [LTW-010DCG](#) [LTW-21TS5](#) [LTW-220DS5](#) [598-8330-117F](#) [65-21SYGC/S530-E3/TR8](#) [CMDA20AYAA7D1S](#) [95-21SURCS530-A3TR10](#) [598-8070-100F](#) [598-8140-100F](#) [598-8610-200F](#) [SML-LXR851SGSIC-TR](#) [SML-512PWT86A](#) [SMF-2432GYC-TR](#) [EASV3015RGYA0](#) [95-21UYC-S530-A5-TR7](#) [LTST-C190KFKT-5A](#) [LTST-C194TBKT-5A](#) [CLX6E-FKC-CH1M1D1BB7C3D3](#) [SML-LXL0805USBC-TR](#) [SML-LX2835SYSUGCTR](#) [LTW-M670ZVS-M5](#) [APA2106ZGC/G](#) [CLMXB-FKA-CbcfghjnpACBB79463](#) [KPTD-2012LVVBC-D](#) [VFA1101W-5AY3B2-TR](#) [LCB P473-P2R2-3J7L-1-Z](#) [91-21VGC/S556/S68/TR10/S370](#) [LW A67C-S2U1-FK0KM0](#) [LW A673-P1S1-FK0PM0](#) [BL-HE1G033B-TRB](#) [5988B90107F](#) [EL-19-21SURC/S530-A6](#)