

6048血氧接收 血氧感测二极管

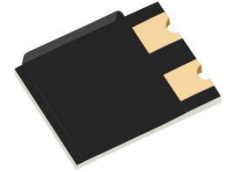

特点 (Characteristic) :

- * 外观尺寸 (L/W/H) :6.0*4.8*1.1mm
Outline Dimensions (L / w / h): 6.0*4.8*1.1 mm
- * 发光颜色及胶体:红外接收/黑色胶体
Luminous color and colloid: Infrared reception/black colloid
- * 环保工艺符合ROHS标准
Environmental protection products Complied With RoHS Directive
- * EIA规范标准包装
EIA standard packaging
- * 适用于SMT贴片自动化生产
Suitable for SMT automatic mounter
- * 适用于回流焊制程
Suitable for reflow soldering production
- * 与SMT自动设备兼容
Compatible With SMT Automatic Equipment

应用领域 (Product application) :

- * 安防监控
Security monitoring
- * 虹膜识别
Iris Recognition
- * 体温检测感应路
Temperature detection sensing circuit
- * 遥控感应
Remote sensing
- * 血氧仪
Oximeter
- * 红外扫描
Infrared scanning



目录

Catalogue

电性参数	
Electrical Characteristics.....	3
典型特性曲线	
Typical Characteristic Curves.....	6
可靠性实验	
Reliability Test Items And Conditions.....	7
外形尺寸	
Outline Dimensions.....	9
包装	
Packaging.....	10
焊接指导	
Guideline for Soldering.....	12
使用注意事项	
Precautions.....	14

电性参数

Electrical Characteristics

极限参数（温度=25℃）：
Absolute Maximum Ratings

参数名称 Parameter	符号 Symbol	数值 Rating	单位 Units
消耗功率 Power consumption	Pd	130	mW
反向电压 Reverse voltage	VR	15	V
工作环境温度 Operating ambient temperature	Topr	-30°C ~ +85°C	
存储环境温度 Storage ambient temperature	Tstg	-40°C ~ +90°C	
焊接条件 Welding conditions	Tsol	回流焊Reflow soldering : 260°C , 10s 手动焊Manual welding : 300°C , 3s	

Limit parameters (Temperature=25°C):

* 注： 脉冲宽度 $\leq 0.1\text{ms}$ ， 占空比 $\leq 1/10$

* Note: Pulse width $\leq 0.1\text{ms}$, Duty $\leq 1/10$

光电参数 (温度=25°C) :

Electro-Optical Characteristics (Temperature=25°C):

Parameter 参数	Symbol 符号	Min. 最小值	Typ. 典型值	Max. 最大值	Unit 单位	Test Condition 试验条件
光谱带宽范围 Spectral bandwidth range	$\lambda_{0.5}$	400	---	1100	nm	---
峰值敏感波长 Peak sensitive wavelength	λ_p		940		nm	---
开路电压 Open circuit voltage	Voc	---	0.45	---	V	Ee=5mW/cm ² $\lambda_p=940\text{nm}$
敏感半角值 Sensitive half angle value	ϕ	---	60	---	°	Ee=1mW/cm ² $\lambda_p=940\text{nm}$
光电流 Photocurrent	I _p	35	40	45	μA	Ee=1mW/cm ² $\lambda_p=940\text{nm}, VR=5V$
光电流 Photocurrent	I _p	60	65	70	μA	Ee=1mW/cm ² $\lambda_p=660\text{nm}, VR=5V$
光电流 Photocurrent	I _p	25	30	35	μA	Ee=1mW/cm ² $\lambda_p=890\text{nm}, VR=5V$
反向暗电流 Reverse dark current	I _D	---	---	30	nA	Ee=0mW/cm ² VR=10V
反向击穿电压 Reverse breakdown voltage	VBR	32	170	---	V	Ee=0mW/cm ² IR=100μA
上升下降时间 Rise and fall time	Tr , Tf	---	2.5	---	μS	---
结电容 Junction capacitance	TJ	---	27	---	pF	Ee=0mW/cm ² VR=5V, F=1 MHz

亮度分档:

Brightness grading:

代码 Code	最小值 Min	最大值 Max	单位 unit	测试条件 Test conditions
L05	12	14	mcd	IF=20mA

电压分档:

Voltage grading

代码 Code	最小值 Min	最大值 Max	单位 unit	测试条件 Test conditions
F03	0.6	0.8	V	IF=20mA

典型特性曲线

Typical Characteristics Curves

图一：光谱敏感度曲线

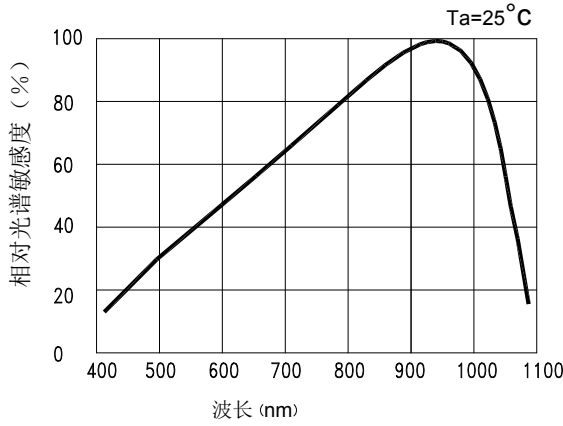

图二：暗电流VS反向电压曲线

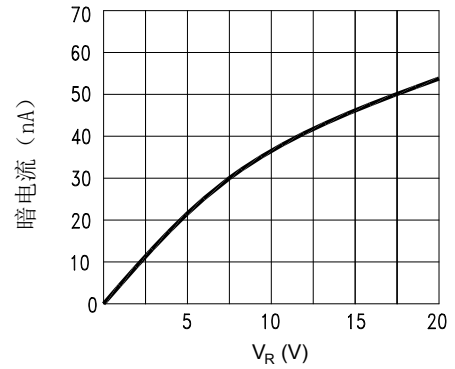

图三：耗散功率VS环境温度曲线

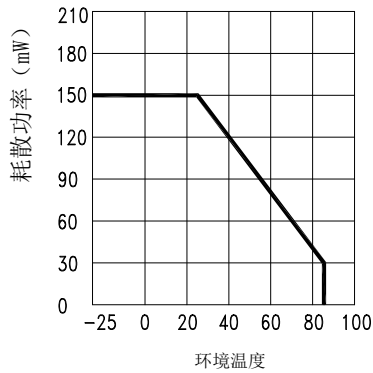

图四：敏感度分布曲线1

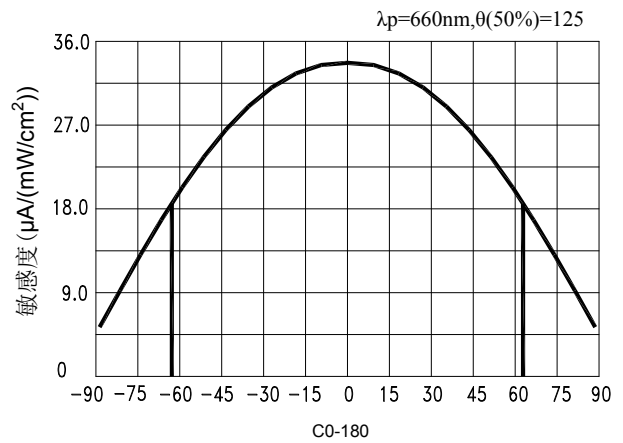

图五：敏感度分布曲线2

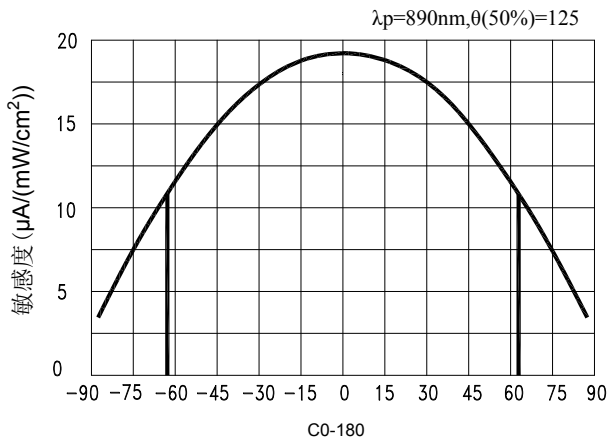

图六：敏感度分布曲线3

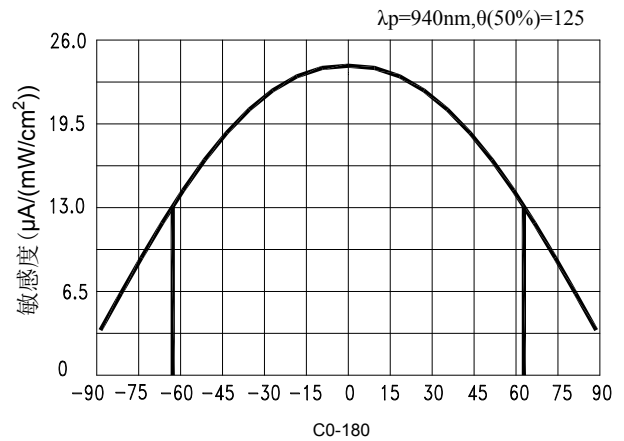

可靠性试验

Reliability Test Items And Conditions

测试项目 Test items	测试条件 Test conditions	测试次数 Number of tests	参考标准 Reference Standards	失效判定标准 Failure determination standard	失效LED数量 (PCS) Number of failure LEDs (PCS)
防潮等级 Moisture proof grade	1. 回流焊最高温度=260℃, 10秒, 2次回流焊; 1. The maximum temperature of reflow soldering=260 °C, 10 seconds, two reflow soldering; 2. 回流焊之前存储条件: 30℃, 相对湿度=70%, 168H; 2. Storage conditions before reflow soldering: 30 °C, relative humidity=70%, 168H;	-	JEITA ED-4701 300 301	# 1	0/22
焊接信赖性 (无铅回流焊) Welding reliability (Lead free reflow soldering)	回流焊最高温度=245±5℃, 5秒 (无铅回流焊) Maximum reflow temperature=245 ± 5 °C, 5 seconds (lead-free reflow)	-	JEITA ED-4701 303 303A	# 2	0/22
冷热循环 thermal cycling	-40℃ 30分钟~25℃ 5分钟~100℃ 30分钟~25℃ 5分钟	300个循环 300 loop	JESD22-A104	# 1	0/22
冷热冲击 Thermal Shock	-35℃ 15分钟 转换时间3分钟 85℃ 15分钟 -35 °C for 15 minutes Conversion time: 3 minutes 85 °C for 15 minutes	300个循环 300 loop	JESD22-A106	# 1	0/22
高温存储 High temperature storage	Ta=100℃	1000 小时 1000 hours	JESD22-A103	# 1	0/22
低温存储 Low temperature storage	Ta=-40℃	1000 小时 1000 hours	JESD22-A119	# 1	0/22
常温老化 Normal temperature aging	Ta=25℃ IF=20mA	1000小时 1000 hours	JESD22-A108	# 1	0/22

失效判定标准 Judgement standard fail

标准 # standard	项目 project	测试条件 Test conditions	失效标准 Failure criteria
# 1	正向电压(V _F) Forward voltage (VF)	I _F =20mA	>U.S.L*1.1
	辐射强度 (mW/sr) Radiation intensity (mW/sr)	I _F =20mA	<L.S.L*0.7
	反向电流(I _R) Reverse current (IR)	V _R =5V	>U.S.L*2.0
# 2	焊接可靠性 Welding reliability	/	锡膏覆盖焊盘比例小于95% The proportion of solder paste covering pads is less than 95%

备注(Note):

U.S.L: 规格上限; L.S.L 规格下限

数据表格中所示的技术信息仅限于典型特征值和电路实例引用的产品, 它既不构成工业特性的保证, 也不构成任何许可的授权

The technical information shown in the data table is limited to products referenced by typical eigenvalues and circuit instances and does not constitute a guarantee of industrial characteristics nor does it constitute an authorization of any license

外形尺寸

Outline Dimension

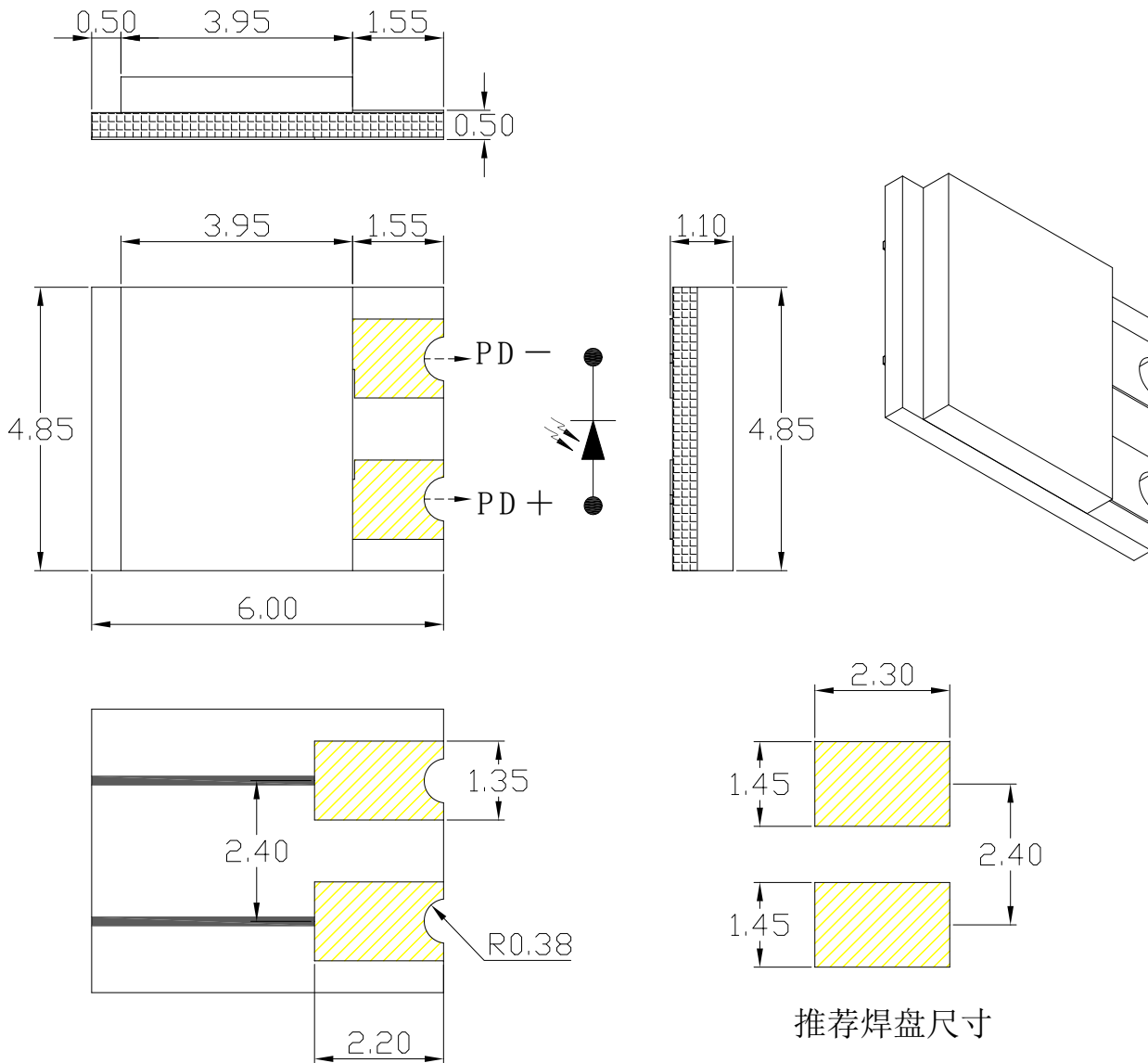

註Notes:

1. 所有尺寸都以毫米为单位
(All dimensions are in millimeters) .
2. 公差为±0.20 毫米除非另有说明
(Tolerance is ±0.20mm unless otherwise noted) .

包装 (1)

Packaging (1)

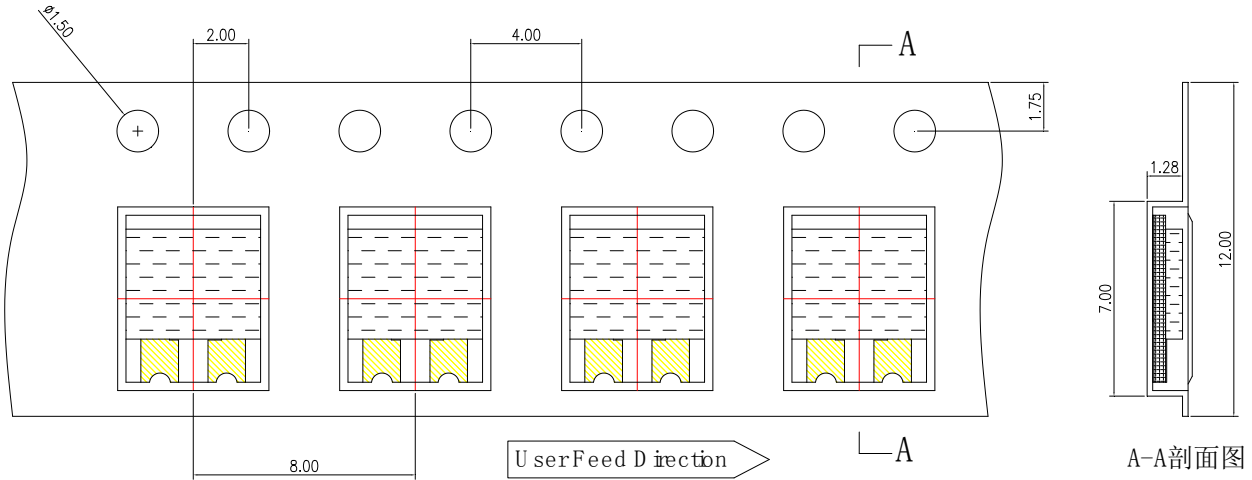

卷筒尺寸:

Reel Dimensions:

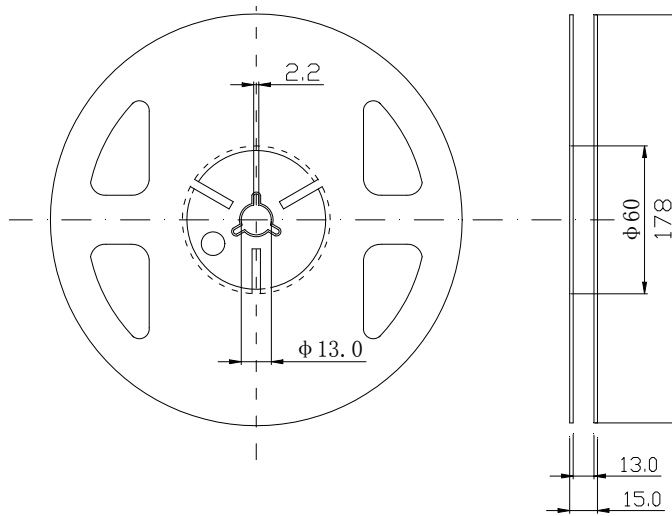

注：1。所有尺寸单位均为毫米；

Notes: 1. All dimensions are in millimeters ;

2, 除非另有说明, 公差为±0.10 mm。

Tolerance is ± 0.10 mm unless otherwise noted.

包装 (2)

Packaging (2)

◇ 防潮防静电包装 Moisture Proof and Anti-Electrostatic Foil Bag

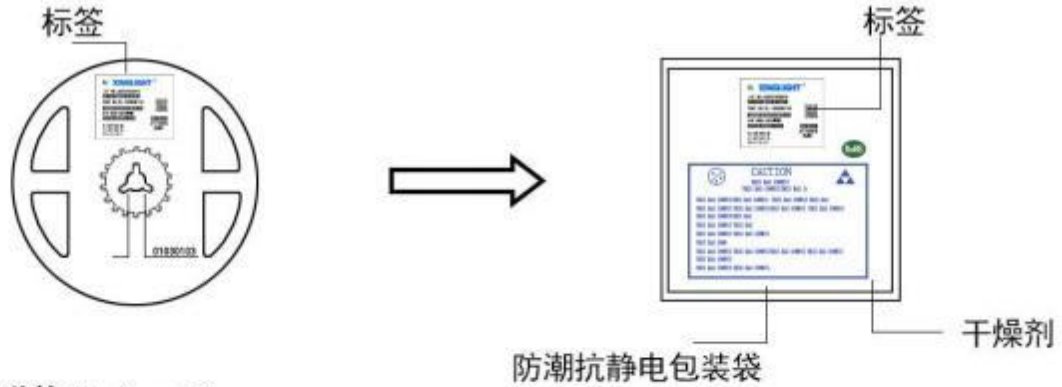

◇ 外包装箱 Cardboard Box



Capacity 5 or 10 reels per box (内箱容量: 50或100卷)

◇ 标签说明: Label Explanation

- LOT NO: 批次信息
- PART NO: 产品型号
- BIN CODE: 产品名称
- WL: 波长范围
- IV: 光强范围
- VF: 电压范围



焊接指导（1）

Guideline for Soldering (1)

1. 使用烙铁人手焊接

Hand Soldering

推荐使用功率低于 20W 的烙铁，焊接时烙铁的温度必须保持在 300℃ 以下，且每个电极只能进行一次焊接，每次焊接的持续时间不得超过 3 秒。

人手焊接过程中的不慎操作易引起 LED 产品的损坏，应当小心谨慎。

A soldering iron of less than 20W is recommended to be used in Hand Soldering. Please keep the temperature of the soldering iron under 300℃ while soldering. Each terminal of the LED is to go for less than 3 second and for one time only.

Be careful because the damage of the product is often started at the time of the hand soldering.

2. 回流焊接： 推荐使用以下无铅回流焊接温度图进行。

Reflow Soldering: Use the conditions shown in the under Figure of Pb-Free Reflow Soldering.

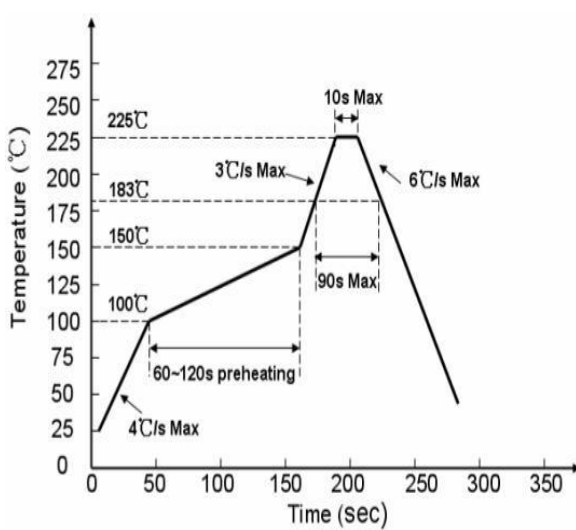

用于铅焊料

For Lead Solder

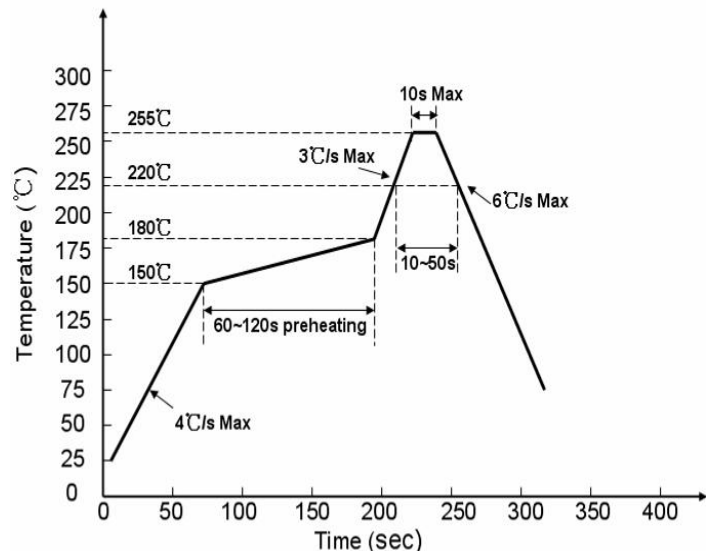

无铅焊料

For Lead Free Solder

- 回流焊接最多只能进行两次。

Reflow soldering should not be done more than two times.

- 在回流焊接升温过程中，请不要对 LED 施加任何压力。

Stress on the LEDs should be avoided during heating in soldering process.

- 在焊接完成后，待产品温度下降到室温之后，再进行其他处理。

After soldering, do not deal with the product before its temperature drop down to room temperature.

焊接指导 (2)

Guideline for Soldering (2)

3. 清洗:

Cleaning

在焊接后推荐使用酒精进行清洗，在温度不高于 30°C 的条件下持续 3 分钟，不高于 50°C 的条件下持续 30 秒。使用其他类似溶剂清洗前，请先确认使用的溶剂不会对 LED 的封装和环氧树脂部分造成损伤。

超声波清洗也是有效的方法，一般最大功率不应超过 300W，否则可能对 LED 造成损伤。请根据具体的情况预先测试清洗条件是否会对 LED 造成损伤。

It is recommended that alcohol be used as a solvent for cleaning after soldering. Cleaning is to go under 30°C for 3 minutes or 50°C for 30 seconds. When using other solvents, it should be confirmed beforehand whether the solvents will dissolve the package and the resin or not.

Ultrasonic cleaning is also an effective way for cleaning. But the influence of Ultrasonic cleaning on LED depends on factors such as ultrasonic power. Generally, the ultrasonic power should not be higher than 300W. Before cleaning, a pretest should be done to confirm whether any damage to LEDs will occur.

- * **注意:** 此一般指导原则并不适用于所有 PCB 设计和焊接设备的配置。具体工艺受到诸多因素的影响，请根据特定的PCB设计和焊接设备来确定焊接方案。
- * **Note:** This general guideline may not apply to all PCB designs and configurations of all soldering equipment. The technics in practise is influenced by many factors, it should be specialized base on the PCB designs and configurations of the soldering equipment..

使用注意事项（1）

Precautions (1)

1. 贮存:

Storage

- 本产品使用密封防潮抗静电袋包装，并附有干燥剂，未开封的产品有一年的保存时间。

Moisture proof and anti-electrostatic package with moisture absorbent material is used, to keep moisture to a minimum.

- 开封前，产品须存放在温度不高于 30℃，湿度不高于 60%RH 的环境中。

Before opening the package, the product should be kept at 30℃ or less and humidity less than 60% RH, and be used within a year.

- 开封后，产品须存放在温度不高于 30℃，湿度不高于 10%RH 的环境中，且应该在 168 小时（7 天）内使用完。建议工作环境为温度不高于 30℃，湿度不高于 60%RH。

After opening the package, the product should be stored at 30℃ or less and humidity less than 10%RH, and be soldered within 168 hours (7 days). It is recommended that the product be operated at the workshop condition of 30℃ or less and humidity less than 60%RH.

- 对于尚未焊接的 LED，如果吸湿剂或包装失效，或者产品没有符合以上有效存储条件，烘焙可以起到一定的性能恢复效果。烘焙条件：(60±5)℃，持续 24 小时。

If the moisture absorbent material has fade away or the LEDs have exceeded the storage time, baking treatment should be performed based on the following condition: (60±5)℃ for 24 hours.

2. 静电:

Static Electricity

静电和电涌会导致产品特性发生改变，例如正向电压降低等，如果情况严重甚至会损毁产品。所以在使用时必须采取有效的防静电措施。

所有相关的设备和机器都应该正确接地，同时必须采取其他防止静电和电涌的措施。

使用防静电手环，防静电垫子，防静电工作服、工作鞋、手套，防静电容器，都是有效的防止静电和电涌的措施。

Static electricity or surge voltage damages the LEDs. Damaged LEDs will show some unusual characteristic such as the forward voltage becomes lower, or the LEDs do not light at the low current. even not light.

All devices, equipment and machinery must be properly grounded. At the same time, it is recommended that wrist bands or anti-electrostatic gloves, anti-electrostatic containers be used when dealing with the LEDs.

使用注意事项（2）

Precautions (2)

3. 设计建议:

Design Consideration

设计电路时，通过 LED 的电流不能超过规定的最大值，同时，还需使用保护电阻，否则，微小的电压变化将会引起较大的电流变化，可能导致产品损毁。

建议使用以下（A）电路，该电路能够很好的调节通过每个 LED 的电流；不推荐使用（B）电路，该电路在持续的电压驱动下，LED 的正向电压（ V_F ）发生变化，电流会随之而发生变化，可能使某些 LED 承受高于规定的电流值。

In designing a circuit, the current through each LED must not exceed the absolute maximum rating specified for each LED. In the meanwhile, resistors for protection should be applied, otherwise slight voltage shift will cause big current change, burn out may happen.

It is recommended to use Circuit A which regulates the current flowing through each LED rather than Circuit B. When driving LEDs with a constant voltage in Circuit B, the current through the LEDs may vary due to the variation in Forward Voltage (V_F) of the LEDs. In the worst case, some LED may be subjected to stresses in excess of the Absolute Maximum Rating.

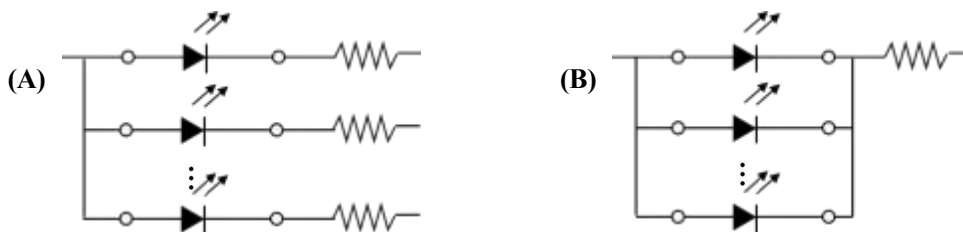

LED 的特性容易因为自身的发热和环境的温度的改变而发生改变。温度的升高会降低 LED 的发光效率、影响发光颜色等，所以在设计时应充分考虑散热的问题。

Thermal Design is paramount importance because heat generation may result in the Characteristics decline, such as brightness decreased, Color changed and so on. Please consider the heat generation of the LEDs when making the system design.

使用注意事项 (3)

Precautions (3)

4. 其他事项:

Others

直接用手拿取产品不但会污染封装树脂表面，也可能由于静电等因素导致产品性能的改变。过度的压力也可能直接影响封装内部的管芯和金线，因此请勿对产品施加过度压力，特别当产品处于高温状态下，例如在回流焊接过程中。

When handling the product, touching the encapsulant with bare hands will not only contaminate its surface, but also affect on its optical characteristics. Excessive force to the encapsulant might result in catastrophic failure of the LEDs due to die breakage or wire deformation. For this reason, please do not put excessive stress on LEDs, especially when the LEDs are heated such as during Reflow Soldering.

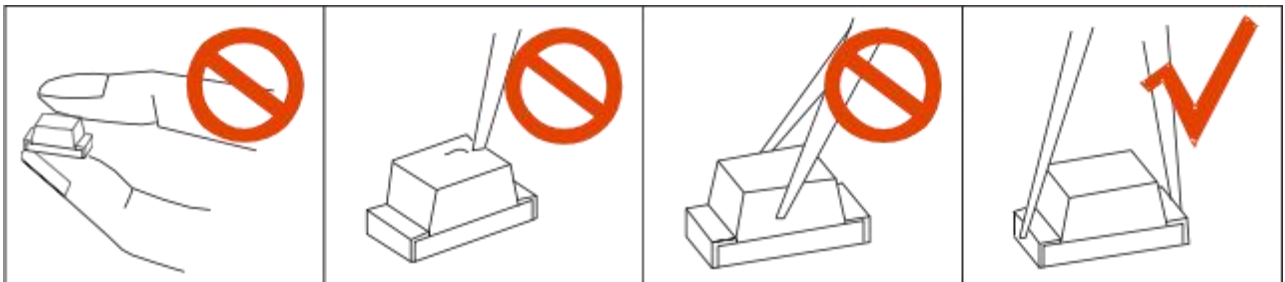

LED 的环氧树脂封装部分相当脆弱，请勿用坚硬、尖锐的物体刮、擦封装树脂部分。在用镊子夹取的时候也应当小心注意。

The epoxy resin of encapsulant is fragile, so please avoid scratch or friction over the epoxy resin surface. While handling the product with tweezers, do not hold by the epoxy resin, be careful.

5. 眼睛保护忠告:

Safety Advice For Human Eyes

LED 发光时，请勿直视发光光源，特别是对于一些光强较高的 LED，强光可能伤害你的眼睛。

Viewing direct to the light emitting center of the LEDs, especially those of great Luminous Intensity, will cause great hazard to human eyes. Please be careful.

X-ON Electronics

Largest Supplier of Electrical and Electronic Components

Click to view similar products for [Photodiodes](#) category:

Click to view products by [XINGLIGHT](#) manufacturer:

Other Similar products are found below :

[LTR-526AD](#) [OED-SP-7L](#) [LTR-536AB](#) [LTR-743DBM1-TA](#) [BPW 34 FS \(R18R\)-Z](#) [BPW 34 FAS-Z](#) [67-21SYGC-S349-TR8](#) [SFH 2200 A01](#)
[HFD3081-108-XBA](#) [BPW 34 S E9601](#) [VBPW34VR](#) [MICROFJ-60035-TSV-TR](#) [ZSPD-Z3215B-10-Z2](#) [PT908-7B\(BIN4\)](#) [PT204-6B\(BY\)\(K\)](#)
[PT928-6C/MA\(XBY\)](#) [PT908-7C\(BIN5\)](#) [PT968-8B\(6-2\)](#) [PT968-8C\(6-1\)](#) [PT204-6B\(BY\)\(J\)](#) [PT968-8B\(6-1\)](#) [PD70-01C/TR7\(BY\)](#) [PT968-](#)
[8C\(6-2\)](#) [XYC-PD3020F90-S3](#) [ZSPD-Z3215C-10A-Z2](#) [ZSPD-Z3227B-10C-Z3](#) [ZSPD-Z3227C-10-Z3](#) [PD15-22C/TR8\(BY\)](#) [ZPD-Z3224B-](#)
[T26-T15\(YPX\)](#) [ZSPD-Z5042C-A10-Z1](#) [ZSPD053B-S40](#) [PT334-6C\(BY\)\(K\)](#) [PT968-8C\(X1-X4\)XBY](#) [PT334-6B\(BY\)\(K\)](#) [PT928-6C\(5-2\)](#)
[PT334-6B\(BY\)\(L\)](#) [PT333-3B\(BY\)\(K\)](#) [PT334-6B\(BY\)\(M\)](#) [XYC-PD2835F30-F1](#) [XYC-PD204B-L1](#) [XYC-PD3A940FC-F1](#) [XYC-PD4335F90-](#)
[E2](#) [ZSPD808B](#) [ZSPD818B](#) [ZSPD034B-N](#) [ZSPD888C](#) [ZSPD053B-90-S90](#) [PD234-6B/L3](#) [PD70-01C/TR7\(ORI\)](#) [NCD2516RGI1](#)