

**XL-DZ304UYD/1****技术数据表** Technical Data Sheet**F3MM 黄发黄单孔灯座****特点 (characteristic) :**

- \* 外观尺寸 (L/W/H) :7.4\*4.6\*8.4mm  
Appearance dimension (L / w / h): 7.4\*4.6\*8.4mm
- \* 发光颜色及胶体: 黄色/黄色胶体  
Luminous color and colloid: Yellow Light /Yellow colloid
- \* 环保产品, 符合ROHS要求  
Environmental protection products meet ROHS requirements
- \* EIA规范标准包装  
EIA standard packaging
- \* 使用寿命长  
Long operating life
- \* 降低维护成本  
Reduced maintenance costs
- \* 高效能、启动快  
High energy efficiency, fast startup
- \* 低电压直流驱动  
Low voltage DC drive

**应用领域 (product application)**

- \* 物联网  
Internet of Things
- \* 医疗  
medical treatment
- \* 转换器  
converter
- \* 存储服务器和通信  
Storage servers and communication
- \* 状态指示器  
Status indicator
- \* 电子测试仪器  
Electronic testing instruments

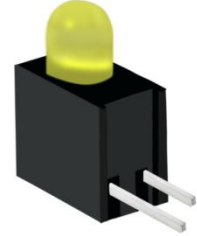

---

目录

Catalogue

---

电性参数  
Electrical Characteristics.....3

典型特性曲线  
Typical Characteristic Curves.....4

外形尺寸  
Outline Dimensions.....5

包装  
Packaging..... 6

使用注意事项  
Precautions..... 7

## 电性参数

## Electrical Characteristics

## 极限参数 (Absolute Maximum Ratings) (Ta=25°C)

项目参数Parameter	符号Symbol	数值Value	单位Unit
最大功耗 (Max Power Dissipation)	PD	50	mW
最大正向电流 (Max Continuous Forward Current)	IF	20	mA
最大反向电压 (Max Reverse Voltage)	VR	5	V
最大脉冲峰值电流 (Peak Forward Current)	IFP	80	mA
焊接温度/时间 (Lead Soldering Temperature/Time)	TSOL	260°C ≤ 6S	°C/S
工作环境 (Operating Temperature Range)	TOPR	-20 ~ +85 °C	°C
储存温度 (Storage Temperature Range)	TSTR	-40 ~ +85 °C	°C

## 光电参数 (Initial Electrical Optical Characteristics) (Ta=25°C)

项目参数Parameter	符号Symbol	最小值Min.	一般值Typ.	最大值Max.	单位Unit	测试条件Test conditions
发光强度 (Luminous Intensity)	Iv	80		120	mcd	IF=20mA
发光角度 (Viewing Angle)	2θ1/2	/	50°	/	deg	IF=20mA
峰值波长 (Peak Wave Length)	λp	/	590	/	nm	IF=20mA
主波长 (Dominant Wave Length)	λd	585	/	595	nm	IF=20mA
正向电压 (Forward Voltage)	VF	1.8	/	2.2	V	IF=20mA
反向电流 (Reverse Current)	IR	/	/	≤5	μA	VR=5V

## 备注 (Note) :

1. 此发光亮度为根据人眼对发光亮度之感应曲线之模拟发光强度符合CIE (国际光委会组织)  
The luminous intensity is the simulated luminous intensity according to the response curve of human eyes to luminous intensity, which conforms to CIE (International Light Commission)

1. 此发光角度之测量为其发光亮度一半时所测试之数据

The measurement of the luminous angle is the data measured when the luminous brightness is half.

3. 发光亮度保证误差正负15%

Guaranteed error of luminous brightness is plus or minus 15%.

# 典型特性曲线

## Typical Characteristics Curves

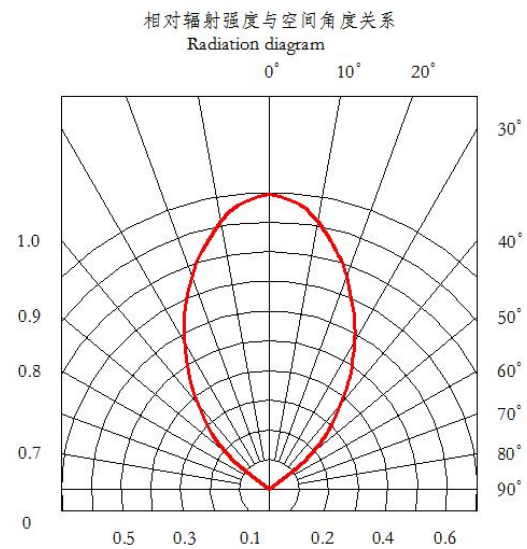
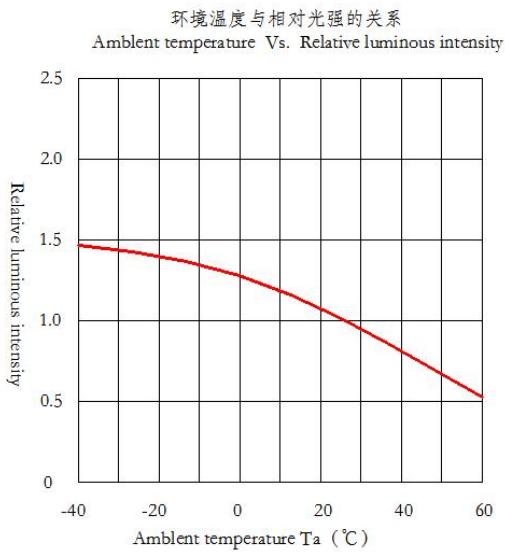
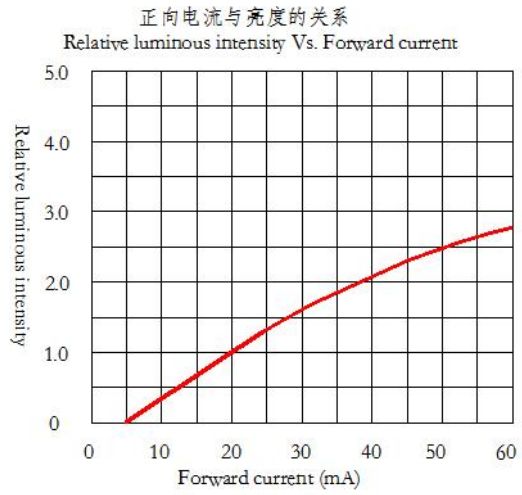
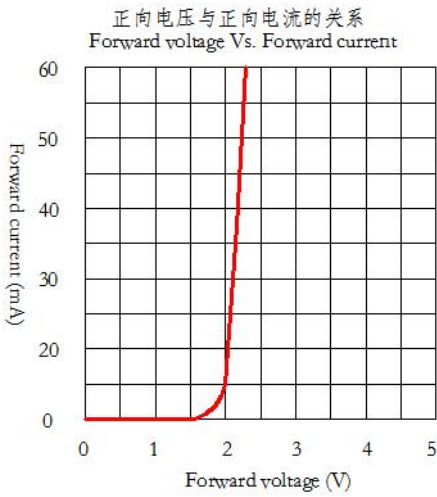
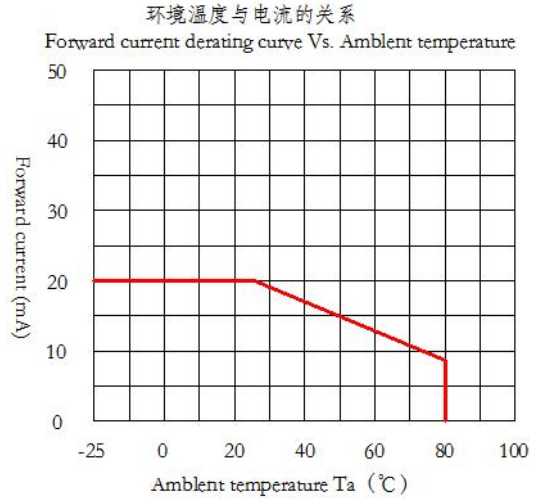
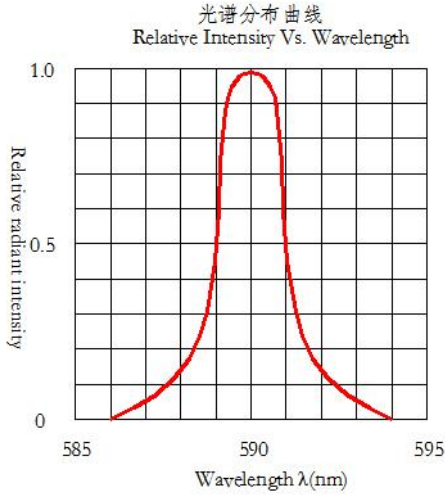

# 外形尺寸

## Outline Dimension

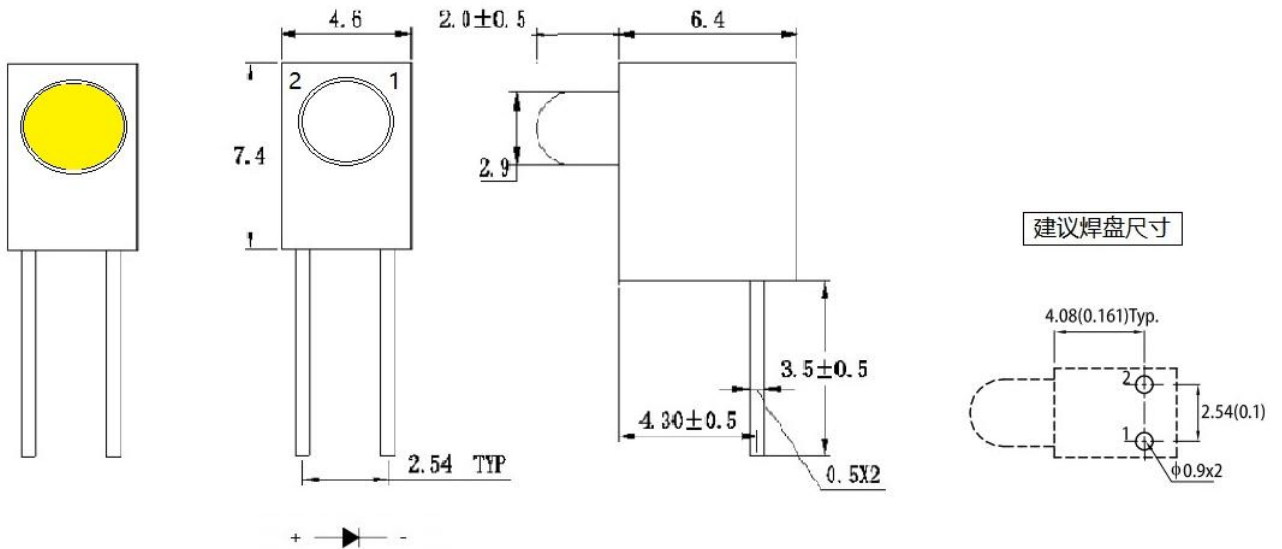

备注(Note):

1. 标注尺寸单位为毫米  
Dimensions are in millimeters.
2. 除特别标注外, 所有尺寸允许公差± 0.10mm .  
Tolerances unless mentioned are ± 0.10mm.

## 包装

### Packaging

\*袋装

In Bags

\*防潮抗静电包装

Moisture Proof and Anti-Electrostatic Foil Bag

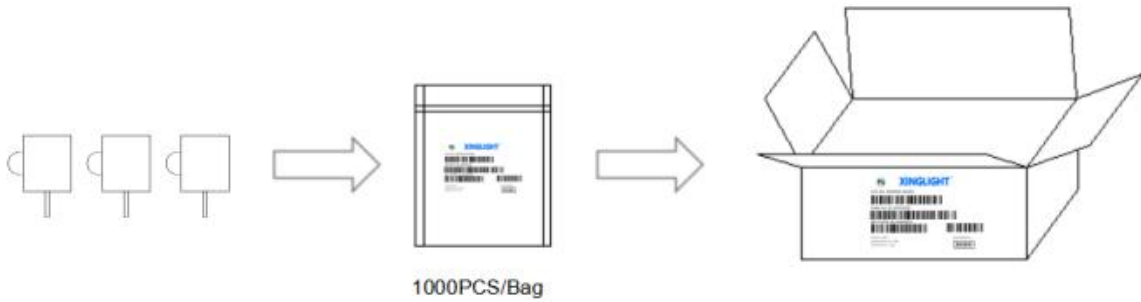

### ◇ 标签说明: Label Explantion

LOT NO: 批次信息

PART NO: 产品型号

BIN CODE: 产品名称

WL: 波长范围

IV: 光强范围

VF: 电压范围



---

## 使用注意事项 (1)

---

### Precautions (1)

#### 1、贮存:

##### Storage

\* 本产品使用密封防潮抗静电袋包装, 并附有干燥剂, 未开封的产品有一年的保存时间。

\* Moisture proof and anti-electrostatic package with moisture absorbent material is used, to keep moisture to a minimum.

\* 开封前, 产品须存放在温度不高于 30°C, 湿度不高于 40%RH 的环境中。

\* Before opening the package, the product should be kept at 30°C or less and humidity less than 40% RH, and be used within a year.

\* 开封后, 产品须存放在温度不高于 30°C, 湿度不高于 10%RH 的环境中, 且应该在 24小时(1天) 内使用完; 且贴片后应尽快做焊接。建议工作环境为温度不高于 30°C, 湿度不高于 40%RH。

\*After opening the package, the product should be stored at 30°C or less and humidity less than 10%RH, and be soldered within 24 hours (1 day). And it should be welded as soon as possible after the patch. It is recommended that the product be operated at the workshop condition of 30°C or less and humidity less than 40%RH.

\* 对于尚未焊接的 LED, 如果吸湿剂或包装失效, 或者产品没有符合以上有效存储条件, 烘焙可以起到一定的性能恢复效果。烘焙条件:  $60 \pm 5$  °C, 持续24 小时。

\*If the moisture absorbent material has fade away or the LEDs have exceeded the storage time, baking treatment should be performed based on the following condition:  $(60 \pm 5)$ °C for 24 hours.

#### 2、静电:

##### Static Electricity

\* 静电和电涌会导致产品特性发生改变, 例如正向电压降低等, 如果情况严重甚至会损毁产品。所以在使用时必须采取有效的防静电措施。

所有相关的设备和机器都应该正确接地, 同时必须采取其他防止静电和电涌的措施。使用防静电手环, 防静电垫子, 防静电工作服、工作鞋、手套, 防静电容器, 都是有效的防止静电和电涌的措施; 严禁使用普通塑料制品。建议在作业过程中, 使用离子风扇来压制静电的产生。距离LED元件1英尺距离的环境范围内静电场电压小于100V

\* Static electricity or surge voltage damages the LEDs. Damaged LEDs will show some unusual characteristic such as the forward voltage becomes lower, or the LEDs do not light at the low current. even not light.

All devices, equipment and machinery must be properly grounded. At the same time, it is recommended that wrist bands or anti-electrostatic gloves, anti-electrostatic containers be used when dealing with the LEDs. Using ordinary plastic products are strictly prohibited. It is recommended to use ion fans to suppress the static electricity generation during the operation. The static field voltage is less than 100V within the ambient range of 1 foot distance from the LED element.

## 使用注意事项 (2)

### Precautions (2)

#### 3、设计建议:

##### Design Consideration

\* 设计电路时, 通过 LED 的电流不能超过规定的最大值, 同时, 还需使用保护电阻, 否则, 微小的电压变化将会引起较大的电流变化, 可能导致产品损毁。

建议使用以下 (A) 电路, 该电路能够很好的调节通过每个 LED 的电流; 不推荐使用 (B) 电路, 该电路在持续的电压驱动下, LED 的正向电压 ( $V_F$ ) 发生变化, 电流会随之而发生变化, 可能使某些 LED 承受高于规定的电流值。

\* In designing a circuit, the current through each LED must not exceed the absolute maximum rating specified for each LED. In the meanwhile, resistors for protection should be applied, otherwise slight voltage shift will cause big current change, burn out may happen.

It is recommended to use Circuit A which regulates the current flowing through each LED rather than Circuit B. When driving LEDs with a constant voltage in Circuit B, the current through the LEDs may vary due to the variation in Forward Voltage ( $V_F$ ) of the LEDs. In the worst case, some LED may be subjected to stresses in excess of the Absolute Maximum Rating.

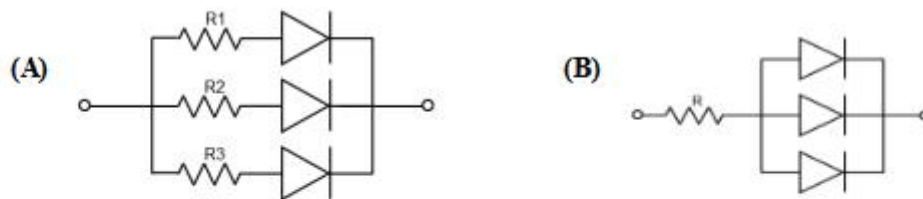

光电参数公差:

正向电压 $V_F$  /  $V_F$ :  $\pm 0.1V$

亮度 $I_V$  /  $I_V$ :  $\pm 15\%$

波长 $\lambda$  /  $\lambda$ :  $\pm 1nm$

\* LED 的特性容易因为自身的发热和环境的温度的改变而发生改变。温度的升高会降低 LED 的发光效率、影响发光颜色等, 所以在设计时应充分考虑散热的问题。

\* Thermal Design is paramount importance because heat generation may result in the Characteristics decline, such as brightness decreased, Color changed and so on. Please consider the heat generation of the LEDs when making the system design.



## 使用注意事项 (3)

### Precautions (3)

#### 4、其他事项:

##### Others:

\*直接用手拿取产品不但会污染封装树脂表面,也可能由于静电等因素导致产品性能的改变。过度的压力也可能直接影响封装内部的管芯和金线,因此请勿对产品施加过度压力,特别当产品处于高温状态下,例如在回流焊接过程中。

\*When handling the product, touching the encapsulant with bare hands will not only contaminate its surface, but also affect on its optical characteristics. Excessive force to the encapsulant might result in catastrophic failure of the LEDs due to die breakage or wire deformation. For this reason, please do not put excessive stress on LEDs, especially when the LEDs are heated such as during Reflow Soldering.

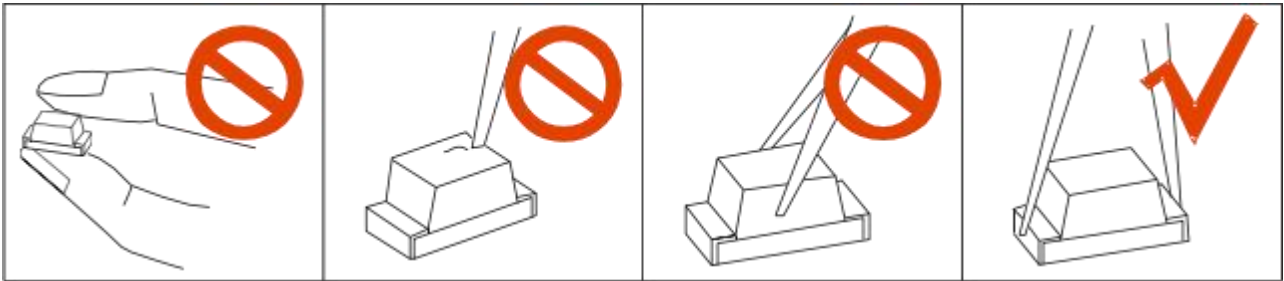

\*LED 的环氧树脂封装部分相当脆弱,请勿用坚硬、尖锐的物体刮、擦封装树脂部分。在用镊子夹取的时候也应当小心注意。

\*The epoxy resin of encapsulant is fragile, so please avoid scratch or friction over the epoxy resin surface. While handling the product with tweezers, do not hold by the epoxy resin, be careful.

#### 5、眼睛保护忠告:

##### Safety Advice For Human Eyes

\*LED 发光时,请勿直视发光光源,特别是对于一些光强较高的 LED,强光可能伤害你的眼睛。

\*Viewing direct to the light emitting center of the LEDs, especially those of great Luminous Intensity, will cause great hazard to human eyes. Please be careful.

## X-ON Electronics

Largest Supplier of Electrical and Electronic Components

*Click to view similar products for [Standard LEDs - SMD category](#):*

*Click to view products by [XINGLIGHT manufacturer](#):*

Other Similar products are found below :

[LTST-C190KYKT](#) [LTST-C19GD2WT](#) [LTST-N683GBEW](#) [LTW-170ZDC](#) [LTW-M140SZS40](#) [LTW-M140ZVS](#) [598-8110-100F](#) [91-21SUBCS400-A6TR7](#) [AAAF5060QBFSEEZGS](#) [APT1608QGW](#) [99-213/R6C-AR2T1B/2C](#) [SML-LX0606SISUGC/A](#) [SML-LXR851SIUPGUBC](#) [LT1ED53A](#) [AM27ZGC03](#) [APFA3010SURKCGKQBDC](#) [APHK1608VGCA](#) [APT2012QGW](#) [LTST-008BGEW](#) [LTW-010DCG](#) [LTW-020ZDCG](#) [LTW-21TS5](#) [LTW-220DS5](#) [LO T67F-V1AB-24-1](#) [598-8330-117F](#) [CMDA20AYAA7D1S](#) [95-21SURCS530-A3TR10](#) [HSMQ-C177](#) [598-8040-100F](#) [598-8070-100F](#) [598-8140-100F](#) [598-8610-200F](#) [SML-LXL1209SYC/ATR](#) [CMD91-21VRC/TR7](#) [SML-512PWT86A](#) [SMF-2432GYC-TR](#) [EASV3015RGYA0](#) [LTST-C190KFKT-5A](#) [LTST-C194TBKT-5A](#) [CLX6E-FKC-CH1M1D1BB7C3D3](#) [SML-LXL0805USBC-TR](#) [SML-LX2835SYSUGCTR](#) [LTW-M670ZVS-M5](#) [APA2106ZGC/G](#) [CLMXB-FKA-CbcfghjnpACBB79463](#) [VFA1101W-5AY3B2-TR](#) [LCB P473-P2R2-3J7L-1-Z](#) [HSMR-C197](#) [LW A67C-S2U1-FK0KM0](#) [LW A673-P1S1-FK0PM0](#)