

Description

The XB2204 series is a positive voltage regulator IC fabricated by high voltage EPNP process.

The XB2204 has features of wide input voltage range, high accuracy, high ripple rejection, low dropout voltage, low noise, current limit and ultra-low quiescent current which make it ideal for use in various USB and portable devices.

The IC consists of a voltage reference, an error amplifier, a resistor network for setting output voltage, a current limit circuit for current protection, and a chip enable circuit.

The XB2204 has 1.8V 3.3V 5.0V ADJ fixed voltage versions and adjustable voltage version.

Pin Assignments

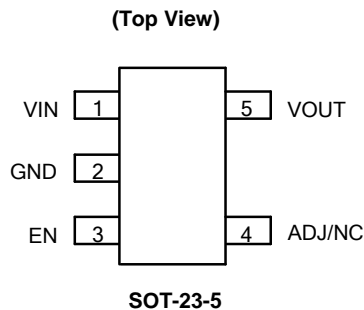

- Notes:
4. The substrate/exposed pad should be connected to GND.
 5. The substrate/exposed pad should be connected to VIN.
 6. The exposed pad should be connected to GND for better dissipation.

Features

- Wide Input Voltage Range: 2.6V to 24V
- Wide Output Voltage Range: 1.24V to 22V
- Excellent Ripple Rejection: 60dB@ f = 1kHz
- Low Dropout Voltage: $V_{DROP} = 100mV @ I_{OUT} = 100\mu A$
- Low Ground Current
- High Output Voltage Accuracy
- Compatible with Low ESR Ceramic Capacitor
- Excellent Line/Load Regulation
- Thermal Shutdown Function
- **Totally Lead-Free & Fully RoHS Compliant (Notes 1 & 2)**
- **Halogen and Antimony Free. "Green" Device (Note 3)**

Applications

- Battery-powered Equipment
- Laptop, Palmtops, Notebook Computers
- Portable Information Appliances

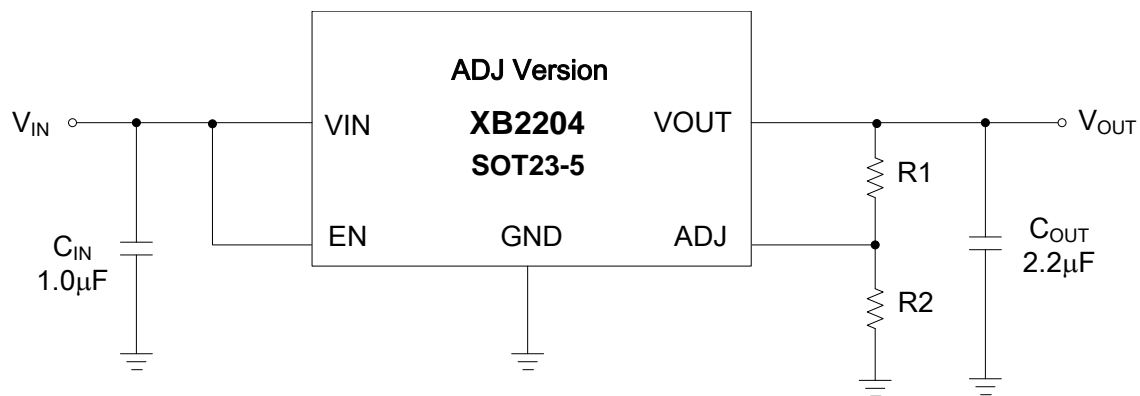
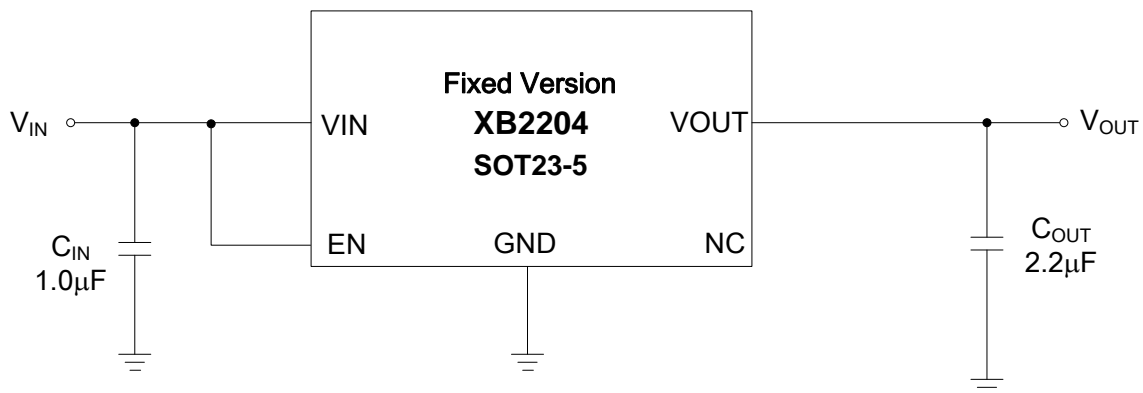

$$V_{OUT} = V_{REF}(1 + (R1/R2))$$

Pin Number	Pin Name	Function
SOT-23-5		
1	VIN	Input voltage
2	GND	Ground
3	EN	Enable input
4	ADJ/NC	Adjust output for ADJ version/Not connected for fixed version
5	VOUT	Regulated output voltage

Functional Block Diagram

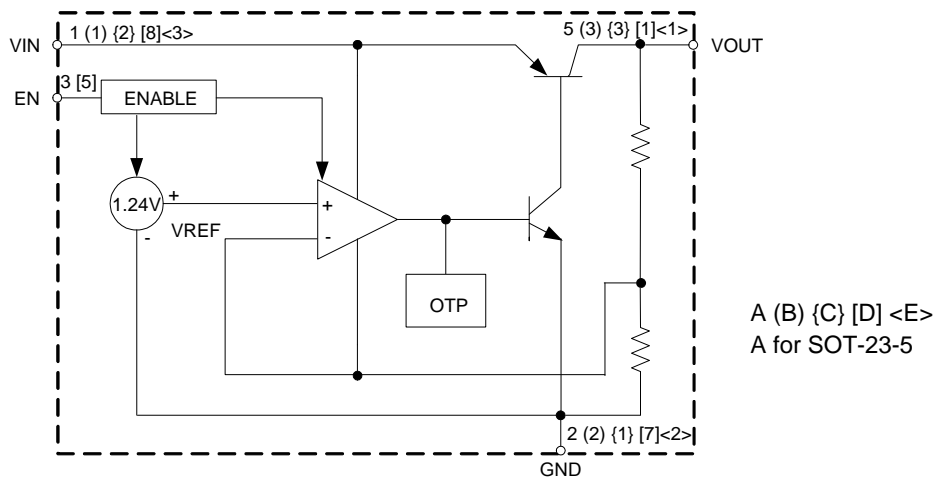

Fixed Output Voltage

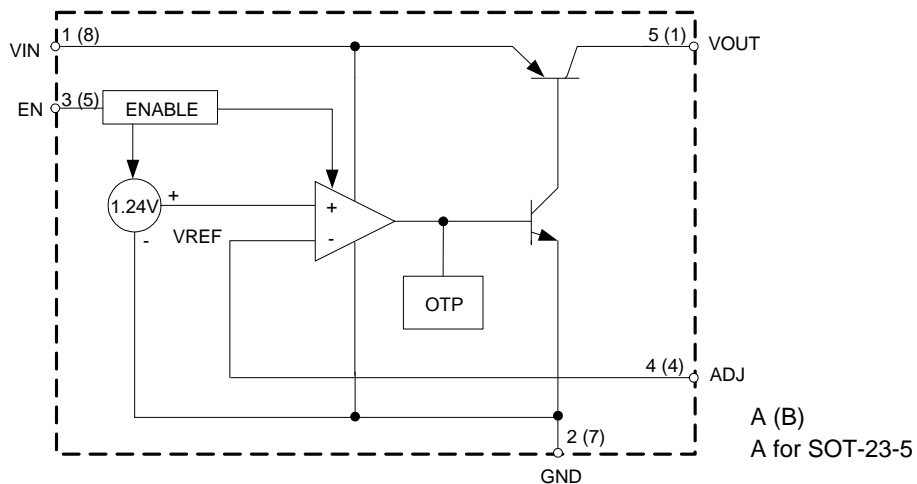

Adjustable Output Voltage

Symbol	Parameter	Rating		Unit
V _{IN}	Supply Input Voltage	38		V
V _{CE}	Enable Input Voltage	38		V
I _{OUT}	Output Current	250		mA
T _{LEAD}	Lead Temperature (Soldering, 10sec)	+260		°C
T _J	Operating Junction Temperature	+150		°C
θ _{JA}	Thermal Resistance	SOT-23-5	250	°C/W
T _{STG}	Storage Temperature Range	-65 to +150		°C
—	ESD (Machine Model)	275		V
—	ESD (Human Body Model)	2000		V

- Notes:
7. Stresses greater than those listed under “Absolute Maximum Ratings” may cause permanent damage to the device. These are stress ratings only, and functional operation of the device at these or any other conditions beyond those indicated under “Recommended Operating Conditions” is not implied. Exposure to “Absolute Maximum Ratings” for extended periods may affect device reliability.
 8. θ_{JA} is measured with the component mounted on a 2-Layer FR-4 PCB board with 1.5cm*1.5cm thermal sink pad in free air.

Recommended Operating Conditions

Symbol	Parameter	Min	Max	Unit
V _{IN}	Supply Input Voltage	2.6 (Note 9)	24	V
T _J	Operating Junction Temperature	-40	+125	°C

- Note:
9. Minimum recommended input voltage is the larger of 2.6V or V_{OUT} + 1V. Below this value the device may enter drop-out conditions and cease to regulate the output voltage correctly.

Symbol	Parameter	Conditions	Min	Typ	Max	Unit	
V _{OUT}	Output Voltage	Variation from Specified V _{OUT}	V _{OUT} ×98%	—	V _{OUT} ×102%	V	
V _{REF}	Reference Voltage	—	1.215	1.24	1.265	V	
V _{IN}	Input Voltage	—	—	—	24	V	
I _{OUT(max)}	Maximum Output Current	V _{IN} -V _{OUT} = 1V, V _{OUT} = 98% × V _{OUT}	150	200	—	mA	
ΔV _{OUT} /ΔV _{IN}	Line Regulation	V _{OUT} +1V ≤ V _{IN} ≤ 24V	—	0.05	—	%	
ΔV _{OUT} /V _{OUT}	Load Regulation	1mA ≤ I _{OUT} ≤ 150mA	—	0.5	—	%	
V _{DROP}	Dropout Voltage	I _{OUT} = 100μA	—	100	150	mV	
		I _{OUT} = 50mA	—	270	350		
		I _{OUT} = 100mA	—	320	460		
		I _{OUT} = 150mA	—	360	500		
I _{GND}	Ground Current	I _{OUT} = 0A	—	20	—	μA	
		I _{OUT} = 100μA	—	50	—		
		I _{OUT} = 50mA	—	0.5	—	mA	
		I _{OUT} = 100mA	—	1.3	—		
		I _{OUT} = 150mA	—	2.5	—		
I _{STD}	Standby Current	V _{IN} = V _{OUT} +1V V _{EN} in OFF Mode	—	0.01	1.0	μA	
PSRR	Power Supply Rejection Ration	Ripple 0.5V _{P-P} V _{IN} = V _{OUT} +1V	f = 100Hz	—	60	—	dB
			f = 1kHz	—	60	—	
ΔV _{OUT} /(V _{OUT} ×ΔT)	Output Voltage Temperature Coefficient	I _{OUT} = 100μA, -40°C ≤ T _J ≤ +125°C	—	±100	—	ppm/°C	
V _{NOI}	RMS Output Noise	T _J = +25°C, 10Hz ≤ f ≤ 100kHz	—	30	—	μV _{rms}	
I _{ADJ}	ADJ Pin Current	I _{OUT} = 100μA	—	0.5	—	μA	
I _{EN}	EN Pin Current	V _{EN} = V _{OUT} +1V	—	1	—	μA	
—	EN "High" Voltage	EN Input Voltage "High"	2.0	—	—	V	
—	EN "Low" Voltage	EN Input Voltage "Low"	—	—	0.4	V	
θ _{JC}	Thermal Resistance (Junction to Case)	SOT-23-5	—	43	—	°C/W	

Output Voltage vs. Output Current

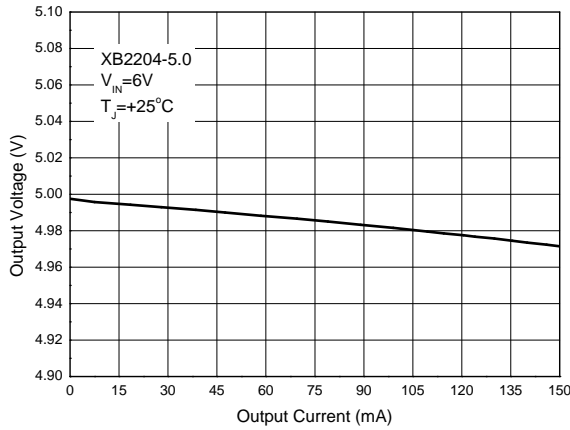

Output Voltage vs. Output Current

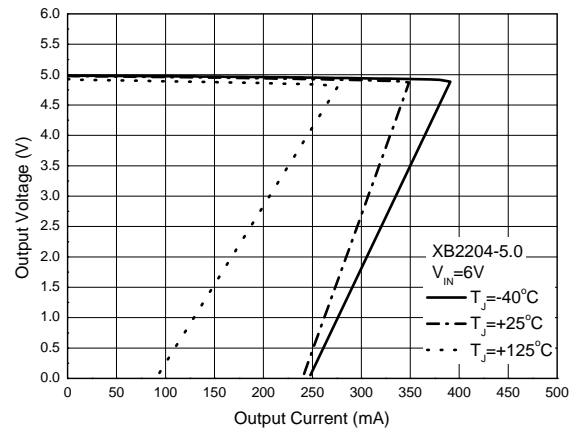

Output Voltage vs. Output Current

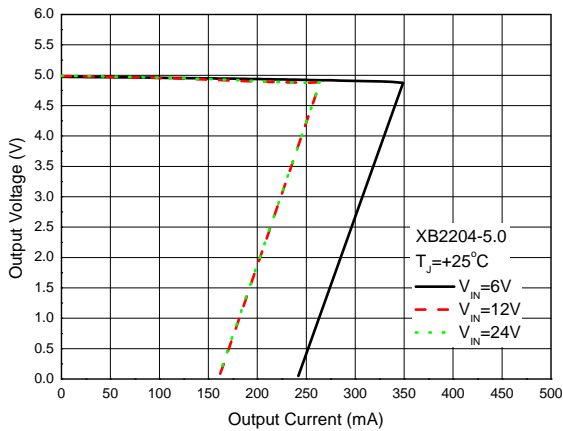

Dropout Voltage vs. Output Current

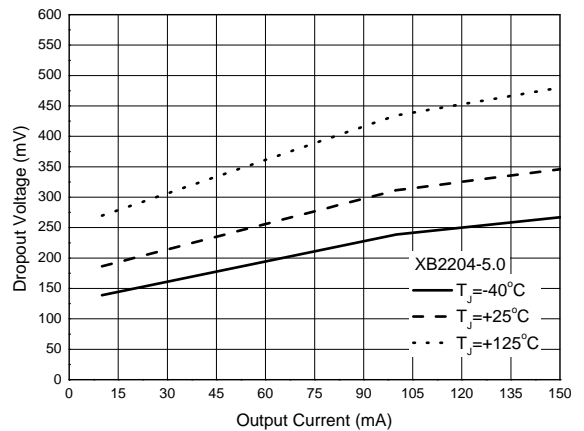

Dropout Voltage vs. Junction Temperature

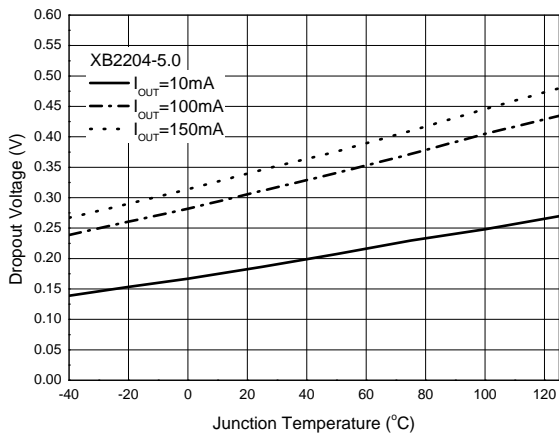

Output Voltage vs. Input Voltage

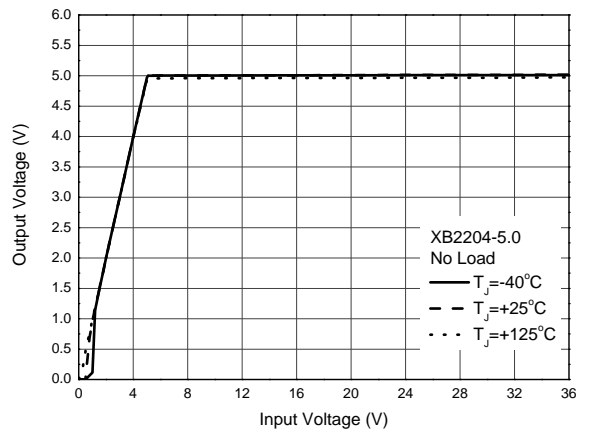

Output Voltage vs. Input Voltage

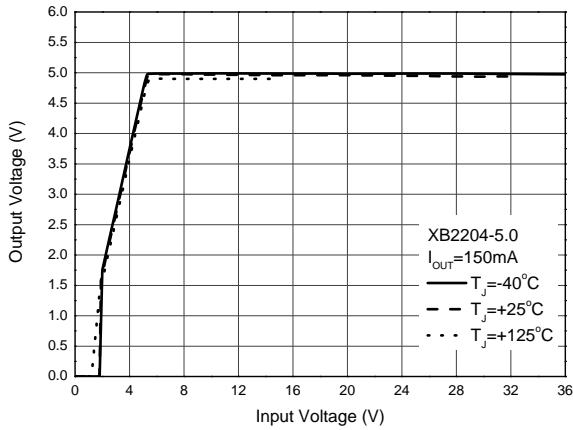

Output Voltage vs. Junction Temperature

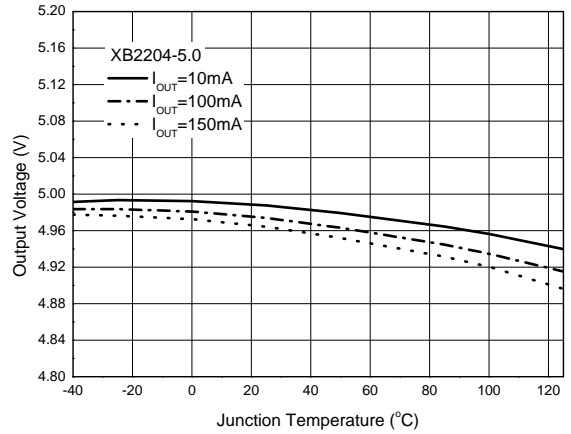

Supply Current vs. Input Voltage

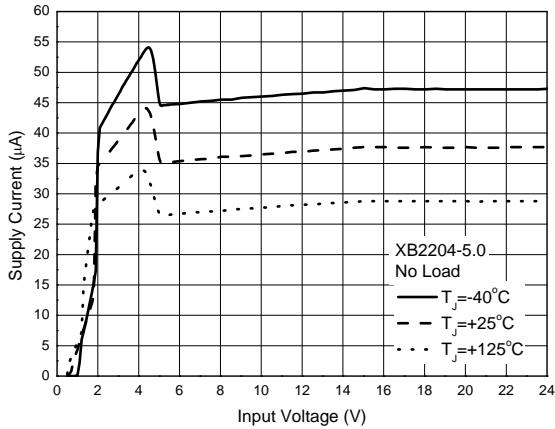

Ground Current vs. Junction Temperature

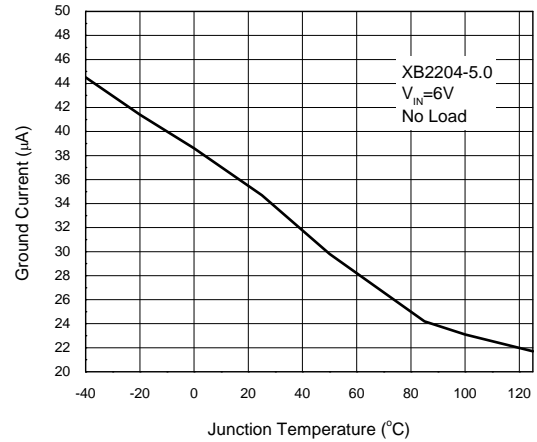

Ground Current vs. Output Current

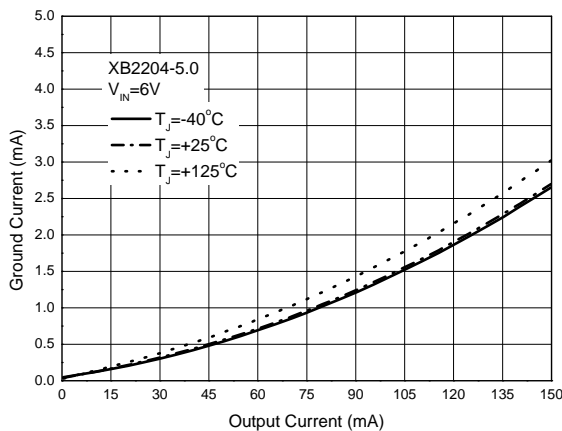

Enable Current vs. Enable Input Voltage

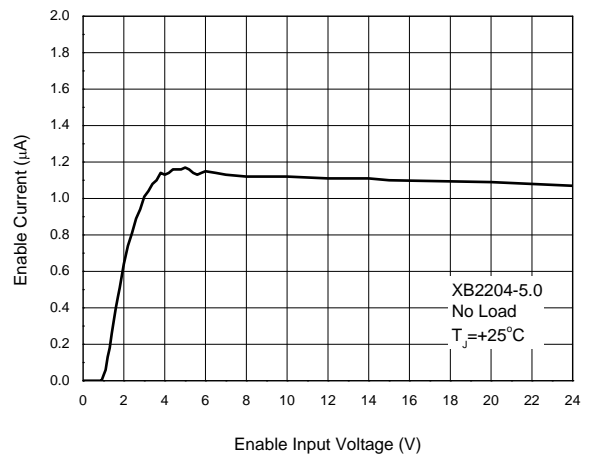

Line Transient

(Conditions: $V_{IN}=V_{EN}=3.5V$ to $8V$, $C_{IN}=1.0\mu F$, $C_{OUT}=2.2\mu F$, $I_{OUT}=1mA$)

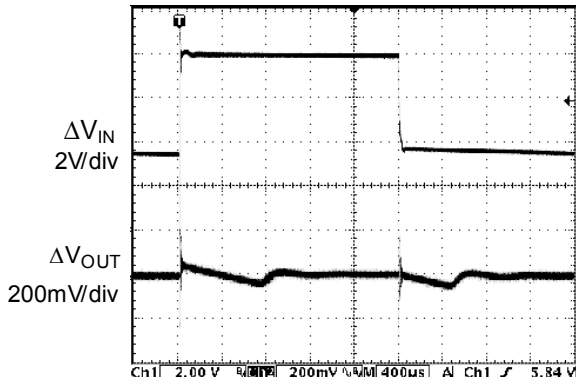

Line Transient

(Conditions: $V_{IN}=V_{EN}=5V$ to $15V$, $C_{IN}=1.0\mu F$, $C_{OUT}=2.2\mu F$, $I_{OUT}=1mA$)

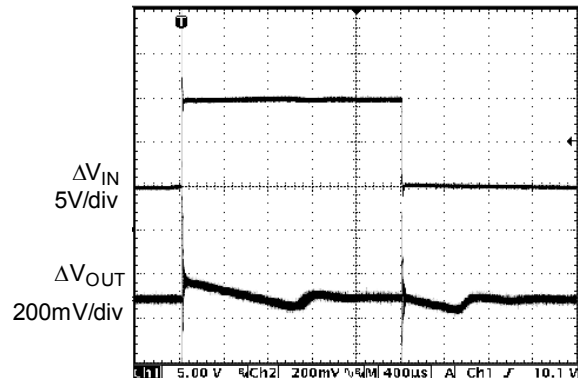

Load Transient

(Conditions: $V_{IN}=5V$, $C_{IN}=1.0\mu F$, $C_{OUT}=2.2\mu F$, $I_{OUT}=1mA$ to $50mA$)

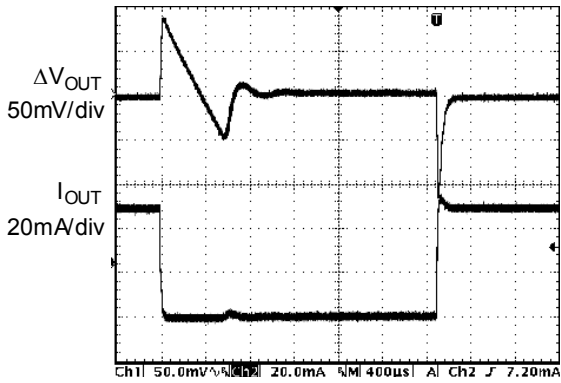

Load Transient

(Conditions: $V_{IN}=5V$, $C_{IN}=1.0\mu F$, $C_{OUT}=2.2\mu F$, $I_{OUT}=1mA$ to $150mA$)

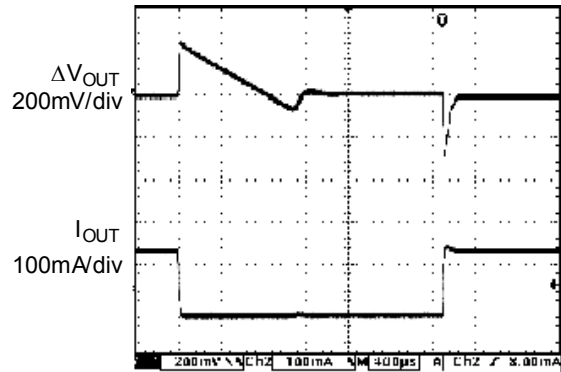

Enable Input Response



Start-up Response

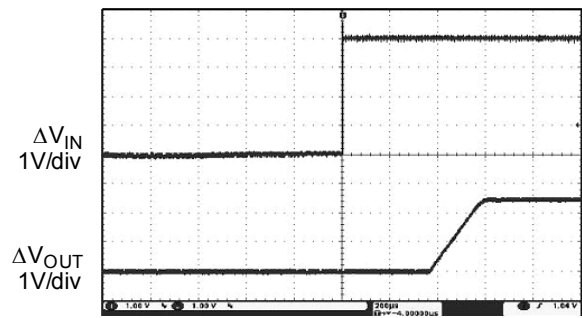

PSRR vs. Frequency
(Conditions: $V_{PP}=2V$, $I_{OUT}=10mA$)

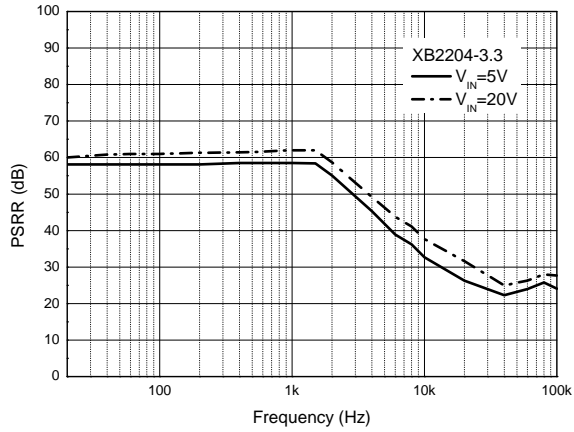

Output Voltage vs. Output Current

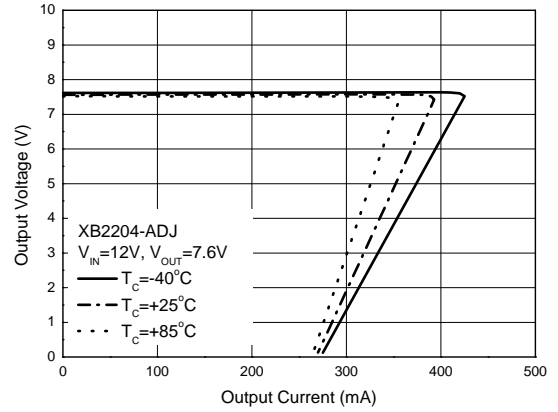

Maximum Output Current vs. Case Temperature

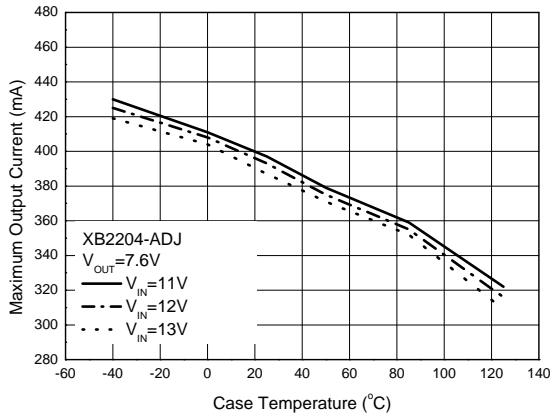

Case Temperature vs. Output Current

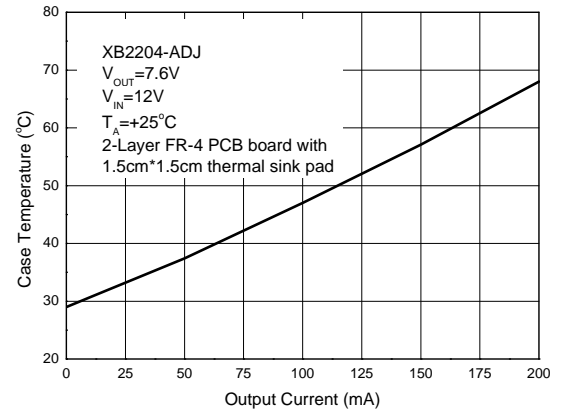

XB2121-1.8 SOT23-5

XB2204-3.3 SOT23-5

XB2204-5.0 SOT23-5

XB2204-ADJ SOT23-5

Temperature Range -40 to +85°C

(1) Package Type: SOT-23-5

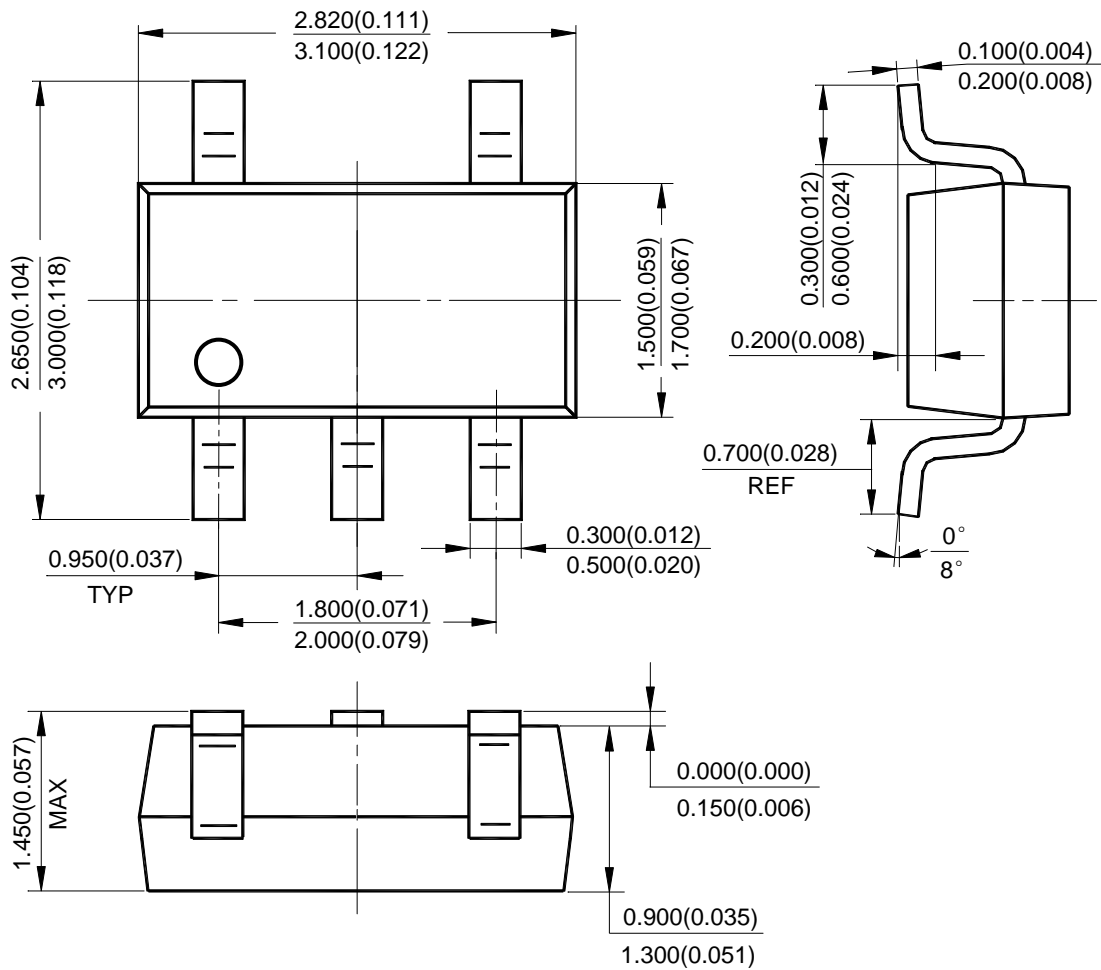

以上信息仅供参考. 如需帮助联系客服人员。谢谢 XINLUDA

X-ON Electronics

Largest Supplier of Electrical and Electronic Components

Click to view similar products for [xinluda](#) manufacturer:

Other Similar products are found below :

[XD74LS06](#) [XD74LS20](#) [XL2907-8](#) [XL62783](#) [XL1050](#) [XL3057W](#) [XL8574T](#) [XD74LS93](#) [XL293-20](#) [XL9555](#) [XD74LS154](#) [XD71055](#)
[XD74LS181](#) [XL2515-TSS](#) [XD3525](#) [XL2543-SS](#) [XD4059](#) [XH2596-3.3](#) [XD74HC245](#) [XD556](#) [XD54562](#) [XL1307](#) [XD82C55-5](#) [XD33035](#)
[XD54563](#) [XD74LS145](#) [XD232](#) [XL485-SS](#) [XD74HC573](#) [XD74HC4514Z](#) [XL7219](#) [XD14016](#) [XD74HC373](#) [XD4514](#) [XD74LS73](#) [XH2576-](#)
[3.3](#) [XH2576-ADJ](#) [XP8255](#) [XD62002](#) [XT336-2.5](#) [XD62004](#) [XD14514](#) [XD14069](#) [XD62003](#) [XP71055](#) [XH2596-12](#) [XL1000](#) [XD74LS30](#)
[XD74LS190](#) [XD7221](#)