

## FEATURES

- 3.3V 5.0V 12V ADJ and Adjustable Output Versions
- Adjustable Version Output Voltage Range, 1.23V to 37V (57V for HV Version)  $\pm 4\%$  Max Over Line and Load Conditions
- Specified 3A Output Current
- Wide Input Voltage Range, 40V Up to 60V for HV Version
- Requires Only 4 External Components
- 52 kHz Fixed Frequency Internal Oscillator
- TTL Shutdown Capability, Low Power Standby Mode
- High Efficiency
- Uses Readily Available Standard Inductors
- Thermal Shutdown and Current Limit Protection
- P+ Product Enhancement Tested

## APPLICATIONS

- Simple High-Efficiency Step-Down (Buck) Regulator
- Efficient Pre-Regulator for Linear Regulators
- On-Card Switching Regulators
- Positive to Negative Converter (Buck-Boost)

## TYPICAL APPLICATION

(Fixed Output Voltage Versions)

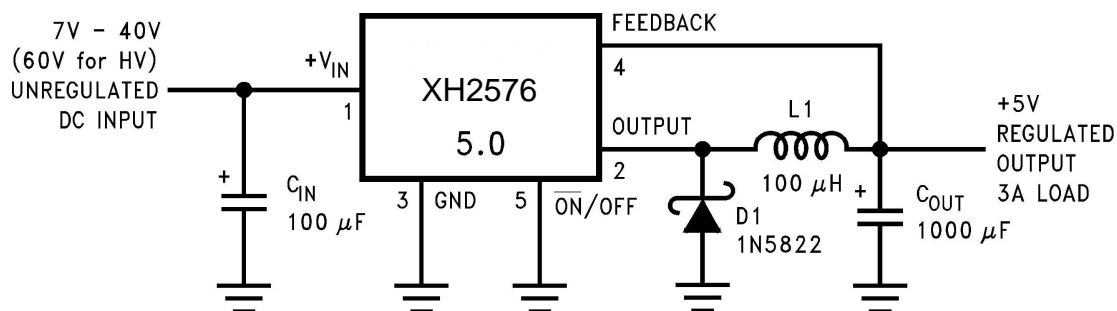

Figure 1.

## DESCRIPTION

The XH2576 series of regulators are monolithic integrated circuits that provide all the active functions for a step-down (buck) switching regulator, capable of driving 3A load with excellent line and load regulation. These devices are available in fixed output voltages of 3.3V 5.0V 12V ADJ and an adjustable output version.

Requiring a minimum number of external components, these regulators are simple to use and include internal frequency compensation and a fixed-frequency oscillator.

The XH2576 series offers a high-efficiency replacement for popular three-terminal linear regulators. It substantially reduces the size of the heat sink, and in some cases no heat sink is required.

A standard series of inductors optimized for use with the XH2576 are available from several different manufacturers. This feature greatly simplifies the design of switch-mode power supplies.

Other features include a specified  $\pm 4\%$  tolerance on output voltage within specified input voltages and output load conditions, and  $\pm 10\%$  on the oscillator frequency. External shutdown is included, featuring 50  $\mu$ A (typical) standby current. The output switch includes cycle-by-cycle current limiting, as well as thermal shutdown for full protection under fault conditions.

**Block Diagram**

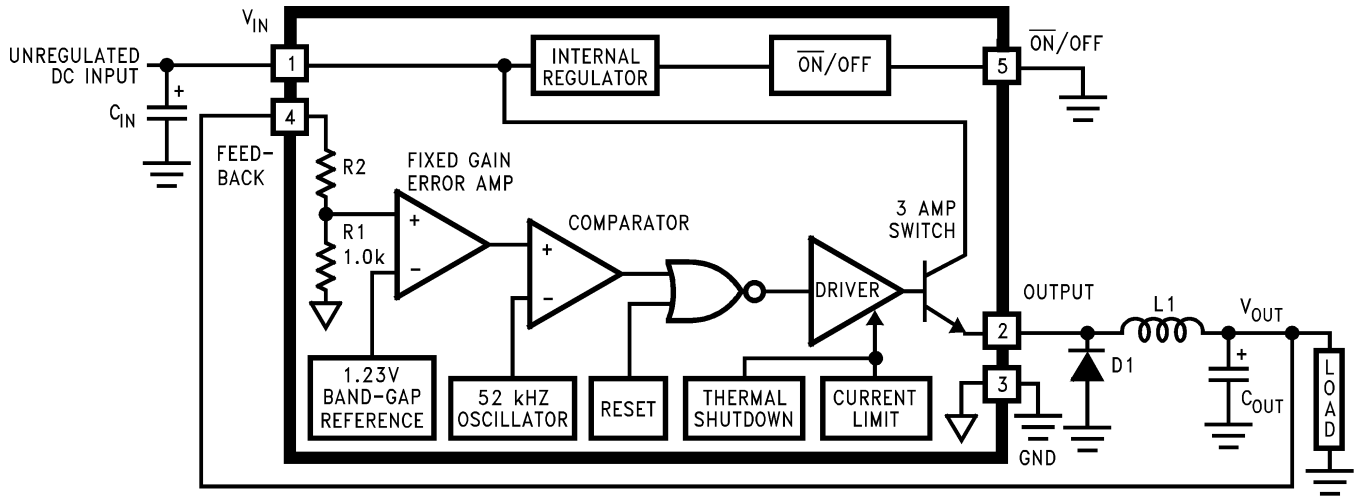

3.3V R2 = 1.7k  
 5V, R2 = 3.1k  
 12V, R2 = 8.84k  
 15V, R2 = 11.3k  
 For ADJ. Version  
 R1 = Open, R2 = 0Ω  
 Patent Pending

### ABSOLUTE MAXIMUM RATINGS <sup>(1)(2)</sup>

Maximum Supply Voltage	XH2576	45V
$\overline{\text{ON}}$ /OFF Pin Input Voltage		$-0.3V \leq V \leq +V_{\text{IN}}$
Output Voltage to Ground	(Steady State)	-1V
Power Dissipation		Internally Limited
Storage Temperature Range		-65°C to +150°C
Maximum Junction Temperature		150°C
Minimum ESD Rating	(C = 100 pF, R = 1.5 kΩ)	2 kV
Lead Temperature	(Soldering, 10 Seconds)	260°C

- (1) Absolute Maximum Ratings indicate limits beyond which damage to the device may occur. Operating Ratings indicate conditions for which the device is intended to be functional, but do not ensure specific performance limits. For ensured specifications and test conditions, see ELECTRICAL CHARACTERISTICS ALL OUTPUT VOLTAGE VERSIONS.

### OPERATING RATINGS

Temperature Range	XH2576	$-40^{\circ}\text{C} \leq T_J \leq +125^{\circ}\text{C}$
Supply Voltage	XH2576	40V
	XH2576	60V

### ELECTRICAL CHARACTERISTICS XH2576-3.3

Specifications with standard type face are for  $T_J = 25^{\circ}\text{C}$ , and those with **boldface type** apply over full Operating Temperature Range.

Symbol	Parameter	Conditions	XH2576-3.3		Units (Limits)
			Typ	Limit <sup>(1)</sup>	
<b>SYSTEM PARAMETERS Test Circuit Figure 21 and Figure 22<sup>(2)</sup></b>					
$V_{\text{OUT}}$	Output Voltage	$V_{\text{IN}} = 12\text{V}$ , $I_{\text{LOAD}} = 0.5\text{A}$ Circuit of Figure 21 and Figure 22	3.3	3.234 3.366	V V(Min) V(Max)
$V_{\text{OUT}}$	Output Voltage XH2576	$6\text{V} \leq V_{\text{IN}} \leq 40\text{V}$ , $0.5\text{A} \leq I_{\text{LOAD}} \leq 3\text{A}$ Circuit of Figure 21 and Figure 22	3.3	3.168/ <b>3.135</b> 3.432/ <b>3.465</b>	V V(Min) V(Max)
$V_{\text{OUT}}$	Output Voltage	$6\text{V} \leq V_{\text{IN}} \leq 60\text{V}$ , $0.5\text{A} \leq I_{\text{LOAD}} \leq 3\text{A}$ Circuit of Figure 21 and Figure 22	3.3	3.168/ <b>3.135</b> 3.450/ <b>3.482</b>	V V(Min) V(Max)
$\eta$	Efficiency	$V_{\text{IN}} = 12\text{V}$ , $I_{\text{LOAD}} = 3\text{A}$	75		%

- (1) All limits specified at room temperature (standard type face) and at temperature extremes (bold type face). All room temperature limits are 100% production tested. All limits at temperature extremes are specified via correlation using standard Statistical Quality Control (SQC) methods.
- (2) External components such as the catch diode, inductor, input and output capacitors can affect switching regulator system performance. When the XH2576 is used as shown in Figure 21 and Figure 22, system performance will be as shown in ELECTRICAL CHARACTERISTICS ALL OUTPUT VOLTAGE VERSIONS.

### ELECTRICAL CHARACTERISTICS XH2576-5.0

Specifications with standard type face are for  $T_J = 25^\circ\text{C}$ , and those with Figure 21 and Figure 22 boldface type apply over full Operating Temperature Range.

Symbol	Parameter	Conditions	XH2576-5.0		Units (Limits)
			Typ	Limit (1)	
<b>SYSTEM PARAMETERS Figure 21 and Figure 22<sup>(2)</sup></b>					
$V_{OUT}$	Output Voltage	$V_{IN} = 12\text{V}$ , $I_{LOAD} = 0.5\text{A}$ Circuit of Figure 21 and Figure 22	5.0	4.900 5.100	V V(Min) V(Max)
$V_{OUT}$	Output Voltage XH2576	$0.5\text{A} \leq I_{LOAD} \leq 3\text{A}$ , $8\text{V} \leq V_{IN} \leq 40\text{V}$ Circuit of Figure 21 and Figure 22	5.0	4.800/ <b>4.750</b> 5.200/ <b>5.250</b>	V V(Min) V(Max)
$V_{OUT}$	Output Voltage	$0.5\text{A} \leq I_{LOAD} \leq 3\text{A}$ , $8\text{V} \leq V_{IN} \leq 60\text{V}$ Circuit of Figure 21 and Figure 22	5.0	4.800/ <b>4.750</b> 5.225/ <b>5.275</b>	V V(Min) V(Max)
$\eta$	Efficiency	$V_{IN} = 12\text{V}$ , $I_{LOAD} = 3\text{A}$	77		%

- (1) All limits specified at room temperature (standard type face) and at temperature extremes (bold type face). All room temperature limits are 100% production tested. All limits at temperature extremes are specified via correlation using standard Statistical Quality Control (SQC) methods.
- (2) External components such as the catch diode, inductor, input and output capacitors can affect switching regulator system performance. When the XH2576 is used as shown in Figure 21 and Figure 22, system performance will be as shown in ELECTRICAL CHARACTERISTICS ALL OUTPUT VOLTAGE VERSIONS.

### ELECTRICAL CHARACTERISTICS XH2576-12

Specifications with standard type face are for  $T_J = 25^\circ\text{C}$ , and those with **boldface type** apply over full Operating Temperature Range.

Symbol	Parameter	Conditions	XH2576-12		Units (Limits)
			Typ	Limit (1)	
<b>SYSTEM PARAMETERS Test Circuit Figure 21 and Figure 22<sup>(2)</sup></b>					
$V_{OUT}$	Output Voltage	$V_{IN} = 25\text{V}$ , $I_{LOAD} = 0.5\text{A}$ Circuit of Figure 21 and Figure 22	12	11.76 12.24	V V(Min) V(Max)
$V_{OUT}$	Output Voltage XH2576	$0.5\text{A} \leq I_{LOAD} \leq 3\text{A}$ , $15\text{V} \leq V_{IN} \leq 40\text{V}$ Circuit of Figure 21 and Figure 22 and	12	11.52/ <b>11.40</b> 12.48/ <b>12.60</b>	V V(Min) V(Max)
$V_{OUT}$	Output Voltage	$0.5\text{A} \leq I_{LOAD} \leq 3\text{A}$ , $15\text{V} \leq V_{IN} \leq 60\text{V}$ Circuit of Figure 21 and Figure 22	12	11.52/ <b>11.40</b> 12.54/ <b>12.66</b>	V V(Min) V(Max)
$\eta$	Efficiency	$V_{IN} = 15\text{V}$ , $I_{LOAD} = 3\text{A}$	88		%

- (1) All limits specified at room temperature (standard type face) and at temperature extremes (bold type face). All room temperature limits are 100% production tested. All limits at temperature extremes are specified via correlation using standard Statistical Quality Control (SQC) methods.
- (2) External components such as the catch diode, inductor, input and output capacitors can affect switching regulator system performance. When the XH2576 is used as shown in Figure 21 and Figure 22, system performance will be as shown in ELECTRICAL CHARACTERISTICS ALL OUTPUT VOLTAGE VERSIONS.

## ELECTRICAL CHARACTERISTICS XH2576-ADJ

Specifications with standard type face are for  $T_J = 25^\circ\text{C}$ , and those with **boldface type** apply over full Operating Temperature Range.

Symbol	Parameter	Conditions	XH2576-ADJ		Units (Limits)
			Typ	Limit <sup>(1)</sup>	
<b>SYSTEM PARAMETERS Test Circuit Figure 21 and Figure 22<sup>(2)</sup></b>					
$V_{OUT}$	Feedback Voltage	$V_{IN} = 12\text{V}$ , $I_{LOAD} = 0.5\text{A}$ $V_{OUT} = 5\text{V}$ , Circuit of Figure 21 and Figure 22	1.230	1.217 1.243	V V(Min) V(Max)
$V_{OUT}$	Feedback Voltage XH2576	$0.5\text{A} \leq I_{LOAD} \leq 3\text{A}$ , $8\text{V} \leq V_{IN} \leq 40\text{V}$ $V_{OUT} = 5\text{V}$ , Circuit of Figure 21 and Figure 22	1.230	1.193/ <b>1.180</b> 1.267/ <b>1.280</b>	V V(Min) V(Max)
$V_{OUT}$	Feedback Voltage	$0.5\text{A} \leq I_{LOAD} \leq 3\text{A}$ , $8\text{V} \leq V_{IN} \leq 60\text{V}$ $V_{OUT} = 5\text{V}$ , Circuit of Figure 21 and Figure 22	1.230	1.193/ <b>1.180</b> 1.273/ <b>1.286</b>	V V(Min) V(Max)
$\eta$	Efficiency	$V_{IN} = 12\text{V}$ , $I_{LOAD} = 3\text{A}$ , $V_{OUT} = 5\text{V}$	77		%

- (1) All limits specified at room temperature (standard type face) and at temperature extremes (bold type face). All room temperature limits are 100% production tested. All limits at temperature extremes are specified via correlation using standard Statistical Quality Control (SQC) methods.
- (2) External components such as the catch diode, inductor, input and output capacitors can affect switching regulator system performance. When the XH2576 is used as shown in Figure 21 and Figure 22, system performance will be as shown in ELECTRICAL CHARACTERISTICS ALL OUTPUT VOLTAGE VERSIONS.

**TYPICAL PERFORMANCE CHARACTERISTICS**

(Circuit of Figure 21 and Figure 22)

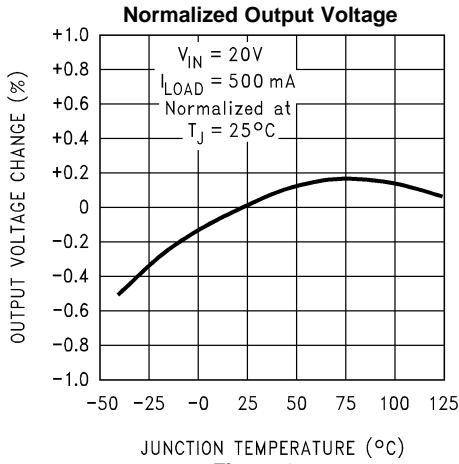

**Figure 2.**

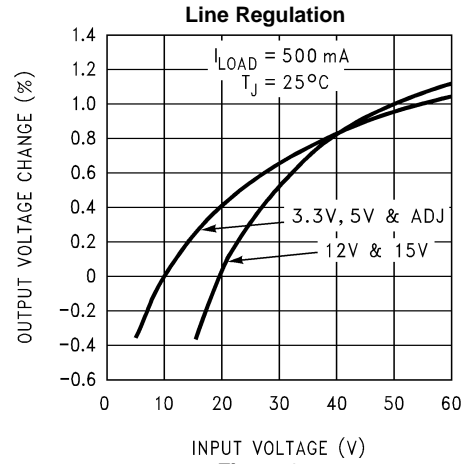

**Figure 3.**

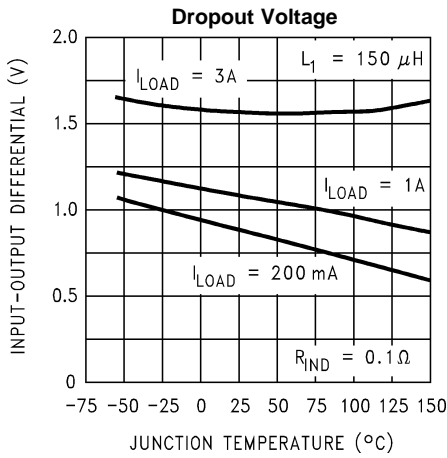

**Figure 4.**

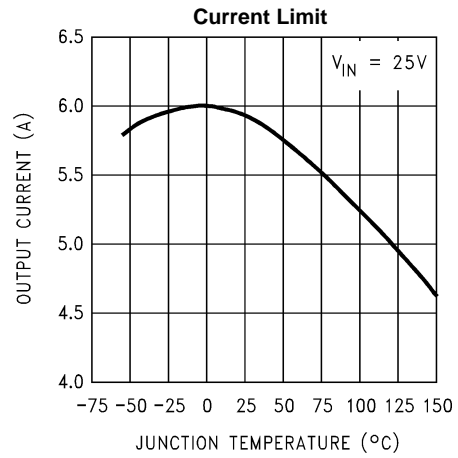

**Figure 5.**

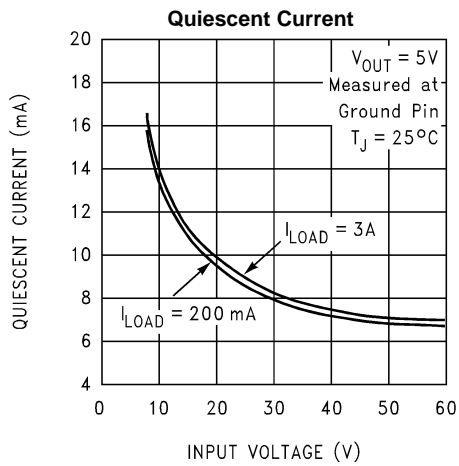

**Figure 6.**

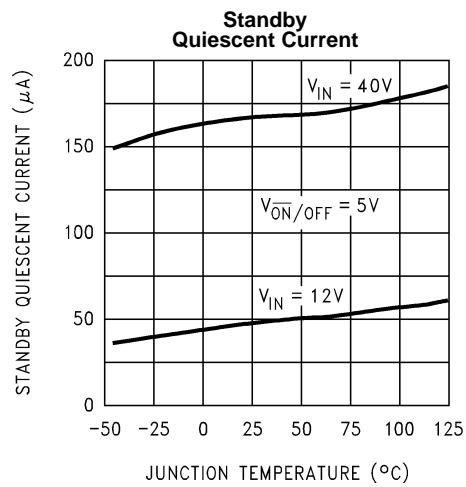

**Figure 7.**

**TYPICAL PERFORMANCE CHARACTERISTICS (continued)**

(Circuit of Figure 21 and Figure 22)

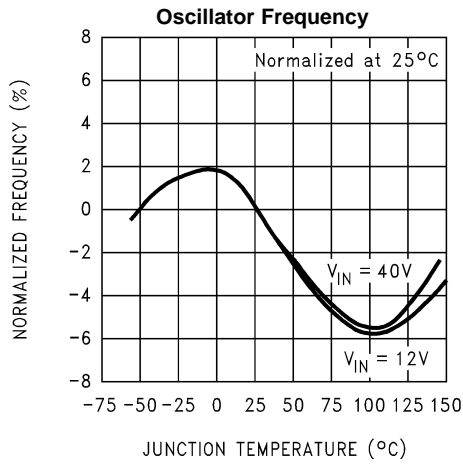

**Figure 8.**

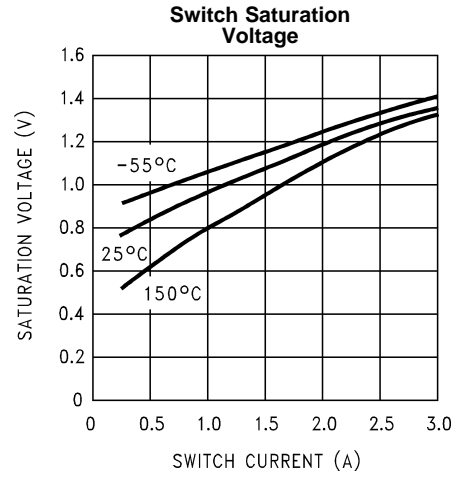

**Figure 9.**

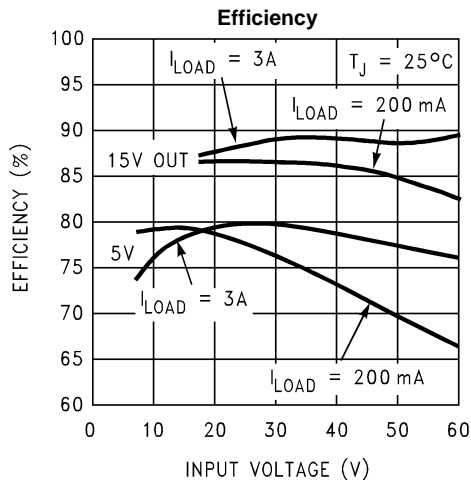

**Figure 10.**

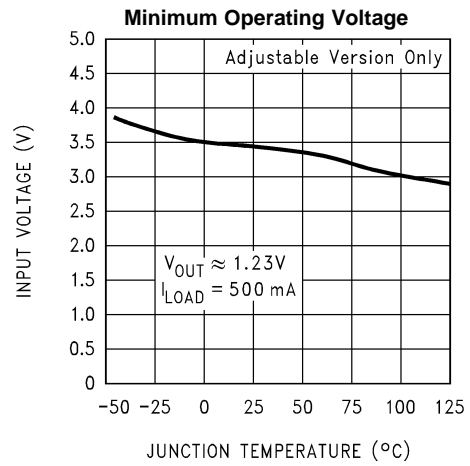

**Figure 11.**

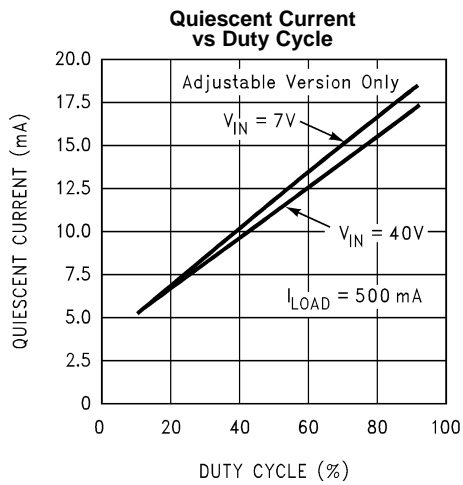

**Figure 12.**

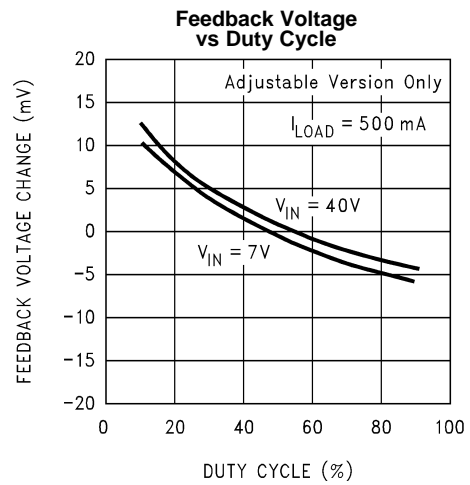

**Figure 13.**

**TYPICAL PERFORMANCE CHARACTERISTICS (continued)**

(Circuit of Figure 21 and Figure 22)

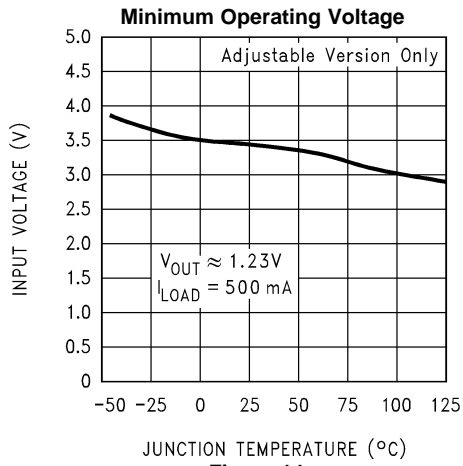

**Figure 14.**

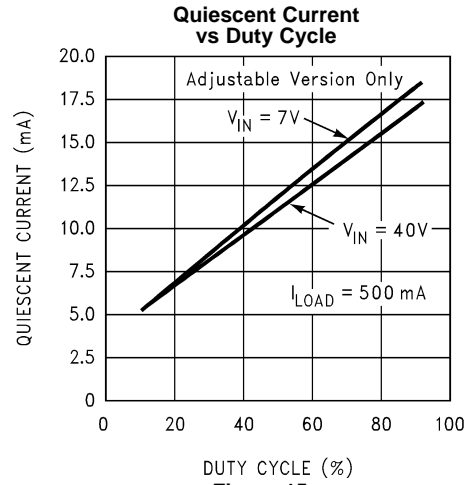

**Figure 15.**

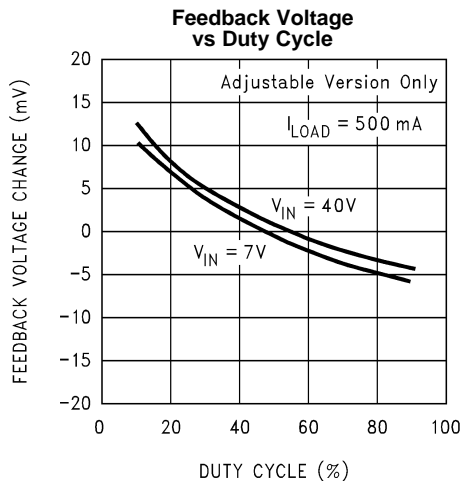

**Figure 16.**

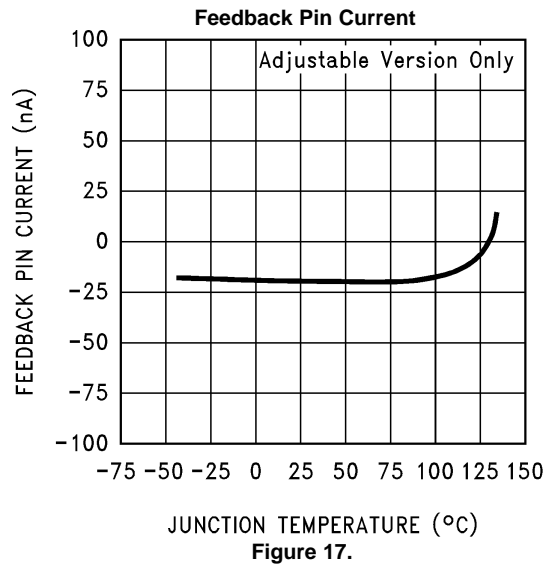

**Figure 17.**



**TYPICAL PERFORMANCE CHARACTERISTICS (continued)**

(Circuit of Figure 21 and Figure 22)

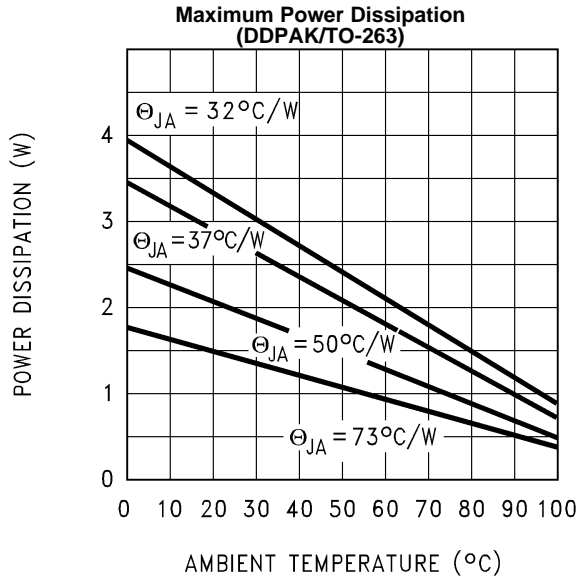
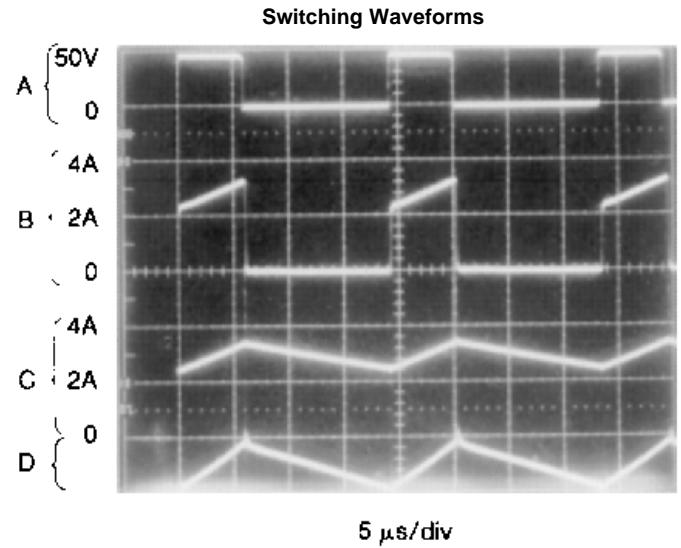

Figure 18.

If the DDPAK/TO-263 package is used, the thermal resistance can be reduced by increasing the PC board copper area thermally connected to the package. Using 0.5 square inches of copper area,  $\theta_{JA}$  is  $50^\circ\text{C/W}$ , with 1 square inch of copper area,  $\theta_{JA}$  is  $37^\circ\text{C/W}$ , and with 1.6 or more square inches of copper area,  $\theta_{JA}$  is  $32^\circ\text{C/W}$ .



$V_{OUT} = 15V$   
 A: Output Pin Voltage, 50V/div  
 B: Output Pin Current, 2A/div  
 C: Inductor Current, 2A/div  
 D: Output Ripple Voltage, 50 mV/div,  
 AC-Coupled  
 Horizontal Time Base: 5  $\mu\text{s/div}$

Figure 19.

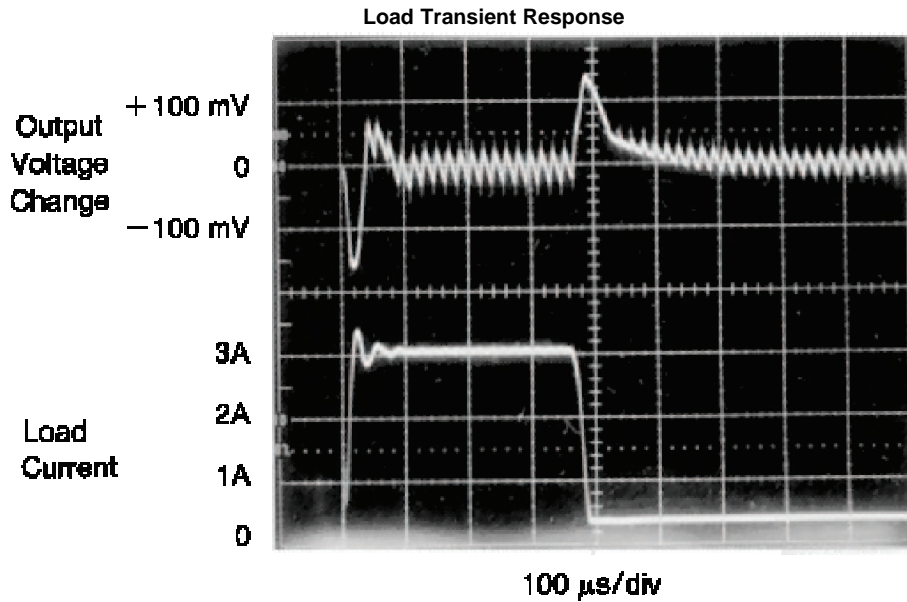

Figure 20.

## XH2576 Series Buck Regulator Design Procedure

PROCEDURE (Fixed Output Voltage Versions)	EXAMPLE (Fixed Output Voltage Versions)
<p><b>Given:</b>  <math>V_{OUT}</math> = Regulated Output Voltage            (3.3V, 5V, 12V, or 15V)  <math>V_{IN(Max)}</math> = Maximum Input Voltage  <math>I_{LOAD(Max)}</math> = Maximum Load Current</p>	<p><b>Given:</b>  <math>V_{OUT}</math> = 5V  <math>V_{IN(Max)}</math> = 15V  <math>I_{LOAD(Max)}</math> = 3A</p>
<p><b>1. Inductor Selection (L1)</b></p> <p><b>A.</b> Select the correct Inductor value selection guide from Figure 23, Figure 24, Figure 25, or Figure 26. (Output voltages of 3.3V, 5V, 12V or 15V respectively). For other output voltages, see the design procedure for the adjustable version.</p> <p><b>B.</b> From the inductor value selection guide, identify the inductance region intersected by <math>V_{IN(Max)}</math> and <math>I_{LOAD(Max)}</math>, and note the inductor code for that region.</p> <p><b>C.</b> Identify the inductor value from the inductor code, and select an appropriate inductor from the table shown in Figure 23. Part numbers are listed for three inductor manufacturers. The inductor chosen must be rated for operation at the XH2576 switching frequency (52 kHz) and for a current rating of <math>1.15 \times I_{LOAD}</math>. For additional inductor information, see INDUCTOR SELECTION.</p>	<p><b>1. Inductor Selection (L1)</b></p> <p><b>A.</b> Use the selection guide shown in Figure 24.</p> <p><b>B.</b> From the selection guide, the inductance area intersected by the 15V line and 3A line is L100.</p> <p><b>C.</b> Inductor value required is 100 <math>\mu</math>H. From the table in Figure 23. Choose AIE 415-0930, Pulse Engineering PE92108, or Renco RL2444.</p>
<p><b>2. Output Capacitor Selection (C<sub>OUT</sub>)</b></p> <p><b>A.</b> The value of the output capacitor together with the inductor defines the dominate pole-pair of the switching regulator loop. For stable operation and an acceptable output ripple voltage, (approximately 1% of the output voltage) a value between 100 <math>\mu</math>F and 470 <math>\mu</math>F is recommended.</p> <p><b>B.</b> The capacitor's voltage rating should be at least 1.5 times greater than the output voltage. For a 5V regulator, a rating of at least 8V is appropriate, and a 10V or 15V rating is recommended.</p> <p>Higher voltage electrolytic capacitors generally have lower ESR numbers, and for this reason it may be necessary to select a capacitor rated for a higher voltage than would normally be needed.</p>	<p><b>2. Output Capacitor Selection (C<sub>OUT</sub>)</b></p> <p><b>A.</b> C<sub>OUT</sub> = 680 <math>\mu</math>F to 2000 <math>\mu</math>F standard aluminum electrolytic.</p> <p><b>B.</b> Capacitor voltage rating = 20V.</p>
<p><b>3. Catch Diode Selection (D1)</b></p> <p><b>A.</b> The catch-diode current rating must be at least 1.2 times greater than the maximum load current. Also, if the power supply design must withstand a continuous output short, the diode should have a current rating equal to the maximum current limit of the XH2576. The most stressful condition for this diode is an overload or shorted output condition.</p> <p><b>B.</b> The reverse voltage rating of the diode should be at least 1.25 times the maximum input voltage.</p>	<p><b>3. Catch Diode Selection (D1)</b></p> <p><b>A.</b> For this example, a 3A current rating is adequate.</p> <p><b>B.</b> Use a 20V 1N5823 or SR302 Schottky diode, or any of the suggested fast-recovery diodes shown in Table 1.</p>
<p><b>4. Input Capacitor (C<sub>IN</sub>)</b></p> <p>An aluminum or tantalum electrolytic bypass capacitor located close to the regulator is needed for stable operation.</p>	<p><b>4. Input Capacitor (C<sub>IN</sub>)</b></p> <p>A 100 <math>\mu</math>F, 25V aluminum electrolytic capacitor located near the input and ground pins provides sufficient bypassing.</p>

**INDUCTOR VALUE SELECTION GUIDES**

(For Continuous Mode Operation)

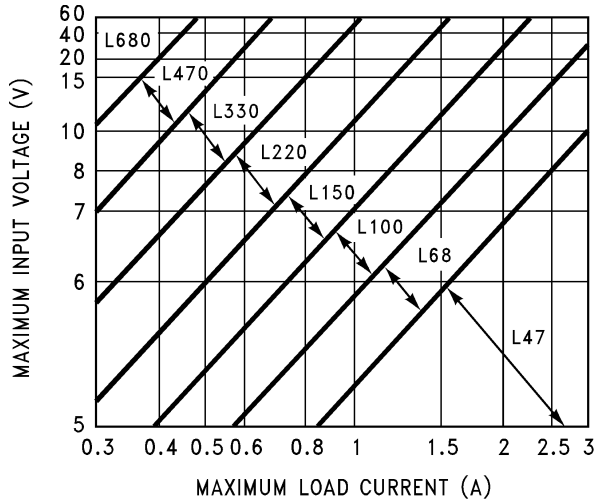

**Figure 23. XH2576-3.3**

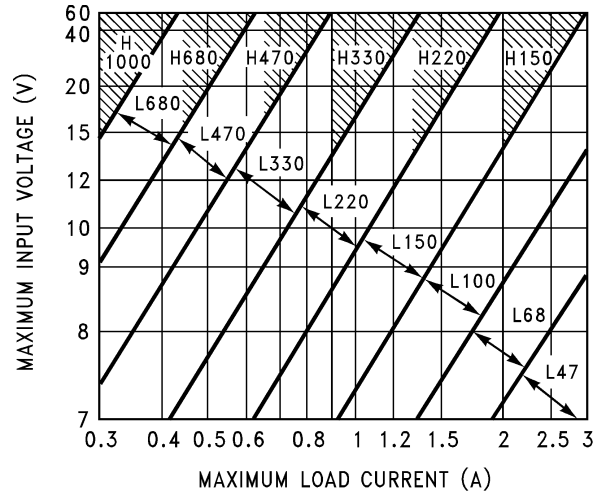

**Figure 24. XH2576-5.0**

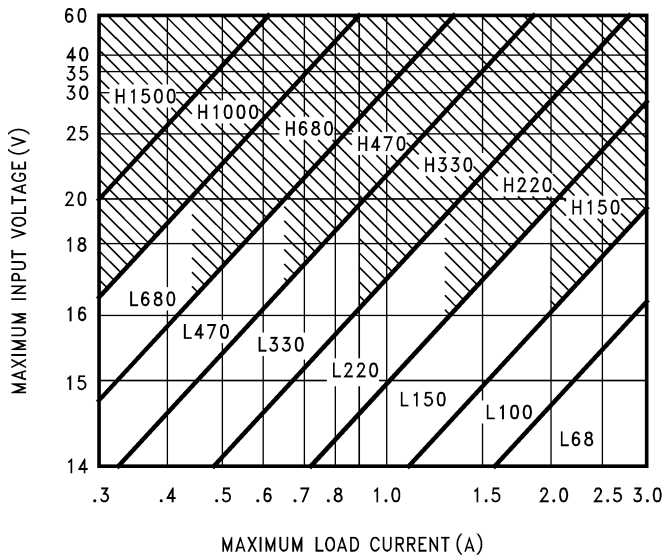

**Figure 25. XH2576-12**

(For Continuous Mode Operation)

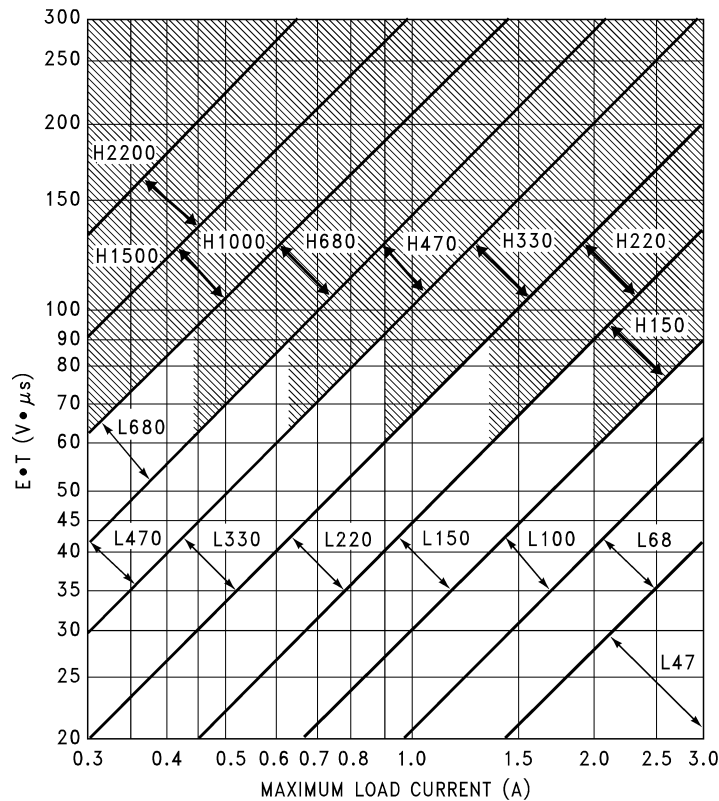
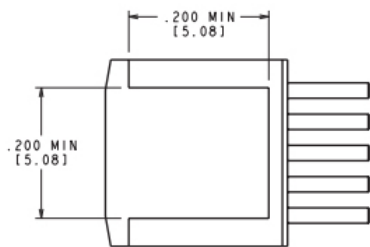
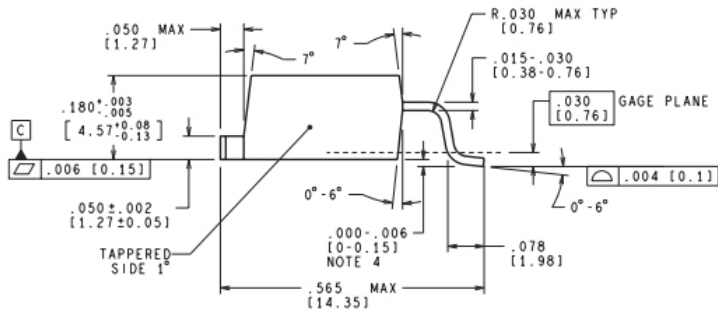
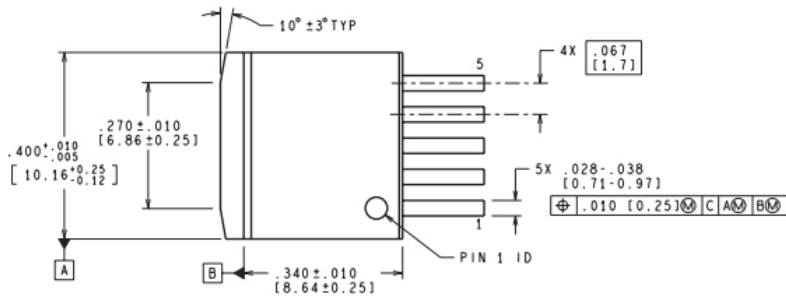

Figure 26. XH2576-ADJ

PROCEDURE (Adjustable Output Voltage Versions)	EXAMPLE (Adjustable Output Voltage Versions)
<p><b>Given:</b>  <math>V_{OUT}</math> = Regulated Output Voltage  <math>V_{IN(Max)}</math> = Maximum Input Voltage  <math>I_{LOAD(Max)}</math> = Maximum Load Current  <math>F</math> = Switching Frequency (Fixed at 52 kHz)</p>	<p><b>Given:</b>  <math>V_{OUT} = 10V</math>  <math>V_{IN(Max)} = 25V</math>  <math>I_{LOAD(Max)} = 3A</math>  <math>F = 52 \text{ kHz}</math></p>
<p><b>1. Programming Output Voltage</b> (Selecting <math>R_1</math> and <math>R_2</math>, as shown in Figure 21 and Figure 22)            Use the following formula to select the appropriate resistor values.</p> $V_{OUT} = V_{REF} \left( 1 + \frac{R_2}{R_1} \right) \quad \text{where } V_{REF} = 1.23V$ <p><math>R_1</math> can be between 1k and 5k. (For best temperature coefficient and stability with time, use 1% metal film resistors)</p> $R_2 = R_1 \left( \frac{V_{OUT}}{V_{REF}} - 1 \right)$	<p><b>1. Programming Output Voltage</b> (Selecting <math>R_1</math> and <math>R_2</math>)</p> $V_{OUT} = 1.23 \left( 1 + \frac{R_2}{R_1} \right) \quad \text{Select } R_1 = 1k$ $R_2 = R_1 \left( \frac{V_{OUT}}{V_{REF}} - 1 \right) = 1k \left( \frac{10V}{1.23V} - 1 \right)$ <p><math>R_2 = 1k (8.13 - 1) = 7.13k</math>, closest 1% value is 7.15k</p>

(For Continuous Mode Operation)

PROCEDURE (Adjustable Output Voltage Versions)	EXAMPLE (Adjustable Output Voltage Versions)
<p><b>2. Inductor Selection (L1)</b></p> <p>A. Calculate the inductor Volt • microsecond constant, E • T (V • μs), from the following formula:</p> $E \cdot T = (V_{IN} - V_{OUT}) \frac{V_{OUT}}{V_{IN}} \cdot \frac{1000}{F \text{ (in kHz)}} \text{ (V} \cdot \mu\text{s)}$ <p>B. Use the E • T value from the previous formula and match it with the E • T number on the vertical axis of the <b>Inductor Value Selection Guide</b> shown in Figure 26.</p> <p>C. On the horizontal axis, select the maximum load current.</p> <p>D. Identify the inductance region intersected by the E • T value and the maximum load current value, and note the inductor code for that region.</p> <p>E. Identify the inductor value from the inductor code, and select an appropriate inductor from the table shown in Table 2. Part numbers are listed for three inductor manufacturers. The inductor chosen must be rated for operation at the XH2576 switching frequency (52 kHz) and for a current rating of <math>1.15 \times I_{LOAD}</math>. For additional inductor information, see INDUCTOR SELECTION.</p>	<p><b>2. Inductor Selection (L1)</b></p> <p>A. Calculate E • T (V • μs)</p> $E \cdot T = (25 - 10) \cdot \frac{10}{25} \cdot \frac{1000}{52} = 115 \text{ V} \cdot \mu\text{s}$ <p>B. E • T = 115 V • μs</p> <p>C. <math>I_{LOAD(Max)} = 3\text{A}</math></p> <p>D. Inductance Region = H150</p> <p>E. Inductor Value = 150 μH <i>Choose from AIEpart #415-0936Pulse Engineering part #PE-531115, or Renco part #RL2445.</i></p>
<p><b>3. Output Capacitor Selection (C<sub>OUT</sub>)</b></p> <p>A. The value of the output capacitor together with the inductor defines the dominate pole-pair of the switching regulator loop. For stable operation, the capacitor must satisfy the following requirement:</p> $C_{OUT} \geq 13,300 \frac{V_{IN(Max)}}{V_{OUT} \cdot L(\mu\text{H})} \text{ (}\mu\text{F)}$ <p>The above formula yields capacitor values between 10 μF and 2200 μF that will satisfy the loop requirements for stable operation. But to achieve an acceptable output ripple voltage, (approximately 1% of the output voltage) and transient response, the output capacitor may need to be several times larger than the above formula yields.</p> <p>B. The capacitor's voltage rating should be at least 1.5 times greater than the output voltage. For a 10V regulator, a rating of at least 15V or more is recommended. Higher voltage electrolytic capacitors generally have lower ESR numbers, and for this reason it may be necessary to select a capacitor rate for a higher voltage than would normally be needed.</p>	<p><b>3. Output Capacitor Selection (C<sub>OUT</sub>)</b></p> $C_{OUT} > 13,300 \frac{25}{10 \cdot 150} = 22.2 \mu\text{F}$ <p>However, for acceptable output ripple voltage select</p> <p><math>C_{OUT} \geq 680 \mu\text{F}</math></p> <p><math>C_{OUT} = 680 \mu\text{F}</math> electrolytic capacitor</p>
<p><b>4. Catch Diode Selection (D1)</b></p> <p>A. The catch-diode current rating must be at least 1.2 times greater than the maximum load current. Also, if the power supply design must withstand a continuous output short, the diode should have a current rating equal to the maximum current limit of the XH2576 The most stressful condition for this diode is an overload or shorted output. See Table 1.</p> <p>B. The reverse voltage rating of the diode should be at least 1.25 times the maximum input voltage.</p>	<p><b>4. Catch Diode Selection (D1)</b></p> <p>A. For this example, a 3.3A current rating is adequate.</p> <p>B. Use a 30V 31DQ03 Schottky diode, or any of the suggested fast-recovery diodes in Table 1.</p>
<p><b>5. Input Capacitor (C<sub>IN</sub>)</b></p> <p>An aluminum or tantalum electrolytic bypass capacitor located close to the regulator is needed for stable operation.</p>	<p><b>5. Input Capacitor (C<sub>IN</sub>)</b></p> <p>A 100 μF aluminum electrolytic capacitor located near the input and ground pins provides sufficient bypassing.</p>



BOTTOM SIDE OF PACKAGE

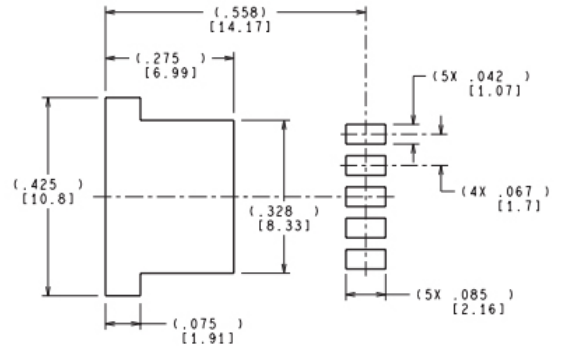

LAND PATTERN RECOMMENDATION

以上信息仅供参考. 如需帮助联系客服人员。谢谢 XINLUDA

## X-ON Electronics

Largest Supplier of Electrical and Electronic Components

*Click to view similar products for [Switching Controllers](#) category:*

*Click to view products by [XINLUDA](#) manufacturer:*

Other Similar products are found below :

[LV5065VB-TLM-H](#) [LV5066V-TLM-H](#) [LV5725JAZ-AH](#) [633888R](#) [MP2908AGF](#) [AZ7500EP-E1](#) [NCP1012AP133G](#) [NCP1217P133G](#)  
[NCP1218AD65R2G](#) [NCP1234AD100R2G](#) [NCP1244BD065R2G](#) [NCP1336ADR2G](#) [NCP1587GDR2G](#) [NCP6153MNTWG](#)  
[NCP81005MNTWG](#) [NCP81101BMNTXG](#) [NCP81205MNTXG](#) [HV9123NG-G-M934](#) [IR35207MTRPBF](#) [ISL6367HIRZ](#) [CAT874-80ULGT3](#)  
[SJ6522AG](#) [SJE6600](#) [TLE63893GV50XUMA1](#) [IR35215MTRPBF](#) [SG3845DM](#) [NCP1216P133G](#) [NCP1236DD65R2G](#) [NCP1247BD100R2G](#)  
[NCP1250BP65G](#) [NCP4202MNR2G](#) [NCP4204MNTXG](#) [NCP6132AMNR2G](#) [NCP81141MNTXG](#) [NCP81142MNTXG](#) [NCP81172MNTXG](#)  
[NCP81203MNTXG](#) [NCP81206MNTXG](#) [NX2155HCUPTR](#) [UC3845ADM](#) [UBA2051C](#) [IR35201MTRPBF](#) [MAX8778ETJ+](#)  
[MAX17500AAUB+T](#) [MAX17411GTM+T](#) [MAX16933ATIR/V+](#) [NCP1010AP130G](#) [NCP1063AD100R2G](#) [NCP1216AP133G](#)  
[NCP1217AP100G](#)