

FEATURES

- 3.3V,5V,12V,ADJ and Adjustable Output Versions
- Adjustable Version Output Voltage Range, 1.2V to 37V $\pm 4\%$ Max Over Line and Load Conditions
- Ensured 3A Output Load Current
- Input Voltage Range Up to 40V
- Requires Only 4 External Components
- Excellent Line and Load Regulation Specifications
- 150 kHz Fixed Frequency Internal Oscillator
- TTL Shutdown Capability
- Low Power Standby Mode, I_Q Typically 80 μA
- High Efficiency
- Uses Readily Available Standard Inductors
- Thermal Shutdown and Current Limit Protection

APPLICATIONS

- Simple High-Efficiency Step-Down (Buck) Regulator
- On-Card Switching Regulators
- Positive to Negative Converter

DESCRIPTION

The XH2596 series of regulators are monolithic integrated circuits that provide all the active functions for a step-down (buck) switching regulator, capable of driving a 3A load with excellent line and load regulation. These devices are available in fixed output voltages of 3.3V, 5V, 12V, and an adjustable output version.

Requiring a minimum number of external components, these regulators are simple to use and include internal frequency compensation, and a fixed-frequency oscillator.

The XH2596 series operates at a switching frequency of 150 kHz thus allowing smaller sized filter components than what would be needed with lower frequency switching regulators. Available in a different lead bend options, and a 5-lead TO-263 surface mount package.

A standard series of inductors are available from several different manufacturers optimized for use with the XH2596 series. This feature greatly simplifies the design of switch-mode power supplies.

Other features include a ensured $\pm 4\%$ tolerance on output voltage under specified input voltage and output load conditions, and $\pm 15\%$ on the oscillator frequency. External shutdown is included, featuring typically 80 μA standby current. Self protection features include a two stage frequency reducing current limit for the output switch and an over temperature shutdown for complete protection under fault conditions. ⁽¹⁾

Typical Application

(Fixed Output Voltage Versions)

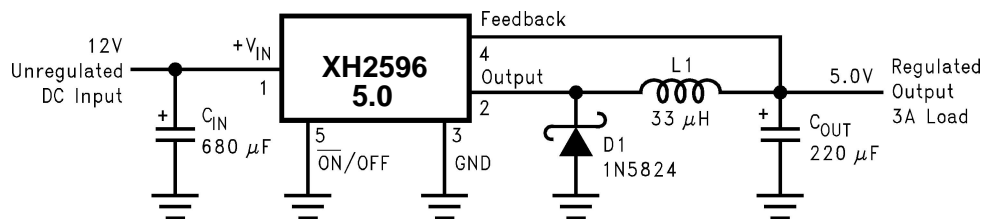

Connection Diagrams

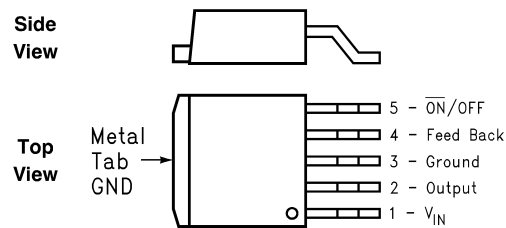

Figure 2. 5-Lead TO-263 (S) Package
See Package Number KTT0005B

Absolute Maximum Ratings ⁽¹⁾⁽²⁾

Maximum Supply Voltage	45V
ON/OFF Pin Input Voltage	$-0.3 \leq V \leq +25V$
Feedback Pin Voltage	$-0.3 \leq V \leq +25V$
Output Voltage to Ground (Steady State)	-1V
Power Dissipation	Internally limited
Storage Temperature Range	-65°C to $+150^{\circ}\text{C}$
ESD Susceptibility	
Human Body Model ⁽³⁾	2 kV
Lead Temperature	
DDPAK/TO-263 Package	
Vapor Phase (60 sec.)	$+215^{\circ}\text{C}$
Infrared (10 sec.)	$+245^{\circ}\text{C}$
Maximum Junction Temperature	$+150^{\circ}\text{C}$

- (1) Absolute Maximum Ratings indicate limits beyond which damage to the device may occur. Operating Ratings indicate conditions for which the device is intended to be functional, but do not ensure specific performance limits. For ensured specifications and test conditions, see the Electrical Characteristics.
- (2) The human body model is a 100 pF capacitor discharged through a 1.5k resistor into each pin.

Operating Conditions

Temperature Range	$-40^{\circ}\text{C} \leq T_J \leq +125^{\circ}\text{C}$
Supply Voltage	4.5V to 40V

XH2596-3.3 Electrical Characteristics

Specifications with standard type face are for $T_J = 25^\circ\text{C}$, and those with **boldface type** apply over **full Operating Temperature Range**

Symbol	Parameter	Conditions	XH2596-3.3		Units (Limits)
			Typ (1)	Limit (2)	
SYSTEM PARAMETERS ⁽³⁾ Test Circuit Figure 20					
V_{OUT}	Output Voltage	$4.75\text{V} \leq V_{IN} \leq 40\text{V}$, $0.2\text{A} \leq I_{LOAD} \leq 3\text{A}$	3.3	3.168/ 3.135 3.432/ 3.465	V V(min) V(max)
η	Efficiency	$V_{IN} = 12\text{V}$, $I_{LOAD} = 3\text{A}$	73		%

- (1) Typical numbers are at 25°C and represent the most likely norm.
- (2) All limits specified at room temperature (standard type face) and at temperature extremes (bold type face). All room temperature limits are 100% production tested. All limits at temperature extremes are ensured via correlation using standard Statistical Quality Control (SQC) methods. All limits are used to calculate Average Outgoing Quality Level (AOQL).
- (3) External components such as the catch diode, inductor, input and output capacitors, and voltage programming resistors can affect switching regulator system performance. When the XH2596 is used as shown in the Figure 20 test circuit, system performance will be as shown in system parameters of Electrical Characteristics section.

XH2596-5.0 Electrical Characteristics

Specifications with standard type face are for $T_J = 25^\circ\text{C}$, and those with **boldface type** apply over **full Operating Temperature Range**

Symbol	Parameter	Conditions	XH2596-5.0		Units (Limits)
			Typ (1)	Limit (2)	
SYSTEM PARAMETERS ⁽³⁾ Test Circuit Figure 20					
V_{OUT}	Output Voltage	$7\text{V} \leq V_{IN} \leq 40\text{V}$, $0.2\text{A} \leq I_{LOAD} \leq 3\text{A}$	5.0	4.800/ 4.750 5.200/ 5.250	V V(min) V(max)
η	Efficiency	$V_{IN} = 12\text{V}$, $I_{LOAD} = 3\text{A}$	80		%

- (1) Typical numbers are at 25°C and represent the most likely norm.
- (2) All limits specified at room temperature (standard type face) and at temperature extremes (bold type face). All room temperature limits are 100% production tested. All limits at temperature extremes are ensured via correlation using standard Statistical Quality Control (SQC) methods. All limits are used to calculate Average Outgoing Quality Level (AOQL).
- (3) External components such as the catch diode, inductor, input and output capacitors, and voltage programming resistors can affect switching regulator system performance. When the XH2596 is used as shown in the Figure 20 test circuit, system performance will be as shown in system parameters of Electrical Characteristics section.

XH2596-12 Electrical Characteristics

Specifications with standard type face are for $T_J = 25^\circ\text{C}$, and those with **boldface type** apply over **full Operating Temperature Range**

Symbol	Parameter	Conditions	XH2596-12		Units (Limits)
			Typ (1)	Limit (2)	
SYSTEM PARAMETERS ⁽³⁾ Test Circuit Figure 20					
V_{OUT}	Output Voltage	$15\text{V} \leq V_{IN} \leq 40\text{V}$, $0.2\text{A} \leq I_{LOAD} \leq 3\text{A}$	12.0	11.52/ 11.40 12.48/ 12.60	V V(min) V(max)
η	Efficiency	$V_{IN} = 25\text{V}$, $I_{LOAD} = 3\text{A}$	90		%

- (1) Typical numbers are at 25°C and represent the most likely norm.
- (2) All limits specified at room temperature (standard type face) and at temperature extremes (bold type face). All room temperature limits are 100% production tested. All limits at temperature extremes are ensured via correlation using standard Statistical Quality Control (SQC) methods. All limits are used to calculate Average Outgoing Quality Level (AOQL).
- (3) External components such as the catch diode, inductor, input and output capacitors, and voltage programming resistors can affect switching regulator system performance. When the XH2596 is used as shown in the Figure 20 test circuit, system performance will be as shown in system parameters of Electrical Characteristics section.

XH2596-ADJ Electrical Characteristics

Specifications with standard type face are for $T_J = 25^\circ\text{C}$, and those with **boldface type** apply over **full Operating Temperature Range**

Symbol	Parameter	Conditions	XH2596-ADJ		Units (Limits)
			Typ (1)	Limit (2)	
SYSTEM PARAMETERS (3) Test Circuit Figure 20					
V_{FB}	Feedback Voltage	$4.5\text{V} \leq V_{IN} \leq 40\text{V}$, $0.2\text{A} \leq I_{LOAD} \leq 3\text{A}$ V_{OUT} programmed for 3V. Circuit of Figure 20	1.230	1.193/ 1.180 1.267/ 1.280	V V(min) V(max)
η	Efficiency	$V_{IN} = 12\text{V}$, $V_{OUT} = 3\text{V}$, $I_{LOAD} = 3\text{A}$	73		%

- (1) Typical numbers are at 25°C and represent the most likely norm.
- (2) All limits specified at room temperature (standard type face) and at temperature extremes (bold type face). All room temperature limits are 100% production tested. All limits at temperature extremes are ensured via correlation using standard Statistical Quality Control (SQC) methods. All limits are used to calculate Average Outgoing Quality Level (AOQL).
- (3) External components such as the catch diode, inductor, input and output capacitors, and voltage programming resistors can affect switching regulator system performance. When the XH2596 is used as shown in the Figure 20 test circuit, system performance will be as shown in system parameters of Electrical Characteristics section.

All Output Voltage Versions Electrical Characteristics

Specifications with standard type face are for $T_J = 25^\circ\text{C}$, and those with **boldface type** apply over **full Operating Temperature Range**. Unless otherwise specified, $V_{IN} = 12\text{V}$ for the 3.3V, 5V, and Adjustable version and $V_{IN} = 24\text{V}$ for the 12V version. $I_{LOAD} = 500\text{mA}$

Symbol	Parameter	Conditions	XH2596-XX		Units (Limits)
			Typ (1)	Limit (2)	
DEVICE PARAMETERS					
I_b	Feedback Bias Current	Adjustable Version Only, $V_{FB} = 1.3\text{V}$	10	50/ 100	nA nA (max)
f_o	Oscillator Frequency	See (3)	150	127/ 110 173/ 173	kHz kHz(min) kHz(max)
V_{SAT}	Saturation Voltage	$I_{OUT} = 3\text{A}$ (4) (5)	1.16	1.4/ 1.5	V V(max)
DC	Max Duty Cycle (ON)	See (5)	100		%
	Min Duty Cycle (OFF)	See (6)	0		
I_{CL}	Current Limit	Peak Current (4)(5)	4.5	3.6/ 3.4 6.9/ 7.5	A A(min) A(max)
I_L	Output Leakage Current	Output = 0V (4)(6)		50	μA (max)
		Output = -1V (7)	2	30	mA mA(max)
I_Q	Quiescent Current	See (6)	5		mA
				10	mA(max)

- (1) Typical numbers are at 25°C and represent the most likely norm.
- (2) All limits specified at room temperature (standard type face) and at temperature extremes (bold type face). All room temperature limits are 100% production tested. All limits at temperature extremes are ensured via correlation using standard Statistical Quality Control (SQC) methods. All limits are used to calculate Average Outgoing Quality Level (AOQL).
- (3) The switching frequency is reduced when the second stage current limit is activated.
- (4) No diode, inductor or capacitor connected to output pin.
- (5) Feedback pin removed from output and connected to 0V to force the output transistor switch ON.
- (6) Feedback pin removed from output and connected to 12V for the 3.3V, 5V, and the ADJ. version, and 15V for the 12V version, to force the output transistor switch OFF.
- (7) $V_{IN} = 40\text{V}$.

All Output Voltage Versions Electrical Characteristics (continued)

Specifications with standard type face are for $T_J = 25^\circ\text{C}$, and those with **boldface type** apply over **full Operating Temperature Range**. Unless otherwise specified, $V_{IN} = 12\text{V}$ for the 3.3V, 5V, and Adjustable version and $V_{IN} = 24\text{V}$ for the 12V version. $I_{LOAD} = 500\text{ mA}$

Symbol	Parameter	Conditions	XH2596-XX		Units (Limits)
			Typ (1)	Limit (2)	
I_{STBY}	Standby Quiescent Current	ON/OFF pin = 5V (OFF) (7)	80	200/250	μA $\mu\text{A(max)}$
θ_{JC}	Thermal Resistance	TO-263 Package, Junction to Ambient (9)	2		$^\circ\text{C/W}$
θ_{JA}			50		$^\circ\text{C/W}$
θ_{JA}			50		$^\circ\text{C/W}$
θ_{JA}			30		$^\circ\text{C/W}$
θ_{JA}			20		$^\circ\text{C/W}$
ON/OFF CONTROL Test Circuit Figure 20					
V_{IH}	$\overline{\text{ON}}$ /OFF Pin Logic Input Threshold Voltage	Low (Regulator ON)	1.3	0.6	V V(max)
V_{IL}		High (Regulator OFF)		2.0	V(min)
I_H	$\overline{\text{ON}}$ /OFF Pin Input Current	$V_{LOGIC} = 2.5\text{V}$ (Regulator OFF)	5	15	μA $\mu\text{A(max)}$
I_L		$V_{LOGIC} = 0.5\text{V}$ (Regulator ON)	0.02	5	μA $\mu\text{A(max)}$

- (9) Junction to ambient thermal resistance with the TO-263 package tab soldered to a single printed circuit board with 0.5 in² of (1 oz.) copper area.
- (10) Junction to ambient thermal resistance with the TO-263 package tab soldered to a single sided printed circuit board with 2.5 in² of (1 oz.) copper area.
- (11) Junction to ambient thermal resistance with the TO-263 package tab soldered to a double sided printed circuit board with 3 in² of (1 oz.) copper area on the XH2596S side of the board, and approximately 16 in² of copper on the other side of the p-c board. See Application Information in this data sheet and the thermal model in Switchers Made Simple™ version 4.3 software.

Typical Performance Characteristics
(Circuit of Figure 20)

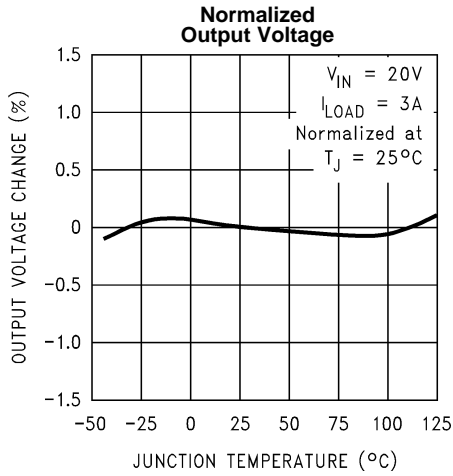

Figure 3.

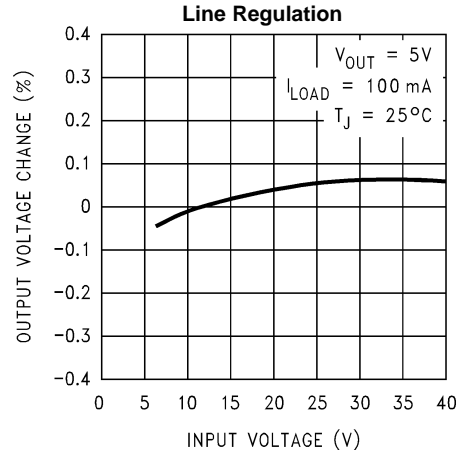

Figure 4.

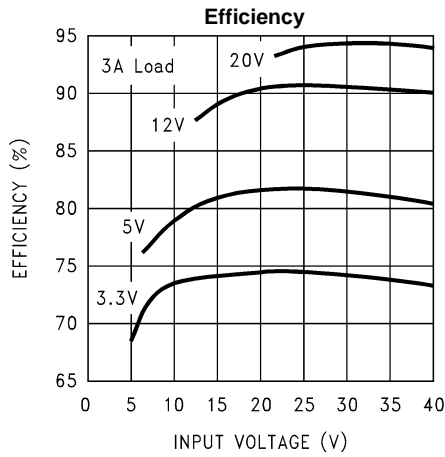

Figure 5.

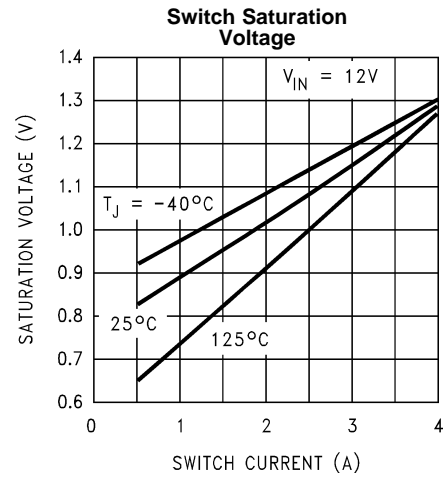

Figure 6.

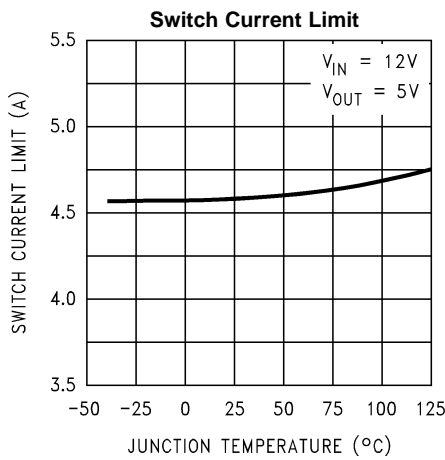

Figure 7.

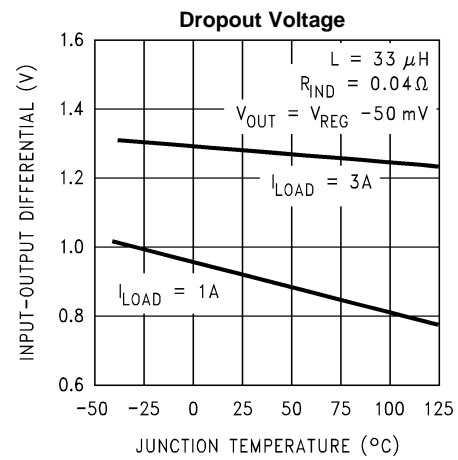

Figure 8.

Typical Performance Characteristics (continued)

(Circuit of Figure 20)

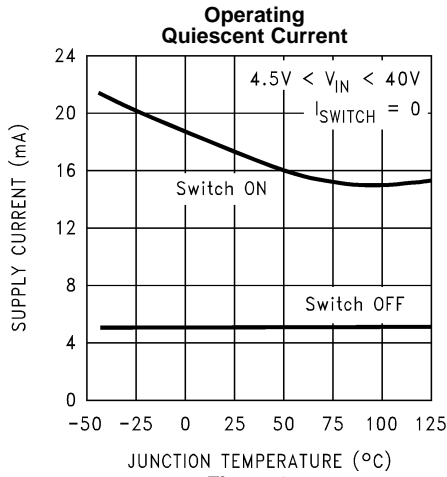

Figure 9.

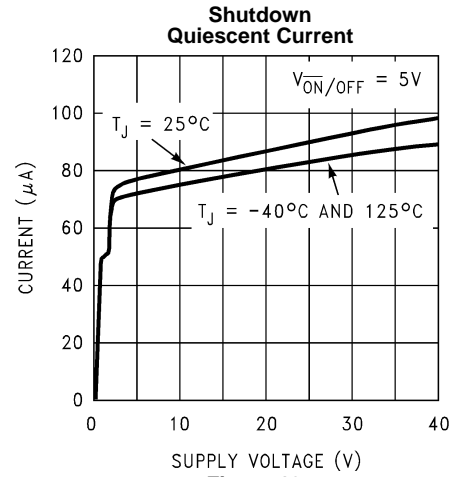

Figure 10.

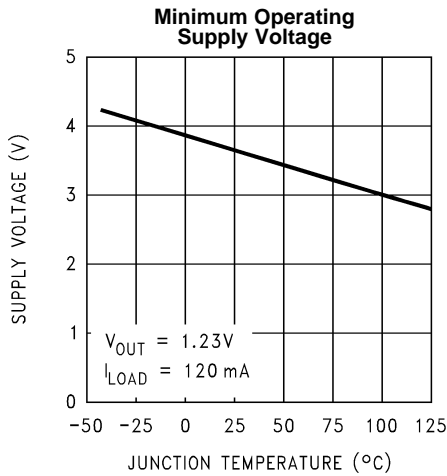

Figure 11.

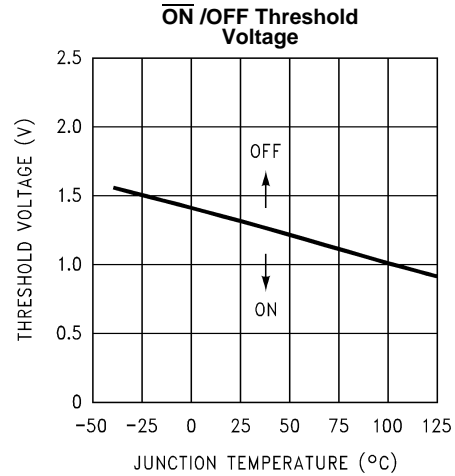

Figure 12.

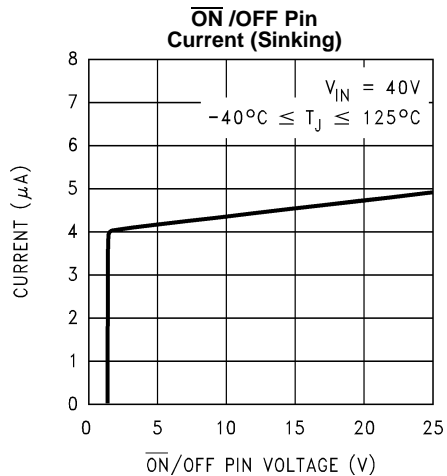

Figure 13.

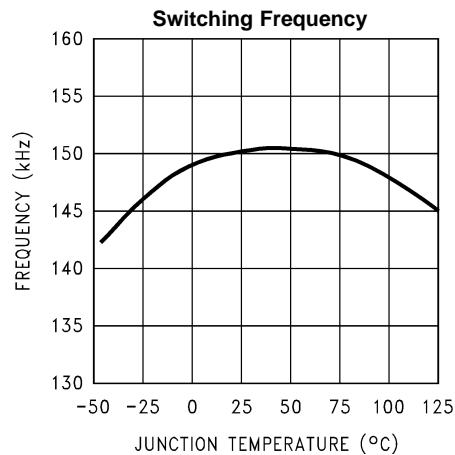

Figure 14.

Typical Performance Characteristics (continued)

(Circuit of Figure 20)

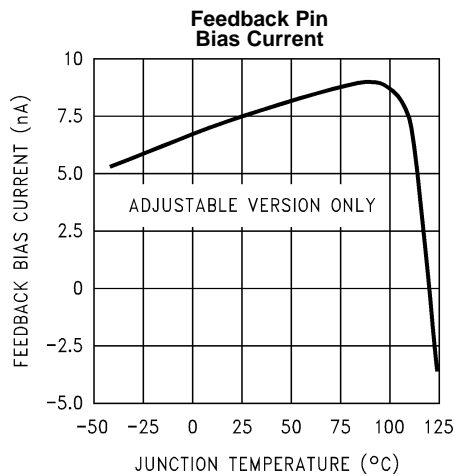
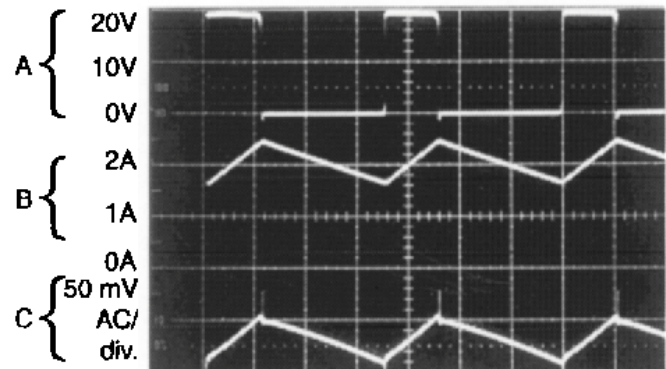

Figure 15.

Continuous Mode Switching Waveforms
 $V_{IN} = 20V, V_{OUT} = 5V, I_{LOAD} = 2A$
 $L = 32 \mu H, C_{OUT} = 220 \mu F, C_{OUT} ESR = 50 m\Omega$



A: Output Pin Voltage, 10V/div.
 B: Inductor Current 1A/div.
 C: Output Ripple Voltage, 50 mV/div.

Figure 16. Horizontal Time Base: 2 μs /div.

Discontinuous Mode Switching Waveforms
 $V_{IN} = 20V, V_{OUT} = 5V, I_{LOAD} = 500 mA$
 $L = 10 \mu H, C_{OUT} = 330 \mu F, C_{OUT} ESR = 45 m\Omega$

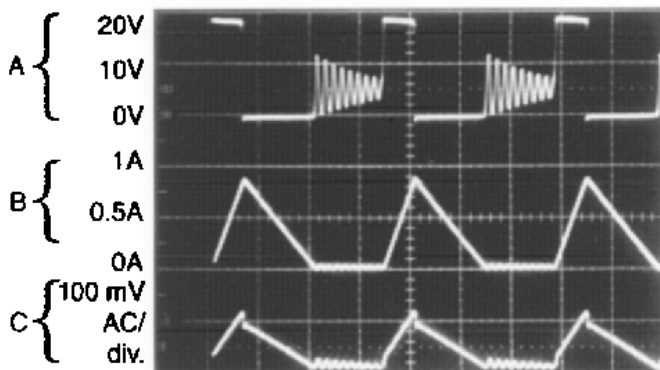

A: Output Pin Voltage, 10V/div.
 B: Inductor Current 0.5A/div.
 C: Output Ripple Voltage, 100 mV/div.

Figure 17. Horizontal Time Base: 2 μs /div.

Load Transient Response for Continuous Mode
 $V_{IN} = 20V, V_{OUT} = 5V, I_{LOAD} = 500 mA \text{ to } 2A$
 $L = 32 \mu H, C_{OUT} = 220 \mu F, C_{OUT} ESR = 50 m\Omega$

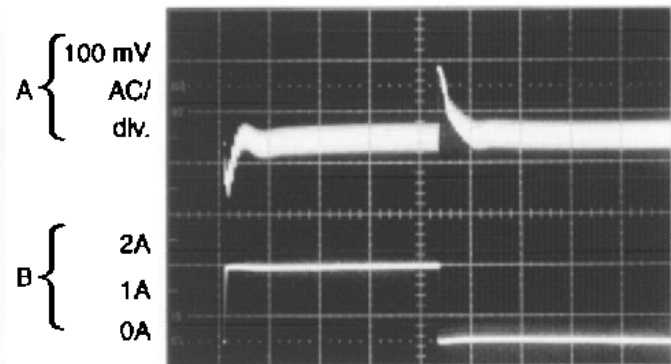

A: Output Voltage, 100 mV/div. (AC)
 B: 500 mA to 2A Load Pulse

Figure 18. Horizontal Time Base: 100 μs /div.

Load Transient Response for Discontinuous Mode
 $V_{IN} = 20V, V_{OUT} = 5V, I_{LOAD} = 500 mA \text{ to } 2A$
 $L = 10 \mu H, C_{OUT} = 330 \mu F, C_{OUT} ESR = 45 m\Omega$

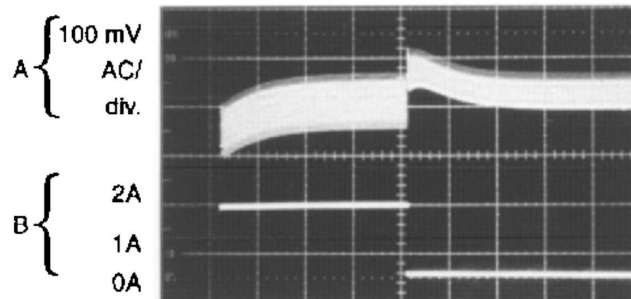

A: Output Voltage, 100 mV/div. (AC)
 B: 500 mA to 2A Load Pulse

Figure 19. Horizontal Time Base: 200 μs /div.

Test Circuit and Layout Guidelines

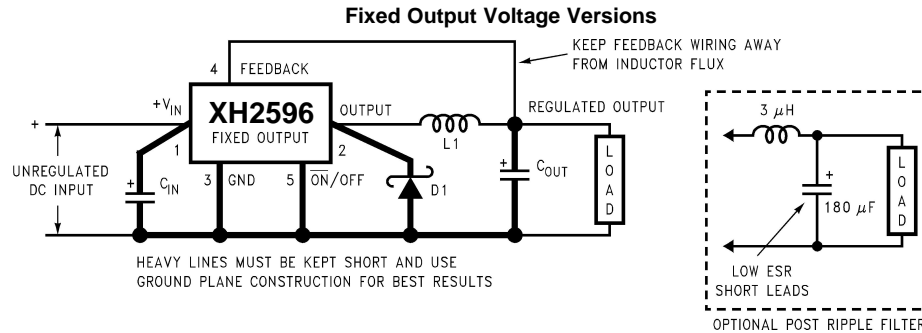

C_{IN} —470 μF , 50V, Aluminum Electrolytic Nichicon “PL Series”
 C_{OUT} —220 μF , 25V Aluminum Electrolytic, Nichicon “PL Series”
 $D1$ —5A, 40V Schottky Rectifier, 1N5825
 $L1$ —68 μH , L38

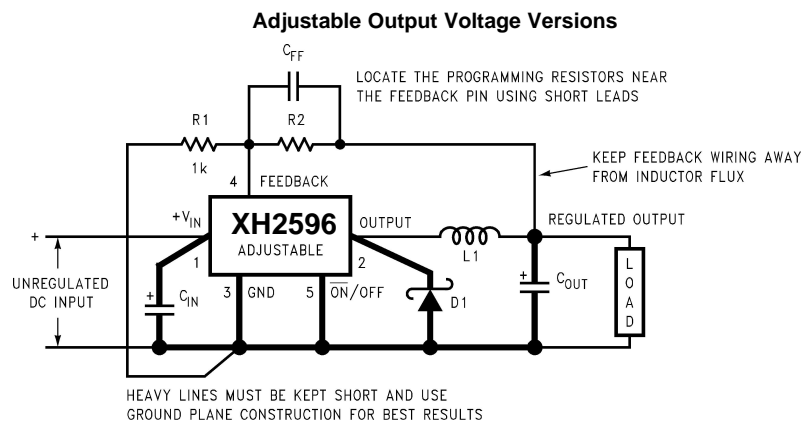

$$V_{OUT} = V_{REF} \left(1 + \frac{R_2}{R_1} \right)$$

where $V_{REF} = 1.23\text{V}$

$$R_2 = R_1 \left(\frac{V_{OUT}}{V_{REF}} - 1 \right)$$

Select R_1 to be approximately 1 k Ω , use a 1% resistor for best stability.

C_{IN} —470 μF , 50V, Aluminum Electrolytic Nichicon “PL Series”
 C_{OUT} —220 μF , 35V Aluminum Electrolytic, Nichicon “PL Series”
 $D1$ —5A, 40V Schottky Rectifier, 1N5825
 $L1$ —68 μH , L38
 $R1$ —1 k Ω , 1%
 C_{FF} —See Application Information Section

Figure 20. Standard Test Circuits and Layout Guides

As in any switching regulator, layout is very important. Rapidly switching currents associated with wiring inductance can generate voltage transients which can cause problems. For minimal inductance and ground loops, the wires indicated by **heavy lines** should be wide printed circuit traces and should be kept as short as possible. For best results, external components should be located as close to the switcher IC as possible using ground plane construction or single point grounding.

If **open core inductors are used**, special care must be taken as to the location and positioning of this type of inductor. Allowing the inductor flux to intersect sensitive feedback, IC groundpath and C_{OUT} wiring can cause problems.

When using the adjustable version, special care must be taken as to the location of the feedback resistors and the associated wiring. Physically locate both resistors near the IC, and route the wiring away from the inductor, especially an open core type of inductor. (See Application Information section for more information.)

XH2596 Series Buck Regulator Design Procedure (Fixed Output)

PROCEDURE (Fixed Output Voltage Version)	EXAMPLE (Fixed Output Voltage Version)
<p>Given: V_{OUT} = Regulated Output Voltage (3.3V, 5V or 12V) $V_{IN(max)}$ = Maximum DC Input Voltage $I_{LOAD(max)}$ = Maximum Load Current</p>	<p>Given: V_{OUT} = 5V $V_{IN(max)}$ = 12V $I_{LOAD(max)}$ = 3A</p>
<p>1. Inductor Selection (L1)</p> <p>A. Select the correct inductor value selection guide from Figures Figure 21, Figure 22, or Figure 23. (Output voltages of 3.3V, 5V, or 12V respectively.) For all other voltages, see the Design Procedure for the adjustable version.</p> <p>B. From the inductor value selection guide, identify the inductance region intersected by the Maximum Input Voltage line and the Maximum Load Current line. Each region is identified by an inductance value and an inductor code (LXX).</p> <p>C. Select an appropriate inductor from the four manufacturer's part numbers listed in Table 3.</p>	<p>1. Inductor Selection (L1)</p> <p>A. Use the inductor selection guide for the 5V version shown in Figure 22.</p> <p>B. From the inductor value selection guide shown in Figure 22, the inductance region intersected by the 12V horizontal line and the 3A vertical line is 33 μH, and the inductor code is L40.</p> <p>C. The inductance value required is 33 μH. From the table in Table 3, go to the L40 line and choose an inductor part number from any of the four manufacturers shown. (In most instance, both through hole and surface mount inductors are available.)</p>
<p>2. Output Capacitor Selection (C_{OUT})</p> <p>A. In the majority of applications, low ESR (Equivalent Series Resistance) electrolytic capacitors between 82 μF and 820 μF and low ESR solid tantalum capacitors between 10 μF and 470 μF provide the best results. This capacitor should be located close to the IC using short capacitor leads and short copper traces. Do not use capacitors larger than 820 μF .</p> <p>For additional information, see section on output capacitors in Application Information section.</p> <p>B. To simplify the capacitor selection procedure, refer to the quick design component selection table shown in Table 1. This table contains different input voltages, output voltages, and load currents, and lists various inductors and output capacitors that will provide the best design solutions.</p> <p>C. The capacitor voltage rating for electrolytic capacitors should be at least 1.5 times greater than the output voltage, and often much higher voltage ratings are needed to satisfy the low ESR requirements for low output ripple voltage.</p> <p>D. For computer aided design software, see Switchers Made Simple™ version 4.3 or later.</p>	<p>2. Output Capacitor Selection (C_{OUT})</p> <p>A. See section on output capacitors in Application Information section.</p> <p>B. From the quick design component selection table shown in Table 1, locate the 5V output voltage section. In the load current column, choose the load current line that is closest to the current needed in your application, for this example, use the 3A line. In the maximum input voltage column, select the line that covers the input voltage needed in your application, in this example, use the 15V line. Continuing on this line are recommended inductors and capacitors that will provide the best overall performance.</p> <p>The capacitor list contains both through hole electrolytic and surface mount tantalum capacitors from four different capacitor manufacturers. It is recommended that both the manufacturers and the manufacturer's series that are listed in the table be used.</p> <p>In this example aluminum electrolytic capacitors from several different manufacturers are available with the range of ESR numbers needed.</p> <p>330 μF 35V Panasonic HFQ Series 330 μF 35V Nichicon PL Series</p> <p>C. For a 5V output, a capacitor voltage rating at least 7.5V or more is needed. But even a low ESR, switching grade, 220 μF 10V aluminum electrolytic capacitor would exhibit approximately 225 mΩ of ESR (see the curve in Figure 26 for the ESR vs voltage rating). This amount of ESR would result in relatively high output ripple voltage. To reduce the ripple to 1% of the output voltage, or less, a capacitor with a higher value or with a higher voltage rating (lower ESR) should be selected. A 16V or 25V capacitor will reduce the ripple voltage by approximately half.</p>

PROCEDURE (Fixed Output Voltage Version)	EXAMPLE (Fixed Output Voltage Version)
<p>3. Catch Diode Selection (D1)</p> <p>A. The catch diode current rating must be at least 1.3 times greater than the maximum load current. Also, if the power supply design must withstand a continuous output short, the diode should have a current rating equal to the maximum current limit of the XH2596. The most stressful condition for this diode is an overload or shorted output condition.</p> <p>B. The reverse voltage rating of the diode should be at least 1.25 times the maximum input voltage.</p> <p>C. This diode must be fast (short reverse recovery time) and must be located close to the XH2596 using short leads and short printed circuit traces. Because of their fast switching speed and low forward voltage drop, Schottky diodes provide the best performance and efficiency, and should be the first choice, especially in low output voltage applications. Ultra-fast recovery, or High-Efficiency rectifiers also provide good results. Ultra-fast recovery diodes typically have reverse recovery times of 50 ns or less. Rectifiers such as the 1N5400 series are much too slow and should not be used.</p>	<p>3. Catch Diode Selection (D1)</p> <p>A. Refer to the table shown in Table 6. In this example, a 5A, 20V, 1N5823 Schottky diode will provide the best performance, and will not be overstressed even for a shorted output.</p>
<p>4. Input Capacitor (C_{IN})</p> <p>A low ESR aluminum or tantalum bypass capacitor is needed between the input pin and ground pin to prevent large voltage transients from appearing at the input. This capacitor should be located close to the IC using short leads. In addition, the RMS current rating of the input capacitor should be selected to be at least ½ the DC load current. The capacitor manufacturers data sheet must be checked to assure that this current rating is not exceeded. The curve shown in Figure 25 shows typical RMS current ratings for several different aluminum electrolytic capacitor values.</p> <p>For an aluminum electrolytic, the capacitor voltage rating should be approximately 1.5 times the maximum input voltage. Caution must be exercised if solid tantalum capacitors are used (see Application Information on input capacitor). The tantalum capacitor voltage rating should be 2 times the maximum input voltage and it is recommended that they be surge current tested by the manufacturer.</p> <p>Use caution when using ceramic capacitors for input bypassing, because it may cause severe ringing at the V_{IN} pin.</p> <p>For additional information, see section on input capacitors in Application Information section.</p>	<p>4. Input Capacitor (C_{IN})</p> <p>The important parameters for the Input capacitor are the input voltage rating and the RMS current rating. With a nominal input voltage of 12V, an aluminum electrolytic capacitor with a voltage rating greater than 18V (1.5 × V_{IN}) would be needed. The next higher capacitor voltage rating is 25V.</p> <p>The RMS current rating requirement for the input capacitor in a buck regulator is approximately ½ the DC load current. In this example, with a 3A load, a capacitor with a RMS current rating of at least 1.5A is needed. The curves shown in Figure 25 can be used to select an appropriate input capacitor. From the curves, locate the 35V line and note which capacitor values have RMS current ratings greater than 1.5A. A 680 µF/35V capacitor could be used.</p> <p>For a through hole design, a 680 µF/35V electrolytic capacitor (Panasonic HFQ series or Nichicon PL series or equivalent) would be adequate. Other types or other manufacturers capacitors can be used provided the RMS ripple current ratings are adequate.</p> <p>For surface mount designs, solid tantalum capacitors can be used, but caution must be exercised with regard to the capacitor surge current rating (see Application Information on input capacitors in this data sheet). The TPS series available from AVX, and the 593D series from Sprague are both surge current tested.</p>

Table 1. XH2596 Fixed Voltage Quick Design Component Selection Table

Conditions			Inductor		Output Capacitor			
					Through Hole Electrolytic		Surface Mount Tantalum	
Output Voltage (V)	Load Current (A)	Max Input Voltage (V)	Inductance (µH)	Inductor (#)	Panasonic HFQ Series (µF/V)	Nichicon PL Series (µF/V)	AVX TPS Series (µF/V)	Sprague 595D Series (µF/V)
3.3	3	5	22	L41	470/25	560/16	330/6.3	390/6.3
		7	22	L41	560/35	560/35	330/6.3	390/6.3
		10	22	L41	680/35	680/35	330/6.3	390/6.3
		40	33	L40	560/35	470/35	330/6.3	390/6.3
	6	22	L33	470/25	470/35	330/6.3	390/6.3	
	2	10	33	L32	330/35	330/35	330/6.3	390/6.3
		40	47	L39	330/35	270/50	220/10	330/10

Table 1. XH2596 Fixed Voltage Quick Design Component Selection Table (continued)

Conditions			Inductor		Output Capacitor			
Output Voltage (V)	Load Current (A)	Max Input Voltage (V)	Inductance (μH)	Inductor (#)	Through Hole Electrolytic		Surface Mount Tantalum	
					Panasonic HFQ Series (μF/V)	Nichicon PL Series (μF/V)	AVX TPS Series (μF/V)	Sprague 595D Series (μF/V)
5	3	8	22	L41	470/25	560/16	220/10	330/10
		10	22	L41	560/25	560/25	220/10	330/10
		15	33	L40	330/35	330/35	220/10	330/10
		40	47	L39	330/35	270/35	220/10	330/10
	2	9	22	L33	470/25	560/16	220/10	330/10
		20	68	L38	180/35	180/35	100/10	270/10
		40	68	L38	180/35	180/35	100/10	270/10
12	3	15	22	L41	470/25	470/25	100/16	180/16
		18	33	L40	330/25	330/25	100/16	180/16
		30	68	L44	180/25	180/25	100/16	120/20
		40	68	L44	180/35	180/35	100/16	120/20
	2	15	33	L32	330/25	330/25	100/16	180/16
		20	68	L38	180/25	180/25	100/16	120/20
		40	150	L42	82/25	82/25	68/20	68/25

XH2596 Series Buck Regulator Design Procedure (Adjustable Output)

PROCEDURE (Adjustable Output Voltage Version)	EXAMPLE (Adjustable Output Voltage Version)
<p>Given: V_{OUT} = Regulated Output Voltage $V_{IN(max)}$ = Maximum Input Voltage $I_{LOAD(max)}$ = Maximum Load Current F = Switching Frequency (Fixed at a nominal 150 kHz).</p>	<p>Given: V_{OUT} = 20V $V_{IN(max)}$ = 28V $I_{LOAD(max)}$ = 3A F = Switching Frequency (Fixed at a nominal 150 kHz).</p>
<p>1. Programming Output Voltage (Selecting R_1 and R_2, as shown in Figure 20) Use the following formula to select the appropriate resistor values.</p> $V_{OUT} = V_{REF} \left(1 + \frac{R_2}{R_1} \right) \text{ where } V_{REF} = 1.23V \quad (1)$ <p>Select a value for R_1 between 240Ω and 1.5 kΩ. The lower resistor values minimize noise pickup in the sensitive feedback pin. (For the lowest temperature coefficient and the best stability with time, use 1% metal film resistors.)</p> $R_2 = R_1 \left(\frac{V_{OUT}}{V_{REF}} - 1 \right) \quad (2)$	<p>1. Programming Output Voltage (Selecting R_1 and R_2, as shown in Figure 20) Select R_1 to be 1 kΩ, 1%. Solve for R_2.</p> $R_2 = R_1 \left(\frac{V_{OUT}}{V_{REF}} - 1 \right) = 1k \left(\frac{20V}{1.23V} - 1 \right) \quad (3)$ <p>$R_2 = 1k (16.26 - 1) = 15.26k$, closest 1% value is 15.4 kΩ. $R_2 = 15.4 kΩ$.</p>

PROCEDURE (Adjustable Output Voltage Version)	EXAMPLE (Adjustable Output Voltage Version)
<p>2. Inductor Selection (L1)</p> <p>A. Calculate the inductor Volt • microsecond constant $E \cdot T$ ($V \cdot \mu s$), from the following formula:</p> $E \cdot T = (V_{IN} - V_{OUT} - V_{SAT}) \cdot \frac{V_{OUT} + V_D}{V_{IN} - V_{SAT} + V_D} \cdot \frac{1000}{150 \text{ kHz}} (V \cdot \mu s)$ <p>where</p> <ul style="list-style-type: none"> • V_{SAT} = internal switch saturation voltage = 1.16V • V_D = diode forward voltage drop = 0.5V <p style="text-align: right;">(4)</p> <p>B. Use the $E \cdot T$ value from the previous formula and match it with the $E \cdot T$ number on the vertical axis of the Inductor Value Selection Guide shown in Figure 24.</p> <p>C. on the horizontal axis, select the maximum load current.</p> <p>D. Identify the inductance region intersected by the $E \cdot T$ value and the Maximum Load Current value. Each region is identified by an inductance value and an inductor code (LXX).</p> <p>E. Select an appropriate inductor from the four manufacturer's part numbers listed in Table 3.</p>	<p>2. Inductor Selection (L1)</p> <p>A. Calculate the inductor Volt • microsecond constant ($E \cdot T$),</p> $E \cdot T = (28 - 20 - 1.16) \cdot \frac{20 + 0.5}{28 - 1.16 + 0.5} \cdot \frac{1000}{150} (V \cdot \mu s)$ $E \cdot T = (6.84) \cdot \frac{20.5}{27.34} \cdot 6.67 (V \cdot \mu s) = 34.2 (V \cdot \mu s)$ <p style="text-align: right;">(5)</p> <p>B. $E \cdot T = 34.2 (V \cdot \mu s)$</p> <p>C. $I_{LOAD(max)} = 3A$</p> <p>D. From the inductor value selection guide shown in Figure 24, the inductance region intersected by the 34 ($V \cdot \mu s$) horizontal line and the 3A vertical line is 47 μH, and the inductor code is L39.</p> <p>E. From the table in <i>Table 3</i>, locate line L39, and select an inductor part number from the list of manufacturers part numbers.</p>
<p>3. Output Capacitor Selection (C_{OUT})</p> <p>A. In the majority of applications, low ESR electrolytic or solid tantalum capacitors between 82 μF and 820 μF provide the best results. This capacitor should be located close to the IC using short capacitor leads and short copper traces. Do not use capacitors larger than 820 μF. For additional information, see section on output capacitors in Application Information section.</p> <p>B. To simplify the capacitor selection procedure, refer to the quick design table shown in Table 2. This table contains different output voltages, and lists various output capacitors that will provide the best design solutions.</p> <p>C. The capacitor voltage rating should be at least 1.5 times greater than the output voltage, and often much higher voltage ratings are needed to satisfy the low ESR requirements needed for low output ripple voltage.</p>	<p>3. Output Capacitor Selection (C_{OUT})</p> <p>A. See section on C_{OUT} in Application Information section.</p> <p>B. From the quick design table shown in Table 2, locate the output voltage column. From that column, locate the output voltage closest to the output voltage in your application. In this example, select the 24V line. Under the OUTPUT CAPACITOR section, select a capacitor from the list of through hole electrolytic or surface mount tantalum types from four different capacitor manufacturers. It is recommended that both the manufacturers and the manufacturers series that are listed in the table be used.</p> <p>In this example, through hole aluminum electrolytic capacitors from several different manufacturers are available.</p> <p style="padding-left: 40px;">220 μF/35V Panasonic HFQ Series</p> <p style="padding-left: 40px;">150 μF/35V Nichicon PL Series</p> <p>C. For a 20V output, a capacitor rating of at least 30V or more is needed. In this example, either a 35V or 50V capacitor would work. A 35V rating was chosen, although a 50V rating could also be used if a lower output ripple voltage is needed.</p> <p>Other manufacturers or other types of capacitors may also be used, provided the capacitor specifications (especially the 100 kHz ESR) closely match the types listed in the table. Refer to the capacitor manufacturers data sheet for this information.</p>
<p>4. Feedforward Capacitor (C_{FF}) (See Figure 20)</p> <p>For output voltages greater than approximately 10V, an additional capacitor is required. The compensation capacitor is typically between 100 pF and 33 nF, and is wired in parallel with the output voltage setting resistor, R_2. It provides additional stability for high output voltages, low input-output voltages, and/or very low ESR output capacitors, such as solid tantalum capacitors.</p> $C_{FF} = \frac{1}{31 \times 10^3 \times R_2}$ <p style="text-align: right;">(6)</p> <p>This capacitor type can be ceramic, plastic, silver mica, etc. (Because of the unstable characteristics of ceramic capacitors made with Z5U material, they are not recommended.)</p>	<p>4. Feedforward Capacitor (C_{FF})</p> <p>The table shown in Table 2 contains feed forward capacitor values for various output voltages. In this example, a 560 pF capacitor is needed.</p>

PROCEDURE (Adjustable Output Voltage Version)	EXAMPLE (Adjustable Output Voltage Version)
<p>5. Catch Diode Selection (D1)</p> <p>A. The catch diode current rating must be at least 1.3 times greater than the maximum load current. Also, if the power supply design must withstand a continuous output short, the diode should have a current rating equal to the maximum current limit of the XH2596. The most stressful condition for this diode is an overload or shorted output condition.</p> <p>B. The reverse voltage rating of the diode should be at least 1.25 times the maximum input voltage.</p> <p>C. This diode must be fast (short reverse recovery time) and must be located close to the XH2596 using short leads and short printed circuit traces. Because of their fast switching speed and low forward voltage drop, Schottky diodes provide the best performance and efficiency, and should be the first choice, especially in low output voltage applications. Ultra-fast recovery, or High-Efficiency rectifiers are also a good choice, but some types with an abrupt turn-off characteristic may cause instability or EMI problems. Ultra-fast recovery diodes typically have reverse recovery times of 50 ns or less. Rectifiers such as the 1N4001 series are much too slow and should not be used.</p>	<p>5. Catch Diode Selection (D1)</p> <p>A. Refer to the table shown in Table 6. Schottky diodes provide the best performance, and in this example a 5A, 40V, 1N5825 Schottky diode would be a good choice. The 5A diode rating is more than adequate and will not be overstressed even for a shorted output.</p>
<p>6. Input Capacitor (C_{IN})</p> <p>A low ESR aluminum or tantalum bypass capacitor is needed between the input pin and ground to prevent large voltage transients from appearing at the input. In addition, the RMS current rating of the input capacitor should be selected to be at least ½ the DC load current. The capacitor manufacturers data sheet must be checked to assure that this current rating is not exceeded. The curve shown in Figure 25 shows typical RMS current ratings for several different aluminum electrolytic capacitor values.</p> <p>This capacitor should be located close to the IC using short leads and the voltage rating should be approximately 1.5 times the maximum input voltage.</p> <p>If solid tantalum input capacitors are used, it is recommended that they be surge current tested by the manufacturer.</p> <p>Use caution when using a high dielectric constant ceramic capacitor for input bypassing, because it may cause severe ringing at the V_{IN} pin.</p> <p>For additional information, see section on input capacitors in Application Information section.</p>	<p>6. Input Capacitor (C_{IN})</p> <p>The important parameters for the Input capacitor are the input voltage rating and the RMS current rating. With a nominal input voltage of 28V, an aluminum electrolytic aluminum electrolytic capacitor with a voltage rating greater than 42V (1.5 × V_{IN}) would be needed. Since the the next higher capacitor voltage rating is 50V, a 50V capacitor should be used. The capacitor voltage rating of (1.5 × V_{IN}) is a conservative guideline, and can be modified somewhat if desired.</p> <p>The RMS current rating requirement for the input capacitor of a buck regulator is approximately ½ the DC load current. In this example, with a 3A load, a capacitor with a RMS current rating of at least 1.5A is needed.</p> <p>The curves shown in Figure 25 can be used to select an appropriate input capacitor. From the curves, locate the 50V line and note which capacitor values have RMS current ratings greater than 1.5A. Either a 470 μF or 680 μF, 50V capacitor could be used.</p> <p>For a through hole design, a 680 μF/50V electrolytic capacitor (Panasonic HFQ series or Nichicon PL series or equivalent) would be adequate. Other types or other manufacturers capacitors can be used provided the RMS ripple current ratings are adequate.</p> <p>For surface mount designs, solid tantalum capacitors can be used, but caution must be exercised with regard to the capacitor surge current rting (see Application Information or input capacitors in this data sheet). The TPS series available from AVX, and the 593D series from Sprague are both surge current tested.</p> <p><i>To further simplify the buck regulator design procedure, Texas Instruments is making available computer design software to be used with the Simple Switcher line of switching regulators. Switchers Made Simple (version 4.3 or later) is available on a 3½" diskette for IBM compatible computers.</i></p>

XH2596 Series Buck Regulator Design Procedure (Adjustable Output)

Table 2. Output Capacitor and Feedforward Capacitor Selection Table

Output Voltage (V)	Through Hole Output Capacitor			Surface Mount Output Capacitor		
	Panasonic HFQ Series (μF/V)	Nichicon PL Series (μF/V)	Feedforward Capacitor	AVX TPS Series (μF/V)	Sprague 595D Series (μF/V)	Feedforward Capacitor
2	820/35	820/35	33 nF	330/6.3	470/4	33 nF
4	560/35	470/35	10 nF	330/6.3	390/6.3	10 nF
6	470/25	470/25	3.3 nF	220/10	330/10	3.3 nF

Table 2. Output Capacitor and Feedforward Capacitor Selection Table (continued)

Output Voltage (V)	Through Hole Output Capacitor			Surface Mount Output Capacitor		
	Panasonic HFQ Series (μF/V)	Nichicon PL Series (μF/V)	Feedforward Capacitor	AVX TPS Series (μF/V)	Sprague 595D Series (μF/V)	Feedforward Capacitor
9	330/25	330/25	1.5 nF	100/16	180/16	1.5 nF
12	330/25	330/25	1 nF	100/16	180/16	1 nF
15	220/35	220/35	680 pF	68/20	120/20	680 pF
24	220/35	150/35	560 pF	33/25	33/25	220 pF
28	100/50	100/50	390 pF	10/35	15/50	220 pF

XH2596 Series Buck Regulator Design Procedure

INDUCTOR VALUE SELECTION GUIDES

(For Continuous Mode Operation)

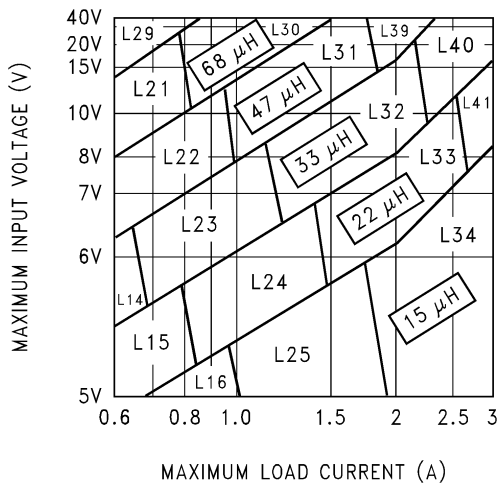

Figure 21. XH2596-3.3

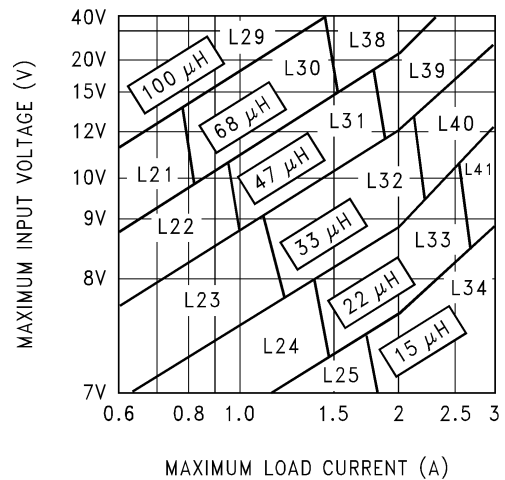

Figure 22. XH2596-5.0

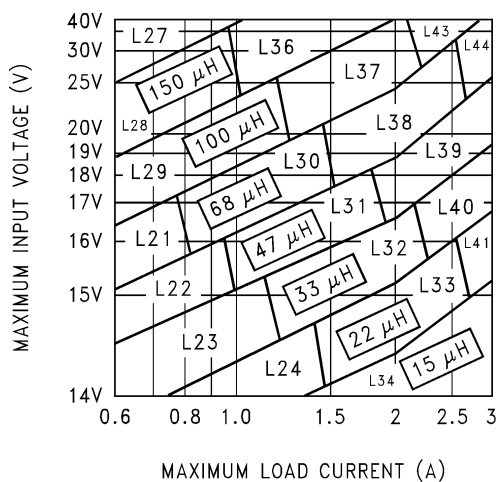
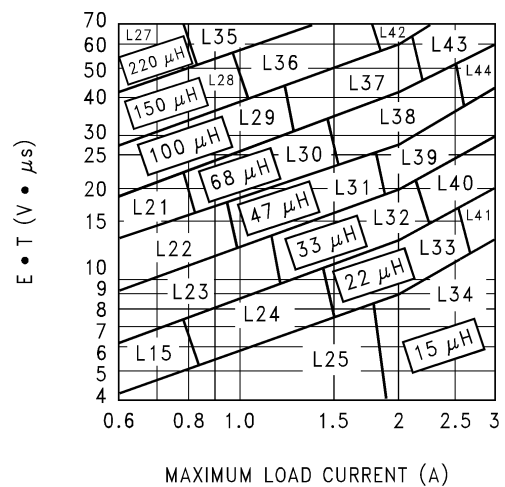
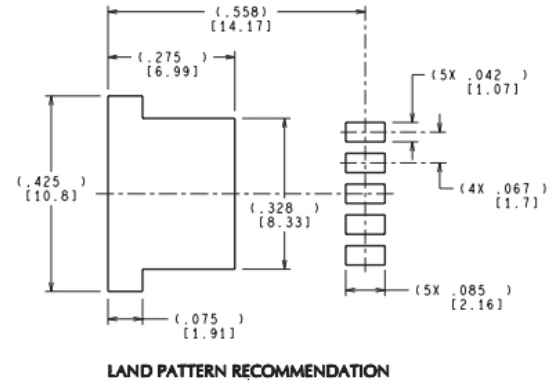
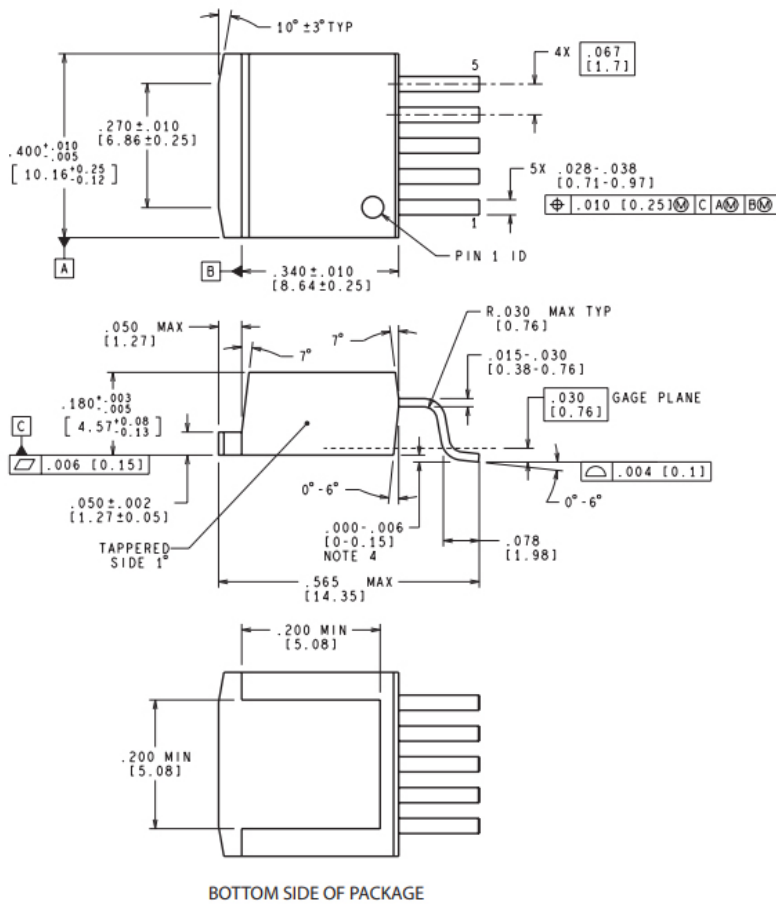

Figure 23. XH2596-12



XHure 24. XH2596-ADJ



以上信息仅供参考. 如需帮助联系客服人员。谢谢 XINLUDA

X-ON Electronics

Largest Supplier of Electrical and Electronic Components

Click to view similar products for [Switching Controllers](#) category:

Click to view products by [XINLUDA](#) manufacturer:

Other Similar products are found below :

[LV5065VB-TLM-H](#) [LV5066V-TLM-H](#) [LV5725JAZ-AH](#) [633888R](#) [MP2908AGF](#) [AZ7500EP-E1](#) [NCP1012AP133G](#) [NCP1217P133G](#)
[NCP1218AD65R2G](#) [NCP1234AD100R2G](#) [NCP1244BD065R2G](#) [NCP1336ADR2G](#) [NCP1587GDR2G](#) [NCP6153MNTWG](#)
[NCP81005MNTWG](#) [NCP81101BMNTXG](#) [NCP81205MNTXG](#) [HV9123NG-G-M934](#) [IR35207MTRPBF](#) [ISL6367HIRZ](#) [CAT874-80ULGT3](#)
[SJ6522AG](#) [SJE6600](#) [TLE63893GV50XUMA1](#) [IR35215MTRPBF](#) [SG3845DM](#) [NCP1216P133G](#) [NCP1236DD65R2G](#) [NCP1247BD100R2G](#)
[NCP1250BP65G](#) [NCP4202MNR2G](#) [NCP4204MNTXG](#) [NCP6132AMNR2G](#) [NCP81141MNTXG](#) [NCP81142MNTXG](#) [NCP81172MNTXG](#)
[NCP81203MNTXG](#) [NCP81206MNTXG](#) [NX2155HCUPTR](#) [UC3845ADM](#) [UBA2051C](#) [IR35201MTRPBF](#) [MAX8778ETJ+](#)
[MAX17500AAUB+T](#) [MAX17411GTM+T](#) [MAX16933ATIR/V+](#) [NCP1010AP130G](#) [NCP1063AD100R2G](#) [NCP1216AP133G](#)
[NCP1217AP100G](#)