

## 1. DESCRIPTION

The XL2110(S)PBF/XL2113(S)PBF are high voltage, high speed power MOSFET and IGBT drivers with independent high and low side referenced output channels. Proprietary HVIC and latch immune CMOS technologies enable ruggedized monolithic construction. Logic inputs are compatible with standard CMOS or LSTTL output, down to 3.3V logic. The output drivers feature a high pulse current buffer stage designed for minimum driver cross-conduction. Propagation delays are matched to simplify use in high frequency applications. The floating channel can be used to drive an N-channel power MOSFET or IGBT in the high side configuration which operates up to 500 or 600 volts.

## 2. FEATURES

- Floating channel designed for bootstrap operation
  - Fully operational to +500V or +600V
  - Tolerant to negative transient voltage
  - dV/dt immune
- Gate drive supply range from 10 to 20V
- Undervoltage lockout for both channels
- 3.3V logic compatible
  - Separate logic supply range from 3.3V to 20V
  - Logic and power ground  $\pm 5V$  offset
- CMOS Schmitt-triggered inputs with pull-down
- Cycle by cycle edge-triggered shutdown logic
- Matched propagation delay for both channels
- Outputs in phase with inputs
- Package option: XL2110PBF (DIP14), XL2110SPBF (SOP16(W))  
XL2113PBF (DIP14) ,XL2113SPBF(SOP16(W))

### 3. PIN CONFIGURATIONS AND FUNCTIONS

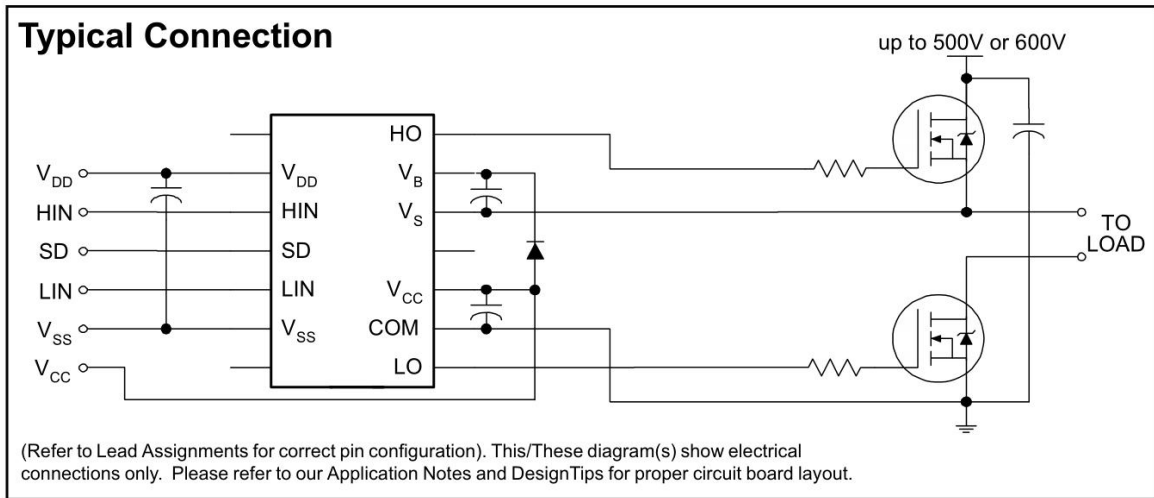

#### Lead Definitions

Symbol	Description
V <sub>DD</sub>	Logic supply
HIN	Logic input for high side gate driver output (HO), in phase
SD	Logic input for shutdown
LIN	Logic input for low side gate driver output (LO), in phase
V <sub>SS</sub>	Logic ground
V <sub>B</sub>	High side floating supply
HO	High side gate drive output
V <sub>S</sub>	High side floating supply return
V <sub>CC</sub>	Low side supply
LO	Low side gate drive output
COM	Low side return

#### 4. BLOCK DIAGRAM

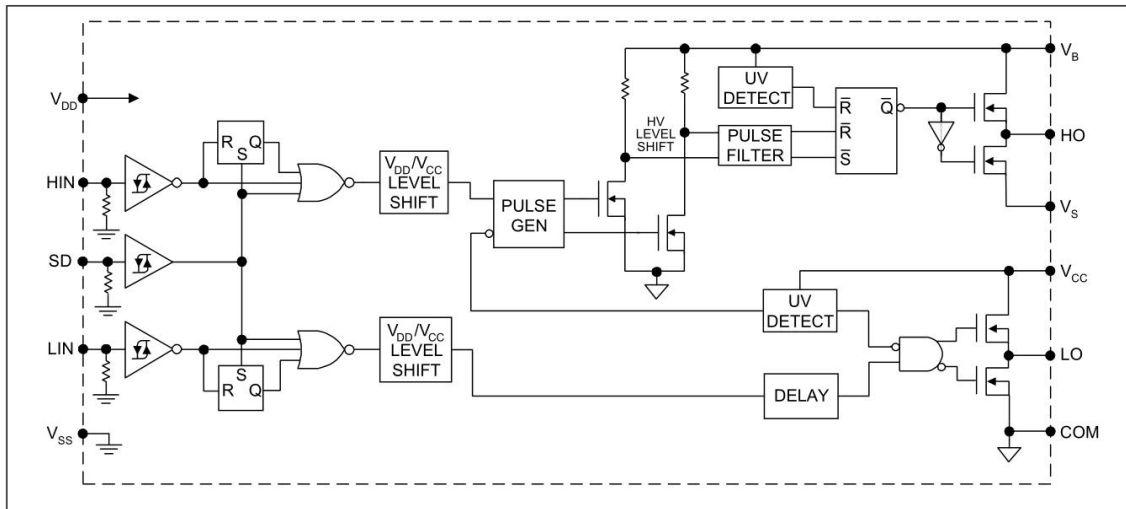

## 5. ABSOLUTE MAXIMUM RATINGS

Absolute maximum ratings indicate sustained limits beyond which damage to the device may occur. All voltage parameters are absolute voltages referenced to COM. The thermal resistance and power dissipation ratings are measured under board mounted and still air conditions. Additional information is shown in Figures 28 through 35.

Symbol	Definition	Min.	Max.	Units	
V <sub>B</sub>	High side floating supply voltage (XL2110)	-0.3	525	V	
	(XL2113)	-0.3	625		
V <sub>S</sub>	High side floating supply offset voltage	V <sub>B</sub> - 25	V <sub>B</sub> + 0.3		
V <sub>HO</sub>	High side floating output voltage	V <sub>S</sub> - 0.3	V <sub>B</sub> + 0.3		
V <sub>CC</sub>	Low side fixed supply voltage	-0.3	25		
V <sub>LO</sub>	Low side output voltage	-0.3	V <sub>CC</sub> + 0.3		
V <sub>DD</sub>	Logic supply voltage	-0.3	V <sub>SS</sub> + 25		
V <sub>SS</sub>	Logic supply offset voltage	V <sub>CC</sub> - 25	V <sub>CC</sub> + 0.3		
V <sub>IN</sub>	Logic input voltage (HIN, LIN & SD)	V <sub>SS</sub> - 0.3	V <sub>DD</sub> + 0.3		
dV <sub>S</sub> /dt	Allowable offset supply voltage transient (figure 2)	—	50		V/ns
P <sub>D</sub>	Package power dissipation @ T <sub>A</sub> ≤ +25°C	(14 lead DIP)	—	1.6	W
		(16 lead SOIC)	—	1.25	
R <sub>THJA</sub>	Thermal resistance, junction to ambient	(14 lead DIP)	—	75	°C/W
		(16 lead SOIC)	—	100	
T <sub>J</sub>	Junction temperature	—	150	°C	
T <sub>S</sub>	Storage temperature	-55	150		
T <sub>L</sub>	Lead temperature (soldering, 10 seconds)	—	300		

## 6. RECOMMENDED OPERATING CONDITIONS

The input/output logic timing diagram is shown in figure 1. For proper operation the device should be used within the recommended conditions. The V<sub>S</sub> and V<sub>SS</sub> offset ratings are tested with all supplies biased at 15V differential. Typical ratings at other bias conditions are shown in figures 36 and 37.

Symbol	Definition	Min.	Max.	Units
V <sub>B</sub>	High side floating supply absolute voltage	V <sub>S</sub> + 10	V <sub>S</sub> + 20	V
V <sub>S</sub>	High side floating supply offset voltage (XL2110)	Note 1	500	
	(XL2113)	Note 1	600	
V <sub>HO</sub>	High side floating output voltage	V <sub>S</sub>	V <sub>B</sub>	
V <sub>CC</sub>	Low side fixed supply voltage	10	20	
V <sub>LO</sub>	Low side output voltage	0	V <sub>CC</sub>	
V <sub>DD</sub>	Logic supply voltage	V <sub>SS</sub> + 3	V <sub>SS</sub> + 20	
V <sub>SS</sub>	Logic supply offset voltage	-5 (Note 2)	5	
V <sub>IN</sub>	Logic input voltage (HIN, LIN & SD)	V <sub>SS</sub>	V <sub>DD</sub>	
T <sub>A</sub>	Ambient temperature	-40	85	°C

Note 1: Logic operational for V<sub>S</sub> of -4 to +500V. Logic state held for V<sub>S</sub> of -4V to -V<sub>BS</sub>. (Please refer to the Design Tip DT97-3 for more details).

Note 2: When V<sub>DD</sub> < 5V, the minimum V<sub>SS</sub> offset is limited to -V<sub>DD</sub>.

## 7. DYNAMIC ELECTRICAL CHARACTERISTICS

$V_{BIAS} (V_{CC}, V_{BS}, V_{DD}) = 15V$ ,  $C_L = 1000 \text{ pF}$ ,  $T_A = 25^\circ\text{C}$  and  $V_{SS} = \text{COM}$  unless otherwise specified. The dynamic electrical characteristics are measured using the test circuit shown in Figure 3.

Symbol	Definition	Figure	Min.	Typ.	Max.	Units	Test Conditions	
$t_{on}$	Turn-on propagation delay	7	—	120	150	ns	$V_S = 0V$	
$t_{off}$	Turn-off propagation delay	8	—	94	125		$V_S = 500V/600V$	
$t_{sd}$	Shutdown propagation delay	9	—	110	140		$V_S = 500V/600V$	
$t_r$	Turn-on rise time	10	—	25	35			
$t_f$	Turn-off fall time	11	—	17	25			
MT	Delay matching, HS & LS turn-on/off	(XL2110)	—	—	—		10	
		(XL2113)	—	—	—		20	

## 8. STATIC ELECTRICAL CHARACTERISTICS

$V_{BIAS} (V_{CC}, V_{BS}, V_{DD}) = 15V$ ,  $T_A = 25^\circ\text{C}$  and  $V_{SS} = \text{COM}$  unless otherwise specified. The  $V_{IN}$ ,  $V_{TH}$  and  $I_{IN}$  parameters are referenced to  $V_{SS}$  and are applicable to all three logic input leads: HIN, LIN and SD. The  $V_O$  and  $I_O$  parameters are referenced to COM and are applicable to the respective output leads: HO or LO.

Symbol	Definition	Figure	Min.	Typ.	Max.	Units	Test Conditions
$V_{IH}$	Logic "1" input voltage	12	9.5	—	—	V	
$V_{IL}$	Logic "0" input voltage	13	—	—	6.0		
$V_{OH}$	High level output voltage, $V_{BIAS} - V_O$	14	—	—	1.2		$I_O = 0A$
$V_{OL}$	Low level output voltage, $V_O$	15	—	—	0.1		$I_O = 0A$
$I_{LK}$	Offset supply leakage current	16	—	—	50	$\mu A$	$V_B = V_S = 500V/600V$
$I_{QBS}$	Quiescent $V_{BS}$ supply current	17	—	125	230		$V_{IN} = 0V$ or $V_{DD}$
$I_{QCC}$	Quiescent $V_{CC}$ supply current	18	—	180	340		$V_{IN} = 0V$ or $V_{DD}$
$I_{QDD}$	Quiescent $V_{DD}$ supply current	19	—	15	30		$V_{IN} = 0V$ or $V_{DD}$
$I_{IN+}$	Logic "1" input bias current	20	—	20	40		$V_{IN} = V_{DD}$
$I_{IN-}$	Logic "0" input bias current	21	—	—	1.0	$V_{IN} = 0V$	
$V_{BSUV+}$	$V_{BS}$ supply undervoltage positive going threshold	22	7.5	8.6	9.7	V	
$V_{BSUV-}$	$V_{BS}$ supply undervoltage negative going threshold	23	7.0	8.2	9.4		
$V_{CCUV+}$	$V_{CC}$ supply undervoltage positive going threshold	24	7.4	8.5	9.6		
$V_{CCUV-}$	$V_{CC}$ supply undervoltage negative going threshold	25	7.0	8.2	9.4		
$I_{O+}$	Output high short circuit pulsed current	26	2.0	2.5	—	A	$V_O = 0V$ , $V_{IN} = V_{DD}$ $PW \leq 10 \mu s$
$I_{O-}$	Output low short circuit pulsed current	27	2.0	2.5	—		$V_O = 15V$ , $V_{IN} = 0V$ $PW \leq 10 \mu s$

## 9. LEAD ASSIGNMENTS

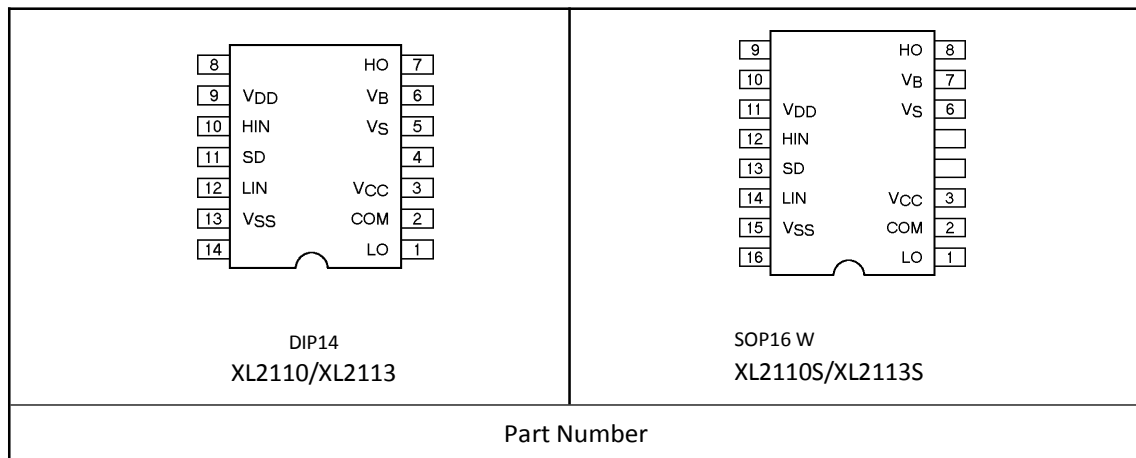

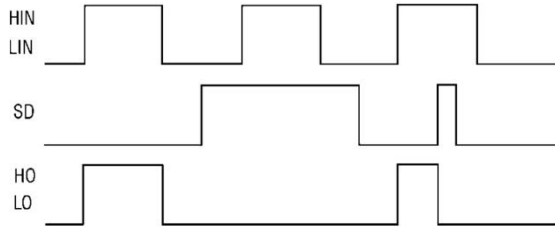

Figure 1. Input/Output Timing Diagram

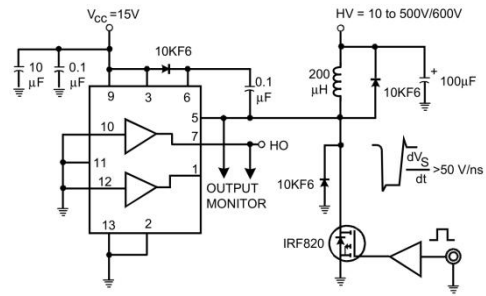

Figure 2. Floating Supply Voltage Transient Test Circuit

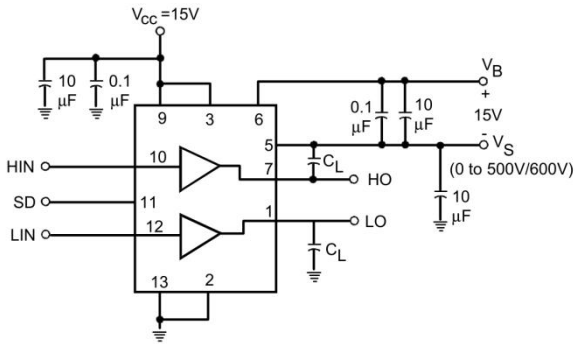

Figure 3. Switching Time Test Circuit

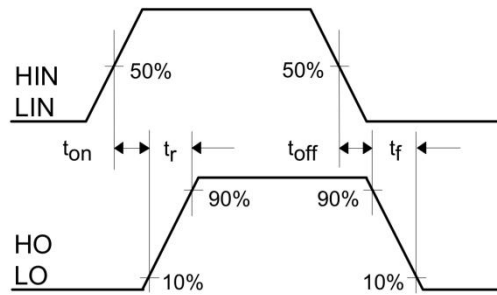

Figure 4. Switching Time Waveform Definition

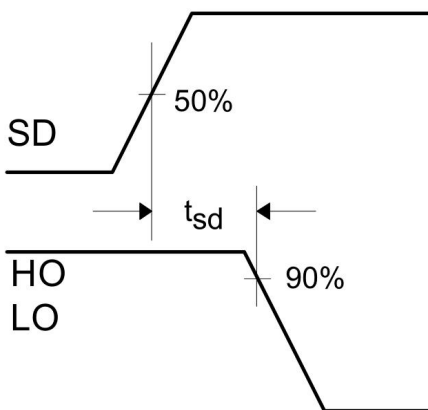

Figure 5. Shutdown Waveform Definitions

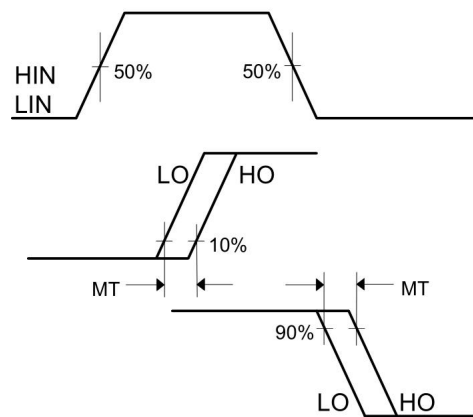

Figure 6. Delay Matching Waveform Definitions

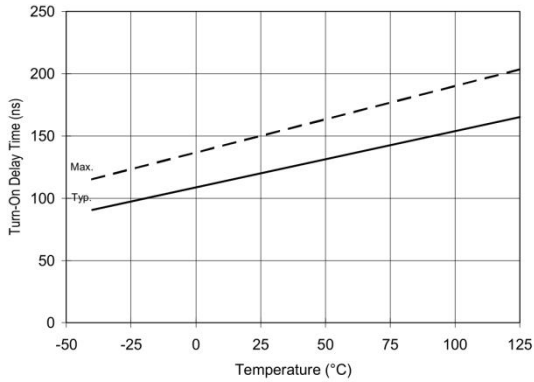

Figure 7A. Turn-On Time vs. Temperature

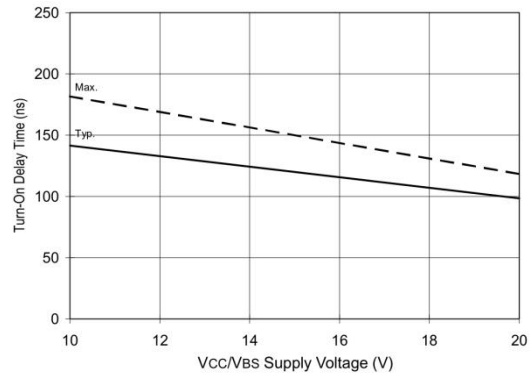

Figure 7B. Turn-On Time vs.  $V_{CC}/V_{BS}$  Supply Voltage

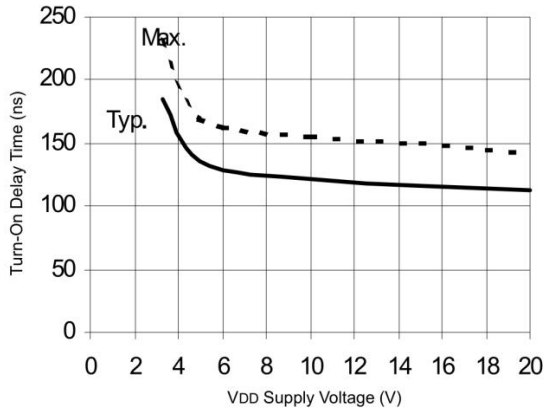

Figure 7C. Turn-On Time vs.  $V_{DD}$  Supply Voltage

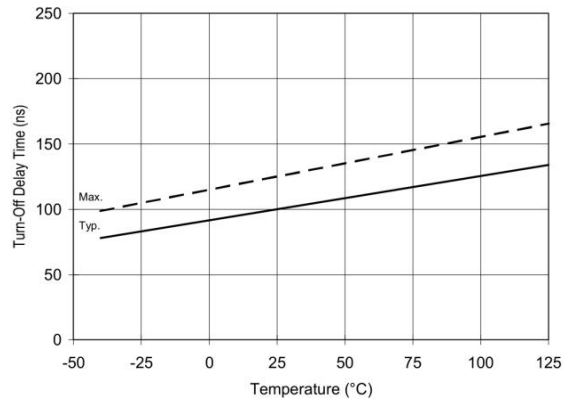

Figure 8A. Turn-Off Time vs. Temperature

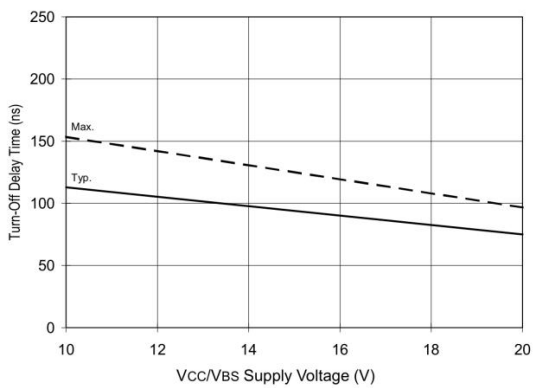

Figure 8B. Turn-Off Time vs.  $V_{CC}/V_{BS}$  Supply Voltage

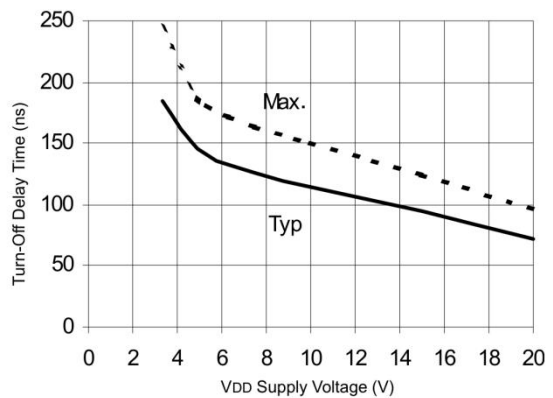

Figure 8C. Turn-Off Time vs.  $V_{DD}$  Supply Voltage



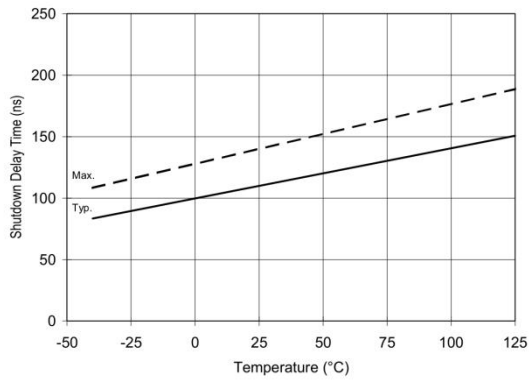

Figure 9A. Shutdown Time vs. Temperature

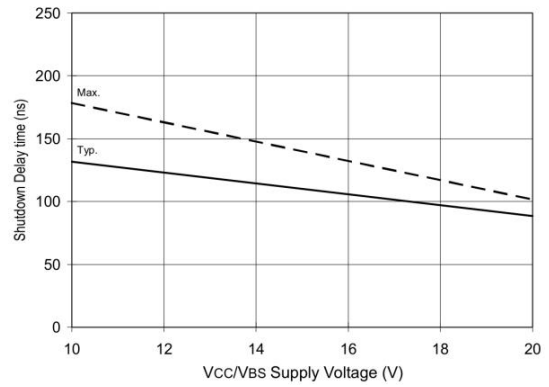

Figure 9B. Shutdown Time vs.  $V_{CC}/V_{BS}$  Supply Voltage

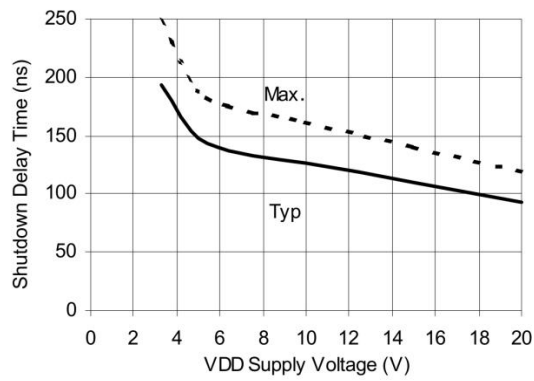

Figure 9C. Shutdown Time vs.  $V_{DD}$  Supply Voltage

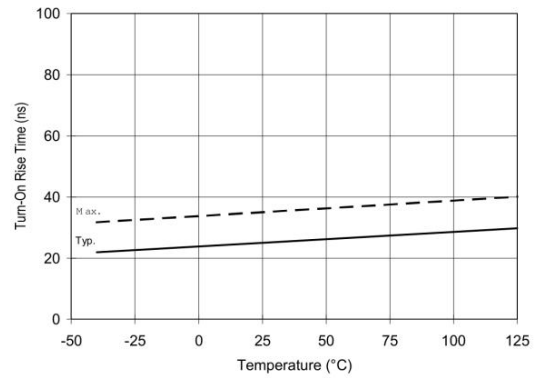

Figure 10A. Turn-On Rise Time vs. Temperature

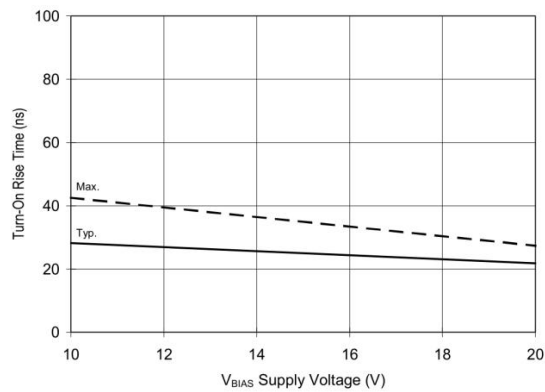

Figure 10B. Turn-On Rise Time vs. Voltage

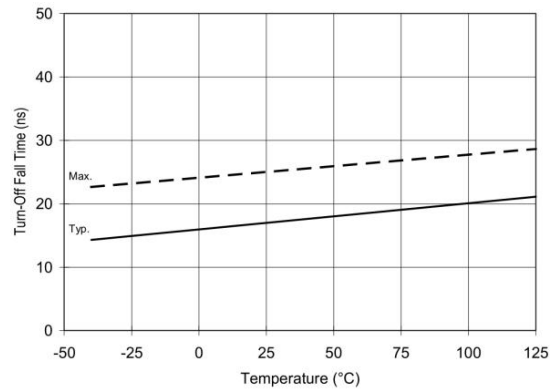

Figure 11A. Turn-Off Fall Time vs. Temperature

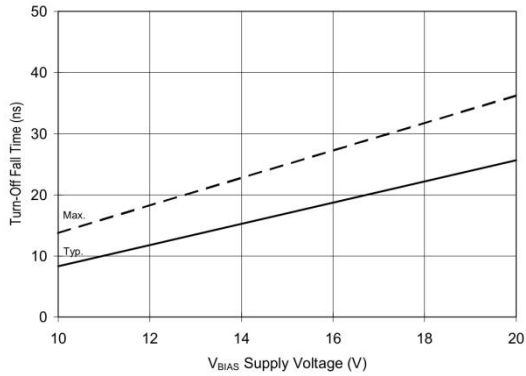

Figure 11B. Turn-Off Fall Time vs. Voltage

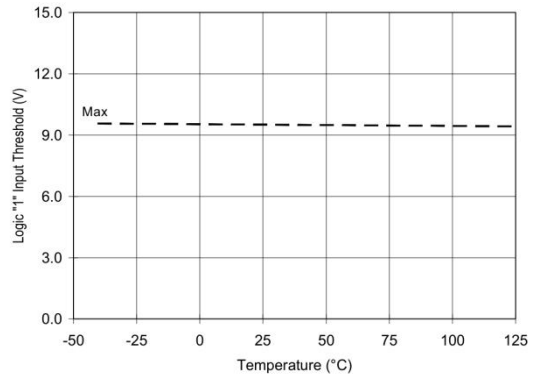

Figure 12A. Logic "1" Input Threshold vs. Temperature

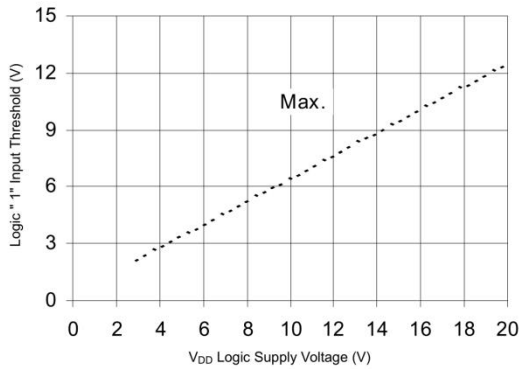

Figure 12B. Logic "1" Input Threshold vs. Voltage

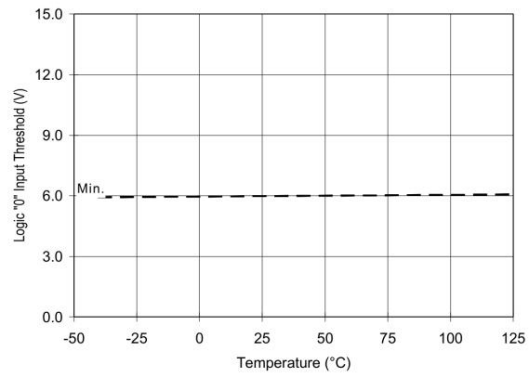

Figure 13A. Logic "0" Input Threshold vs. Temperature

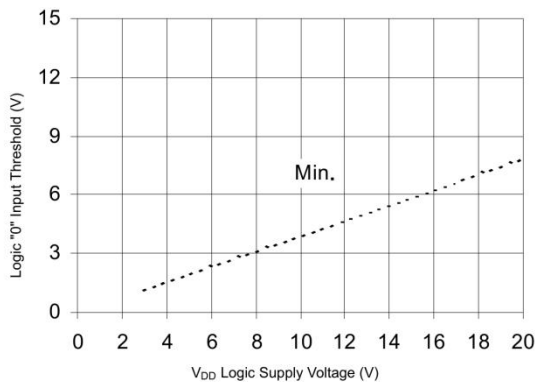

Figure 13B. Logic "0" Input Threshold vs. Voltage

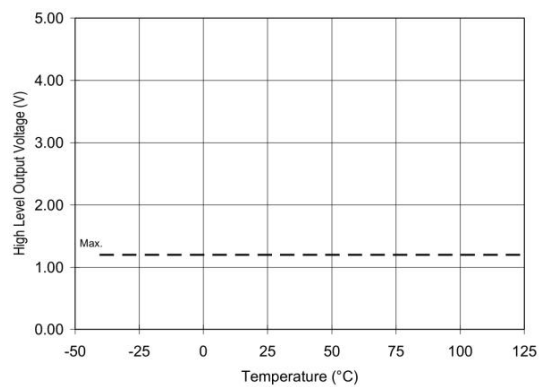

Figure 14A. High Level Output vs. Temperature

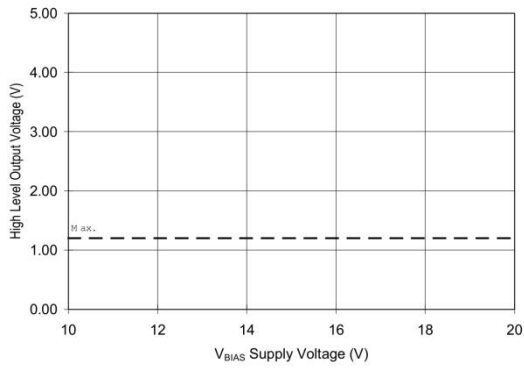

Figure 14B. High Level Output vs. Voltage

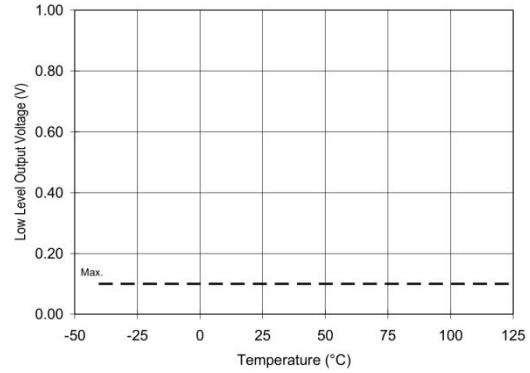

Figure 15A. Low Level Output vs. Temperature

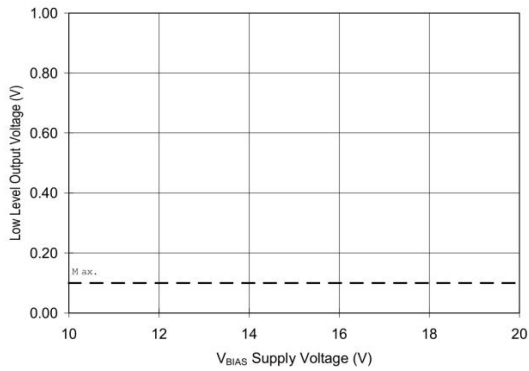

Figure 15B. Low Level Output vs. Voltage

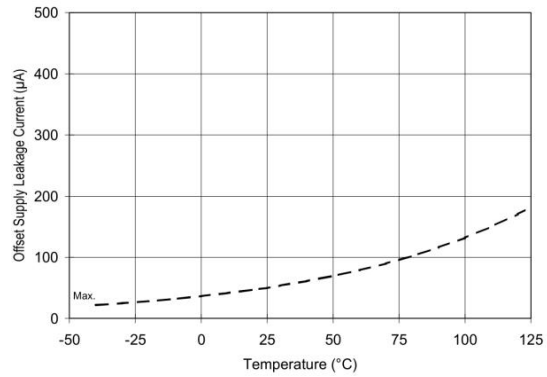

Figure 16A. Offset Supply Current vs. Temperature

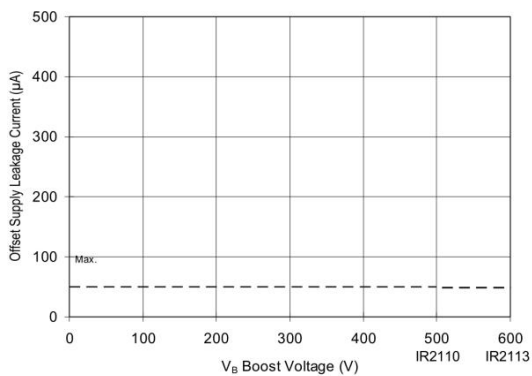

Figure 16B. Offset Supply Current vs. Voltage

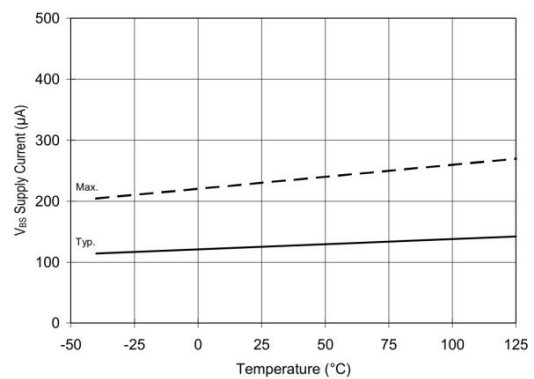

Figure 17A. V<sub>BS</sub> Supply Current vs. Temperature

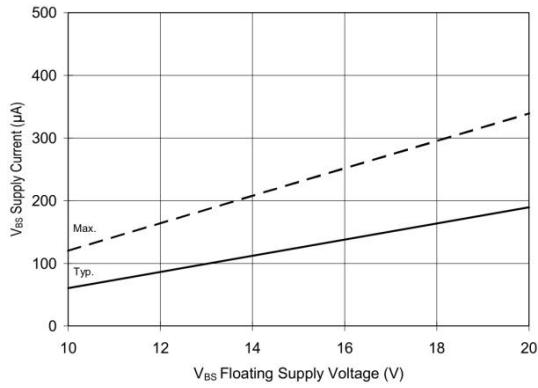

Figure 17B. V<sub>BS</sub> Supply Current vs. Voltage

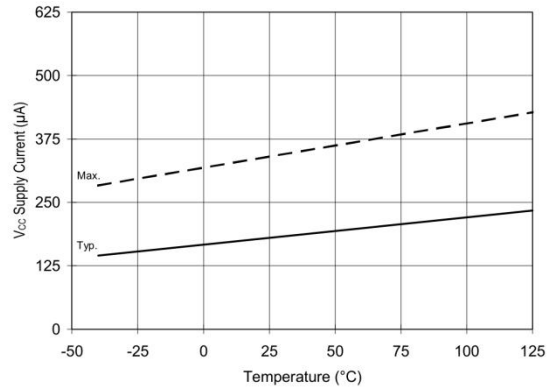

Figure 18A. V<sub>CC</sub> Supply Current vs. Temperature

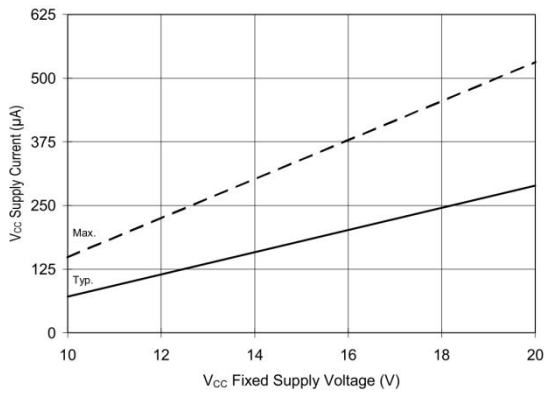

Figure 18B. V<sub>CC</sub> Supply Current vs. Voltage

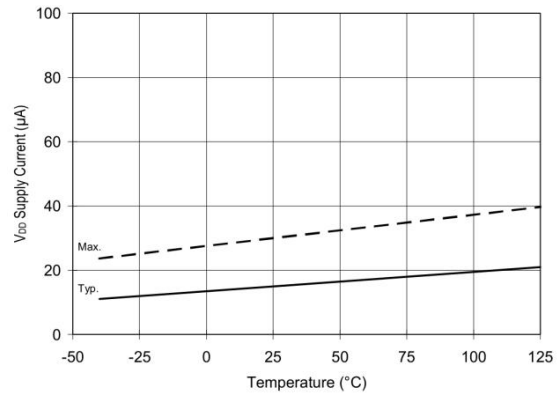

Figure 19A. V<sub>DD</sub> Supply Current vs. Temperature

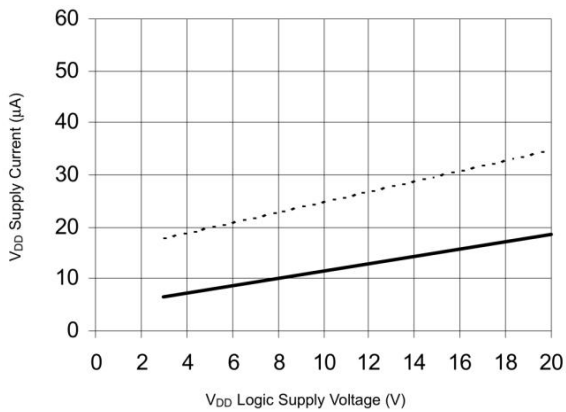

Figure 19B. V<sub>DD</sub> Supply Current vs. V<sub>DD</sub> Voltage

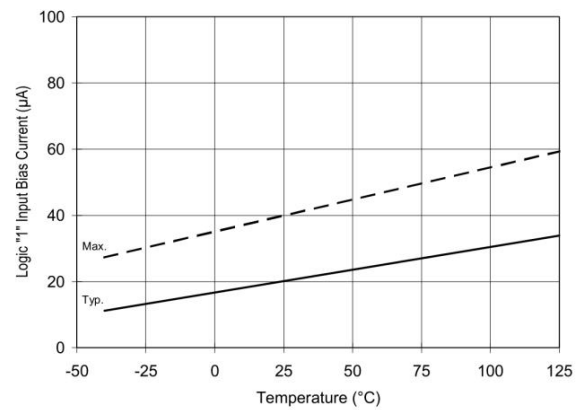

Figure 20A. Logic "1" Input Current vs. Temperature

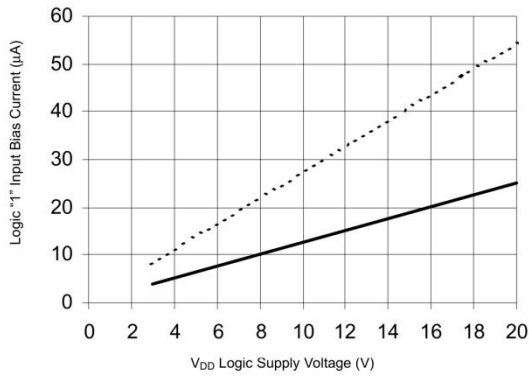

Figure 20B. Logic "1" Input Current vs. V<sub>DD</sub> Voltage

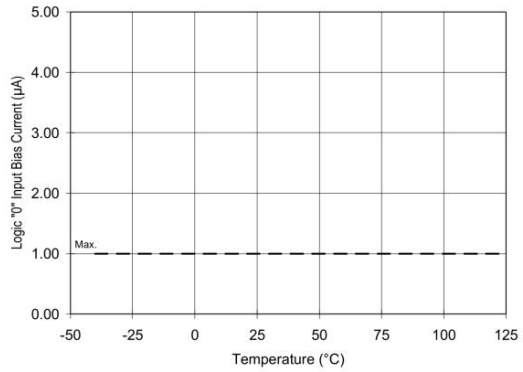

Figure 21A. Logic "0" Input Current vs. Temperature

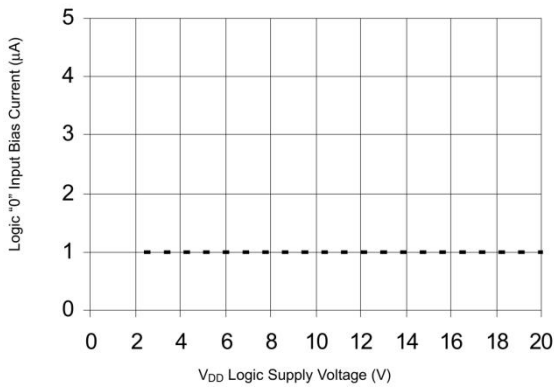

Figure 21B. Logic "0" Input Current vs. V<sub>DD</sub> Voltage

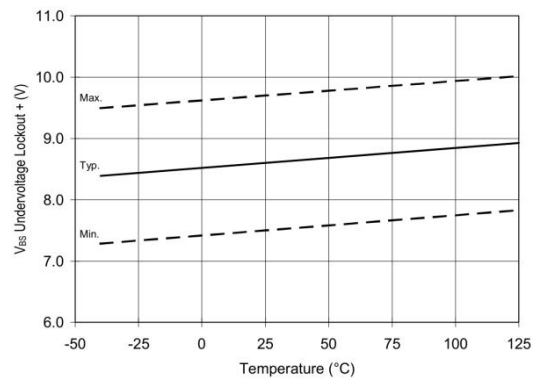

Figure 22. V<sub>BS</sub> Undervoltage (+) vs. Temperature

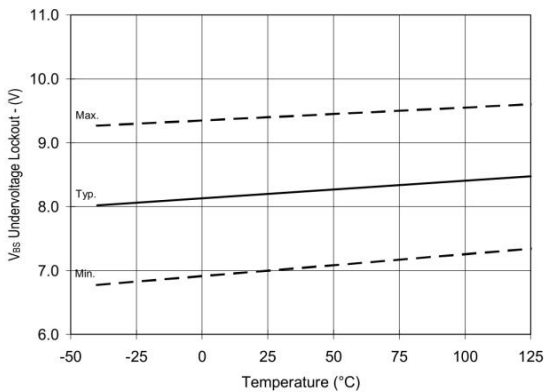

Figure 23. V<sub>BS</sub> Undervoltage (-) vs. Temperature

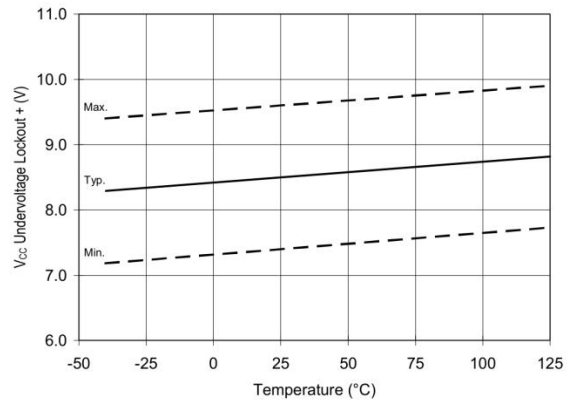

Figure 24. V<sub>CC</sub> Undervoltage (+) vs. Temperature

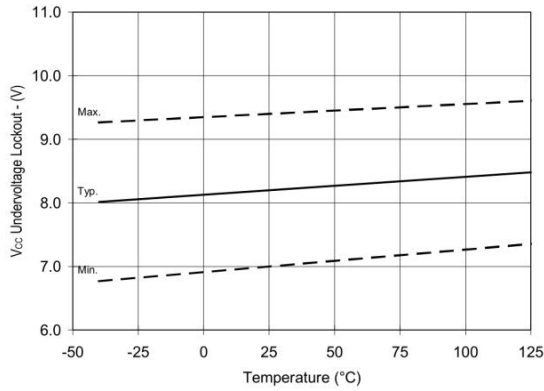

Figure 25.  $V_{CC}$  Undervoltage (-) vs. Temperature

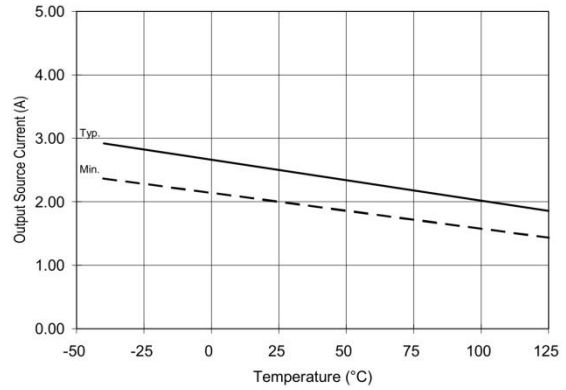

Figure 26A. Output Source Current vs. Temperature

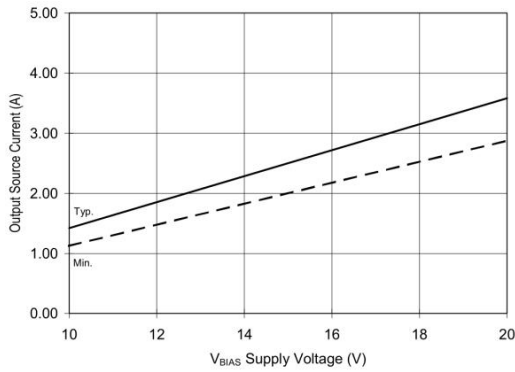

Figure 26B. Output Source Current vs. Voltage

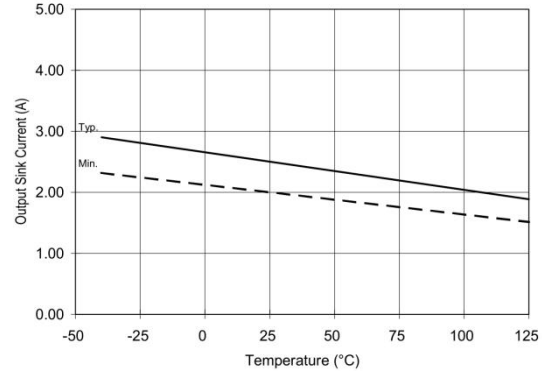

Figure 27A. Output Sink Current vs. Temperature

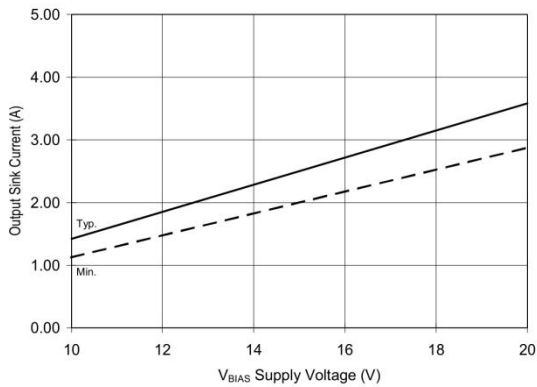

Figure 27B. Output Sink Current vs. Voltage

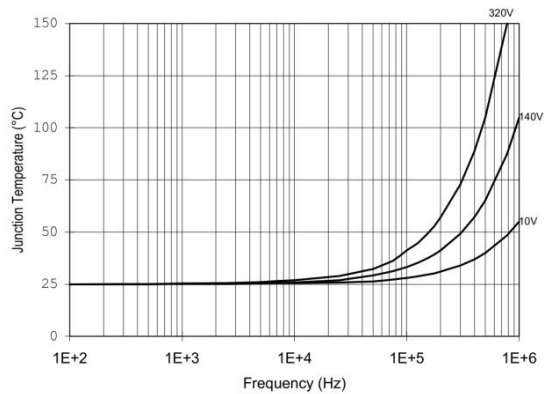

Figure 28. XL2110/XL2113  $T_J$  vs. Frequency (IRFBC20)  $R_{GATE} = 33\Omega$ ,  $V_{CC} = 15V$

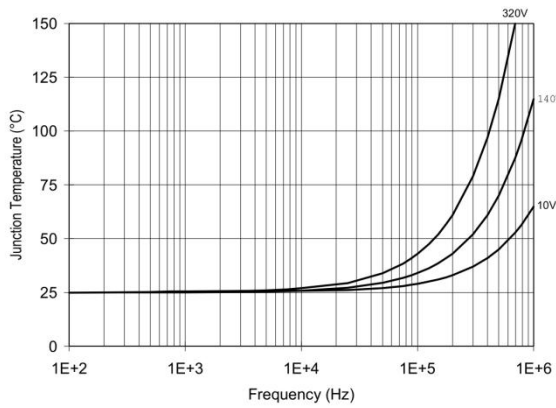

Figure 29. XL2110/XL2113 TJ vs. Frequency (IRFBC30) RGATE = 22Ω, VCC = 15V

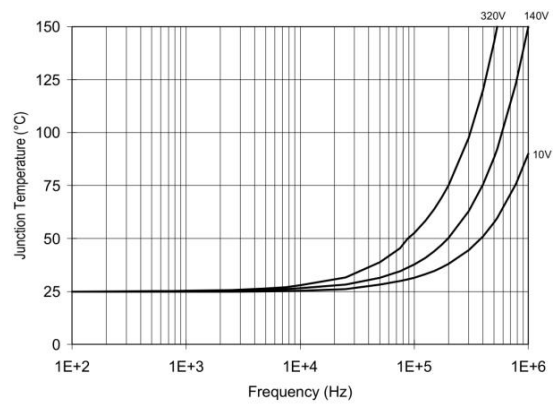

Figure 30. XL2110/XL2113 TJ vs. Frequency (IRFBC40) RGATE = 15Ω, VCC = 15V

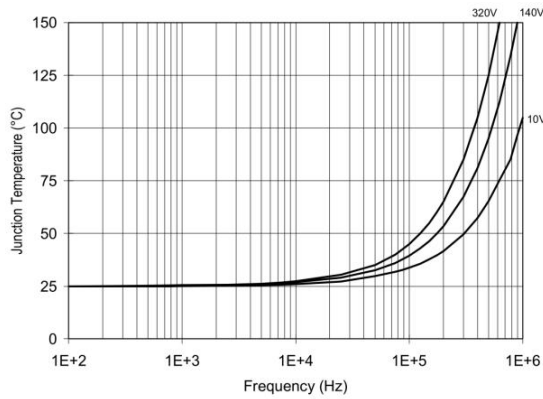

Figure 31. XL2110/XL2113 TJ vs. Frequency (IRFPE50) RGATE = 10Ω, VCC = 15V

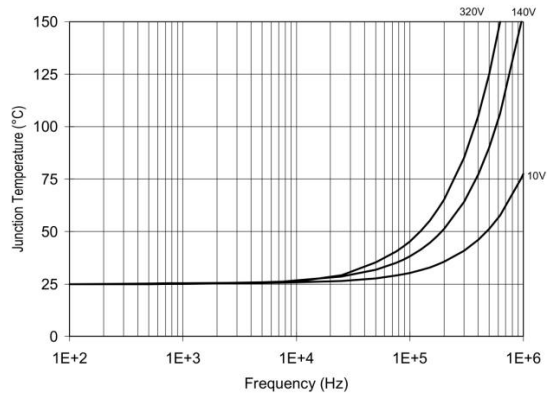

Figure 32. XL2110S/XL2113S TJ vs. Frequency (IRFBC20) RGATE = 33Ω, VCC = 15V

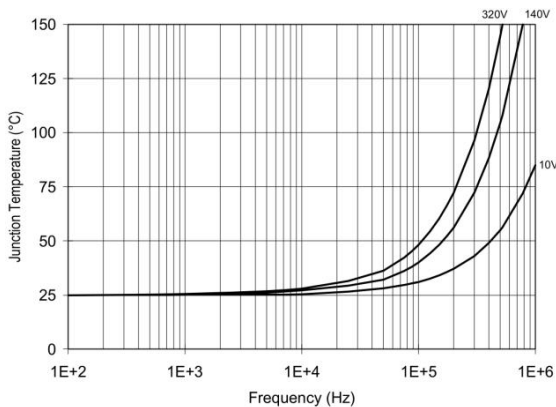

Figure 33. XL2110S/XL2113S TJ vs. Frequency (IRFBC30) RGATE = 22Ω, VCC = 15V

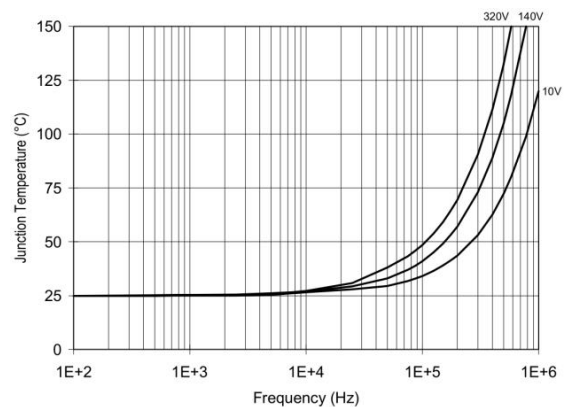

Figure 34. XL2110S/XL2113S TJ vs. Frequency (IRFBC40) RGATE = 15Ω, VCC = 15V

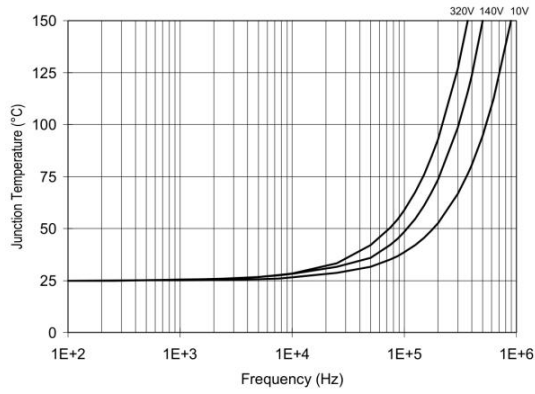

Figure 35. XL2110S/XL2113S T<sub>J</sub> vs. Frequency (IRFPE50) R<sub>GATE</sub> = 10Ω, V<sub>CC</sub> = 15V

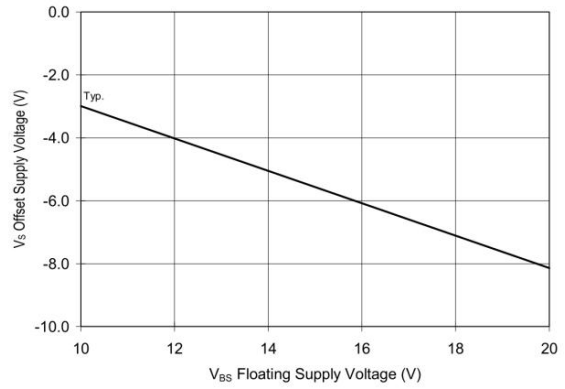

Figure 36. Maximum V<sub>S</sub> Negative Offset vs. V<sub>BS</sub> Supply Voltage

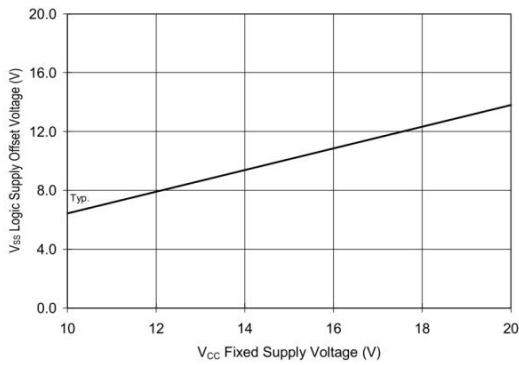

Figure 37. Maximum V<sub>SS</sub> Positive Offset vs. V<sub>CC</sub> Supply Voltage



## 10. ORDERING INFORMATION

Ordering Information

Part Number	Device Marking	Package Type	Body size (mm)	Temperature (°C)	MSL	Transport Media	Package Quantity
XL2110PBF	XL2110	DIP14	19.05 * 6.35	- 40 to +85	MSL3	Tube 25	1000
XL2110SPBF	XL2110S	SOP16(W)	10.45 * 7.5	- 40 to +85	MSL3	T&R	1000
XL2113PBF	XL2113	DIP14	19.05 * 6.35	- 40 to +85	MSL3	Tube 25	1000
XL2113SPBF	XL2113S	SOP16(W)	10.45 * 7.5	- 40 to +85	MSL3	T&R	1000

## 11. DIMENSIONAL DRAWINGS

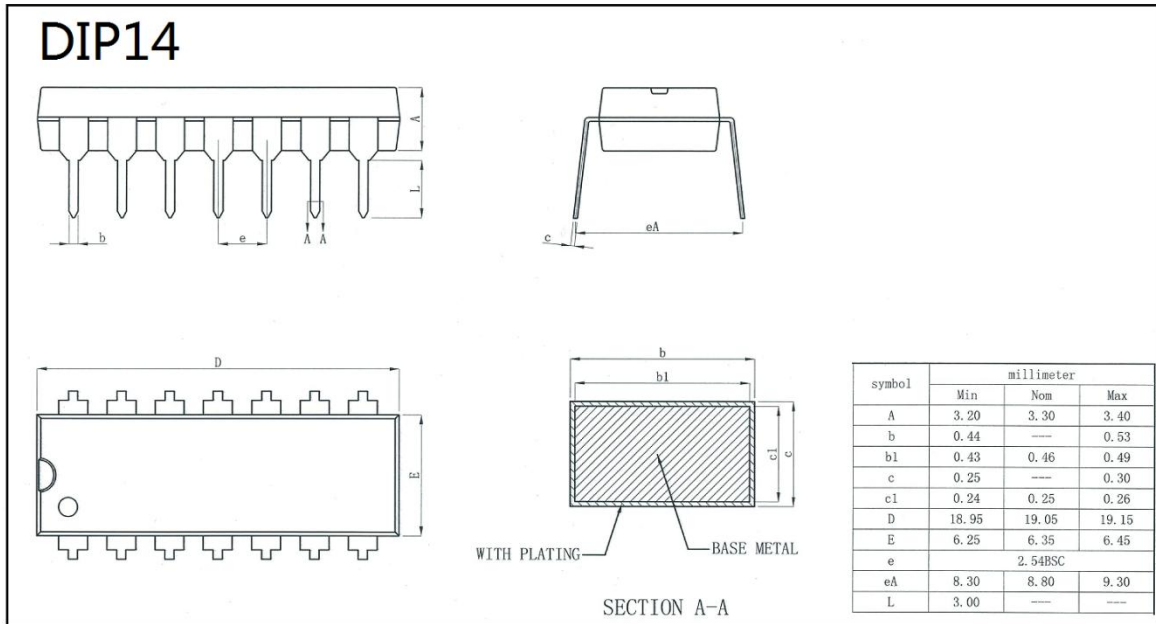

# SOP16(W)

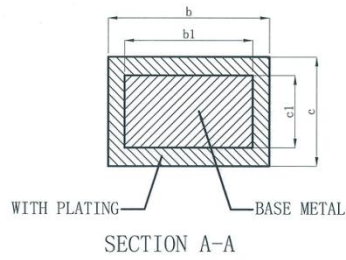
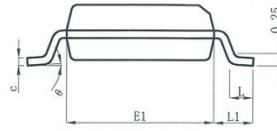
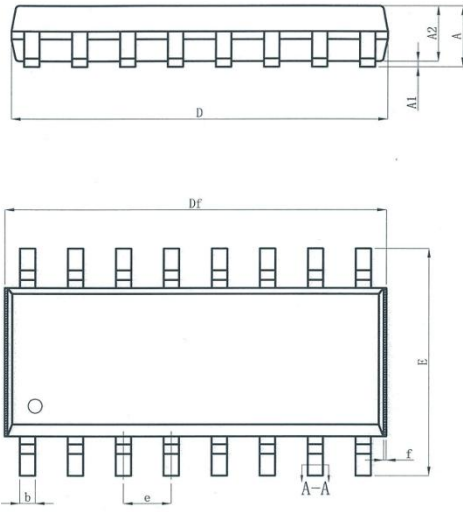

symbol	millimeter		
	Min	Nom	Max
A	---	---	2.65
A1	0.10	0.20	0.30
A2	2.20	2.30	2.40
b	0.39	---	0.47
b1	0.38	0.41	0.43
c	0.25	---	0.30
c1	0.24	0.25	0.26
D	10.10	10.20	10.30
Df	10.20	---	10.70
E	10.26	10.41	10.60
E1	7.40	7.50	7.60
e	1.27BSC		
L	0.55	---	0.85
L1	---	1.40	---
θ	0°	---	8°
f	0.05	---	0.20

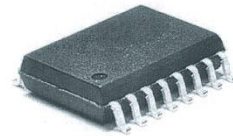

[ if you need help contact us. Xinluda reserves the right to change the above information without prior notice ]

## X-ON Electronics

Largest Supplier of Electrical and Electronic Components

*Click to view similar products for [Gate Drivers](#) category:*

*Click to view products by [XINLUDA](#) manufacturer:*

Other Similar products are found below :

[56956](#) [57.404.7355.5](#) [LT4936](#) [57.904.0755.0](#) [5811-0902](#) [0131700000](#) [LTP70N06](#) [LVP640](#) [5J0-1000LG-SIL](#) [LY2-US-AC240](#) [LY3-UA-DC24](#) [LZNQ2-US-DC12](#) [LZP40N10](#) [60100564](#) [60249-1-CUT-TAPE](#) [0134220000](#) [6035](#) [60713816](#) [61161-90](#) [6131-204-23149P](#) [6131-205-17149P](#) [6131-209-15149P](#) [6131-218-17149P](#) [6131-220-21149P](#) [6131-260-2358P](#) [6131-265-11149P](#) [CS1HCPU63](#) [6150-5001](#) [CSB4](#) [CSK-38-60006](#) [CSK-38-60008](#) [621A](#) [622-4053LF](#) [6273](#) [M40N08MA-H](#) [M55155/29XH06](#) [64-807](#) [65-1930-6](#) [CV500ISB02](#) [M83723/88Y1407N](#) [CWD012-2](#) [CWD03-3](#) [CX3225SB16934D0PPSC2](#) [CX5032GB10000D0PPS02](#) [687-772NF1](#) [70.140.1653](#) [70.200.0653.0](#) [703001B01F060](#) [70-3601](#) [706006D02F0601](#)