FEATURES

- **5V, 12V, ADJ, and Adjustable Output Versions**
- **Adjustable Version Output Voltage Range, 1.2V to 37V (57V for the HV Version)±4% Max Over Line and Load Conditions**
- **Available in 8-pin Surface Mount SOIC and PDIP-8 Package**
- **Ensured 0.5A Output Current**
- **Input Voltage Range up to 60V**
- **Requires only 4 External Components**
- **150 kHz Fixed Frequency Internal Oscillator**
- **TTL Shutdown Capability**
- **Low Power Standby Mode, I_Q typically 85 μA**
- **High Efficiency**
- **Uses Readily Available Standard Inductors**
- **Thermal Shutdown and Current Limit Protection**

APPLICATIONS

- **Simple High-efficiency Step-down (Buck) Regulator**
- **Efficient Pre-regulator for Linear Regulators**
- **On-card Switching Regulators**
- **Positive to Negative Converter**

DESCRIPTION

The XL2594 series of regulators are monolithic integrated circuits that provide all the active functions for a step-down (buck) switching regulator, capable of driving a 0.5A load with excellent line and load regulation. These devices are available in fixed output voltages of 5V, 12V, ADJ and an adjustable output version, and are packaged in a 8-lead PDIP and a 8-lead surface mount SOIC package.

Requiring a minimum number of external components, these regulators are simple to use and feature internal frequency compensation†, a fixed-frequency oscillator, and improved line and load regulation specifications.

The XL2594 series operates at a switching frequency of 150 kHz thus allowing smaller sized filter components than what would be needed with lower frequency switching regulators. Because of its high efficiency, the copper traces on the printed circuit board are normally the only heat sinking needed.

A standard series of inductors (both through hole and surface mount types) are available from several different manufacturers optimized for use with the XL2594 series. This feature greatly simplifies the design of switch-mode power supplies.

Other features include an ensured ±4% tolerance on output voltage under all conditions of input voltage and output load conditions, and ±15% on the oscillator frequency. External shutdown is included, featuring typically 85 μA standby current. Self protection features include a two stage frequency reducing current limit for the output switch and an over temperature shutdown for complete protection under fault conditions.

The XL2594 is for applications requiring an input voltage up to 60V.

Absolute Maximum Ratings⁽¹⁾⁽²⁾

Maximum Supply Voltage		
XL2594		45V
$\overline{\text{ON}}$ /OFF Pin Input Voltage		$-0.3 \leq V \leq +25\text{V}$
Feedback Pin Voltage		$-0.3 \leq V \leq +25\text{V}$
Output Voltage to Ground (Steady State)		-1V
Power Dissipation		Internally limited
Storage Temperature Range		-65°C to $+150^\circ\text{C}$
ESD Susceptibility	Human Body Model ⁽³⁾	2 kV
Lead Temperature		
D8 Package	Vapor Phase (60 sec.)	$+215^\circ\text{C}$
	Infrared (15 sec.)	$+220^\circ\text{C}$
P Package (Soldering, 10 sec.)		$+260^\circ\text{C}$
Maximum Junction Temperature		$+150^\circ\text{C}$

- (1) Absolute Maximum Ratings indicate limits beyond which damage to the device may occur. Operating Ratings indicate conditions for which the device is intended to be functional, but do not ensure specific performance limits. For ensured specifications and test conditions, see the Electrical Characteristics.

Operating Conditions

Temperature Range	$-40^\circ\text{C} \leq T_J \leq +125^\circ\text{C}$
Supply Voltage	
XL2594	4.5V to 40V

XL2594 Electrical Characteristics

Specifications with standard type face are for $T_J = 25^\circ\text{C}$, and those with **boldface type** apply over **full Operating Temperature Range**. $V_{\text{INmax}} = 40\text{V}$ for the LM2594 and 60V for the LM2594HV.

Symbol	Parameter	Conditions	XL2594		Units (Limits)
			Typ ⁽¹⁾	Limit ⁽²⁾	
SYSTEM PARAMETERS⁽³⁾ Test Circuit Figure 16					
V_{OUT}	Output Voltage	$4.75\text{V} \leq V_{\text{IN}} \leq V_{\text{INmax}}$, $0.1\text{A} \leq I_{\text{LOAD}} \leq 0.5\text{A}$	3.3	3.432/ 3.465 3.168/ 3.135	V V(min) V(max)
η	Efficiency	$V_{\text{IN}} = 12\text{V}$, $I_{\text{LOAD}} = 0.5\text{A}$	80		%

- (1) Typical numbers are at 25°C and represent the most likely norm.
- (2) All limits ensured at room temperature (standard type face) and at temperature extremes (bold type face). All room temperature limits are 100% production tested. All limits at temperature extremes are specified via correlation using standard Statistical Quality Control (SQC) methods. All limits are used to calculate Average Outgoing Quality Level (AOQL).
- (3) External components such as the catch diode, inductor, input and output capacitors, and voltage programming resistors can affect switching regulator system performance. When the XL2594 is used as shown in the Figure 16 test circuit, system performance will be as shown in system parameters section of Electrical Characteristics.

XL2594 Electrical Characteristics

Specifications with standard type face are for $T_J = 25^\circ\text{C}$, and those with **boldface type** apply over **full Operating Temperature Range**

Symbol	Parameter	Conditions	XL2594		Units (Limits)
			Typ ⁽¹⁾	Limit ⁽²⁾	
SYSTEM PARAMETERS⁽³⁾ Test Circuit <i>Figure 16</i>					
V_{OUT}	Output Voltage	$7V \leq V_{IN} \leq V_{INmax}$, $0.1A \leq I_{LOAD} \leq 0.5A$	5.0	4.800/ 4.750 5.200/ 5.250	V V(min) V(max)
η	Efficiency	$V_{IN} = 12V$, $I_{LOAD} = 0.5A$	82		%

- (1) Typical numbers are at 25°C and represent the most likely norm.
- (2) All limits ensured at room temperature (standard type face) and at temperature extremes (bold type face). All room temperature limits are 100% production tested. All limits at temperature extremes are specified via correlation using standard Statistical Quality Control (SQC) methods. All limits are used to calculate Average Outgoing Quality Level (AOQL).
- (3) External components such as the catch diode, inductor, input and output capacitors, and voltage programming resistors can affect switching regulator system performance. When the XL2594 is used as shown in the Figure 16 test circuit, system performance will be as shown in system parameters section of Electrical Characteristics.

XL2594 Electrical Characteristics

Specifications with standard type face are for $T_J = 25^\circ\text{C}$, and those with **boldface type** apply over **full Operating Temperature Range**

Symbol	Parameter	Conditions	XL2594		Units (Limits)
			Typ ⁽¹⁾	Limit ⁽²⁾	
SYSTEM PARAMETERS⁽³⁾ Test Circuit <i>Figure 16</i>					
V_{OUT}	Output Voltage	$15V \leq V_{IN} \leq V_{INmax}$, $0.1A \leq I_{LOAD} \leq 0.5A$	12.0	11.52/ 11.40 12.48/ 12.60	V V(min) V(max)
η	Efficiency	$V_{IN} = 25V$, $I_{LOAD} = 0.5A$	88		%

- (1) Typical numbers are at 25°C and represent the most likely norm.
- (2) All limits ensured at room temperature (standard type face) and at temperature extremes (bold type face). All room temperature limits are 100% production tested. All limits at temperature extremes are specified via correlation using standard Statistical Quality Control (SQC) methods. All limits are used to calculate Average Outgoing Quality Level (AOQL).
- (3) External components such as the catch diode, inductor, input and output capacitors, and voltage programming resistors can affect switching regulator system performance. When the XL2594 is used as shown in the Figure 16 test circuit, system performance will be as shown in system parameters section of Electrical Characteristics.

XL2594 Electrical Characteristics

Specifications with standard type face are for $T_J = 25^\circ\text{C}$, and those with **boldface type** apply over **full Operating Temperature Range**

Symbol	Parameter	Conditions	XL2594		Units (Limits)
			Typ ⁽¹⁾	Limit ⁽²⁾	
SYSTEM PARAMETERS⁽³⁾ Test Circuit <i>Figure 16</i>					
V_{FB}	Feedback Voltage	$4.5V \leq V_{IN} \leq V_{INmax}$, $0.1A \leq I_{LOAD} \leq 0.5A$ V_{OUT} programmed for 3V. Circuit of <i>Figure 16</i>	1.230	1.193/ 1.180 1.267/ 1.280	V V(min) V(max)
η	Efficiency	$V_{IN} = 12V$, $I_{LOAD} = 0.5A$	80		%

- (1) Typical numbers are at 25°C and represent the most likely norm.
- (2) All limits ensured at room temperature (standard type face) and at temperature extremes (bold type face). All room temperature limits are 100% production tested. All limits at temperature extremes are specified via correlation using standard Statistical Quality Control (SQC) methods. All limits are used to calculate Average Outgoing Quality Level (AOQL).
- (3) External components such as the catch diode, inductor, input and output capacitors, and voltage programming resistors can affect switching regulator system performance. When the XL2594 is used as shown in the Figure 16 test circuit, system performance will be as shown in system parameters section of Electrical Characteristics.

All Output Voltage Versions Electrical Characteristics

Specifications with standard type face are for $T_J = 25^\circ\text{C}$, and those with **boldface type** apply over **full Operating Temperature Range**. Unless otherwise specified, $V_{IN} = 12\text{V}$ for the 3.3V, 5V, and Adjustable version and $V_{IN} = 24\text{V}$ for the 12V version. $I_{LOAD} = 100\text{mA}$

Symbol	Parameter	Conditions	XL2594		Units (Limits)
			Typ ⁽¹⁾	Limit ⁽²⁾	
DEVICE PARAMETERS					
I_b	Feedback Bias Current	Adjustable Version Only, $V_{FB} = 1.3\text{V}$	10	50/ 100	nA
f_O	Oscillator Frequency	See ⁽³⁾	150	127/ 110 173/ 173	kHz kHz(min) kHz(max)
V_{SAT}	Saturation Voltage	$I_{OUT} = 0.5\text{A}$ ⁽⁴⁾⁽⁵⁾	0.9	1.1/ 1.2	V V(max)
DC	Max Duty Cycle (ON)	See ⁽⁵⁾	100		%
	Min Duty Cycle (OFF)	See ⁽⁶⁾	0		
I_{CL}	Current Limit	Peak Current ⁽⁴⁾⁽⁵⁾	0.8	0.65/ 0.58 1.3/ 1.4	A A(min) A(max)
I_L	Output Leakage Current	Output = 0V ⁽⁴⁾⁽⁶⁾⁽⁷⁾ Output = -1V	2	50	$\mu\text{A}(\text{max})$
				15	mA(max)
I_Q	Quiescent Current	See ⁽⁶⁾	5		mA
				10	mA(max)
I_{STBY}	Standby Quiescent Current	ON/OFF pin = 5V (OFF) ⁽⁷⁾ XL2594	85		μA
			140	200/ 250 250/ 300	$\mu\text{A}(\text{max})$ $\mu\text{A}(\text{max})$
θ_{JA}	Thermal Resistance	P Package, Junction to Ambient ⁽⁸⁾	95		$^\circ\text{C/W}$
		MDPackage, Junction to Ambient ⁽⁸⁾	150		
ON/OFF CONTROL Test Circuit <i>Figure 16</i>					
V_{IH} V_{IL}	$\overline{\text{ON}}$ /OFF Pin Logic Input Threshold Voltage	Low (Regulator ON)	1.3	0.6	V V(max)
		High (Regulator OFF)		2.0	V(min)
I_H I_L	$\overline{\text{ON}}$ /OFF Pin Input Current	$V_{LOGIC} = 2.5\text{V}$ (Regulator OFF)	5	15	μA $\mu\text{A}(\text{max})$
		$V_{LOGIC} = 0.5\text{V}$ (Regulator ON)	0.02	5	μA $\mu\text{A}(\text{max})$

- (1) Typical numbers are at 25°C and represent the most likely norm.
- (2) All limits ensured at room temperature (standard type face) and at temperature extremes (bold type face). All room temperature limits are 100% production tested. All limits at temperature extremes are specified via correlation using standard Statistical Quality Control (SQC) methods. All limits are used to calculate Average Outgoing Quality Level (AOQL).
- (3) The switching frequency is reduced when the second stage current limit is activated. The amount of reduction is determined by the severity of current overload.
- (4) No diode, inductor or capacitor connected to output pin.
- (5) Feedback pin removed from output and connected to 0V to force the output transistor switch ON.
- (6) Feedback pin removed from output and connected to 12V for the 5V, and the ADJ. version, and 15V for the 12V version, to force the output transistor switch OFF.
- (7) $V_{IN} = 40\text{V}$ for the XL2594.

Typical Performance Characteristics

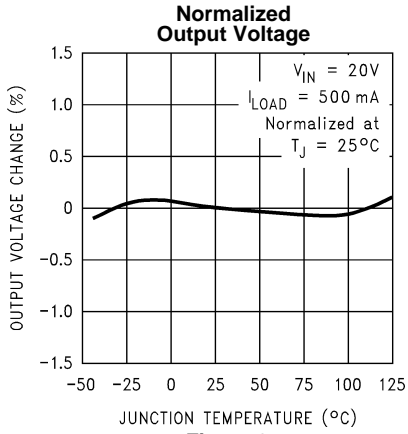

Figure 3.

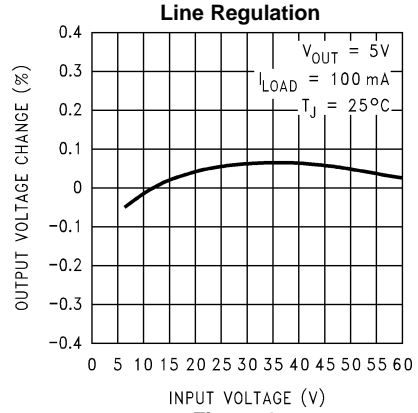

Figure 4.

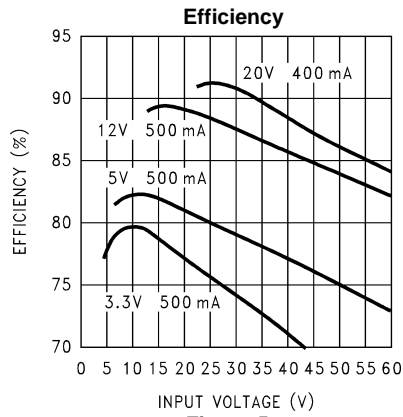

Figure 5.

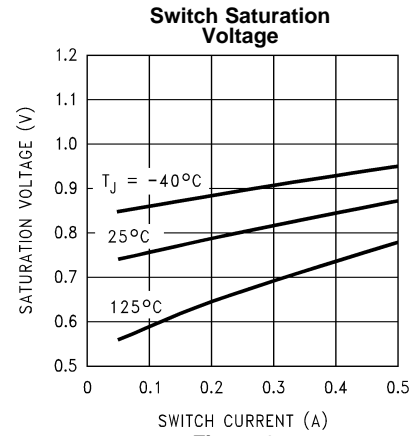

Figure 6.

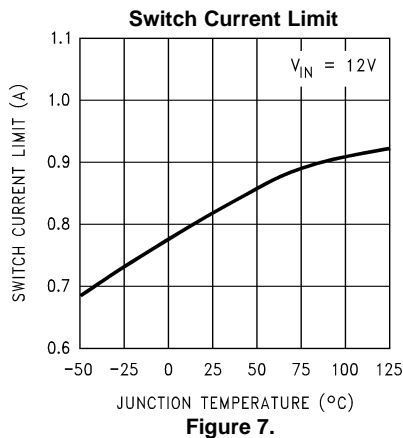

Figure 7.

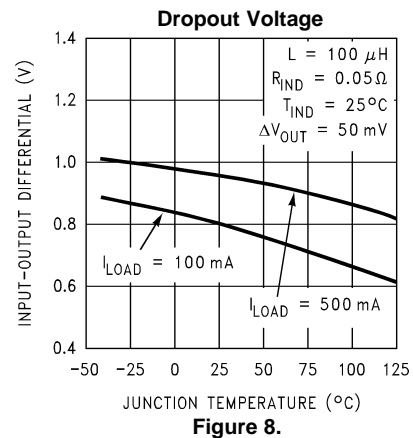

Figure 8.

Typical Performance Characteristics (continued)

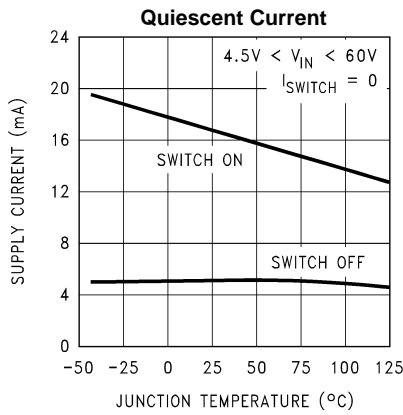

Figure 9.

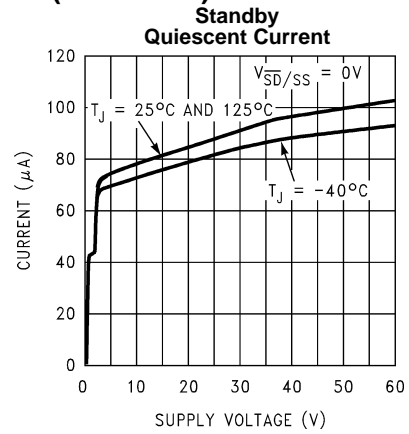

Figure 10.

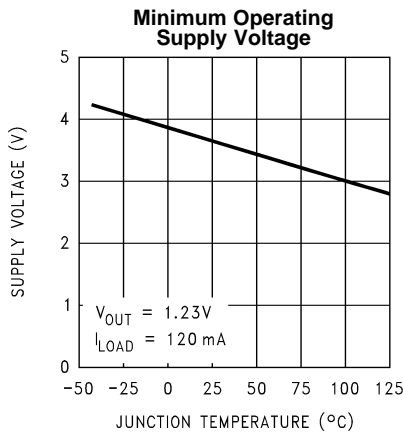

Figure 11.

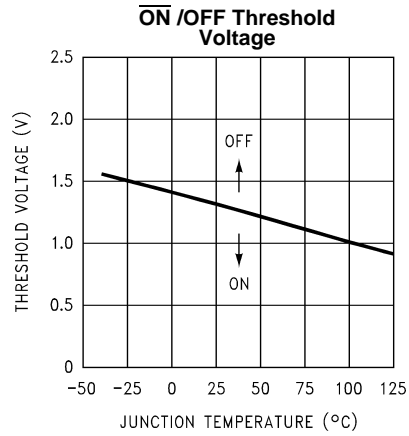

Figure 12.

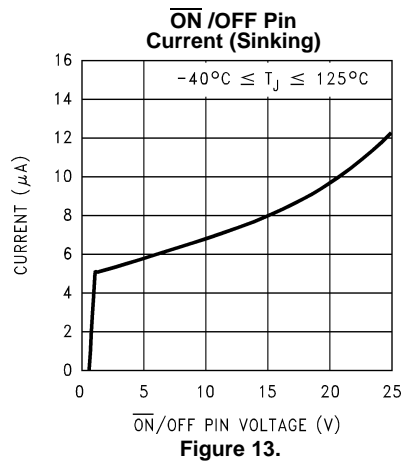

Figure 13.

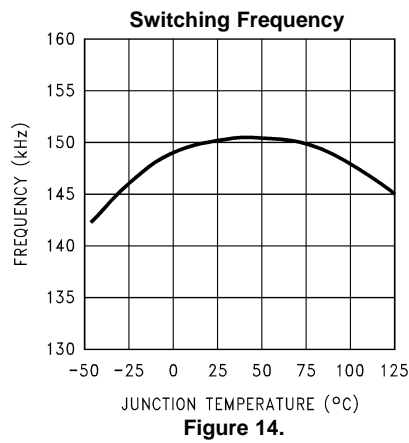
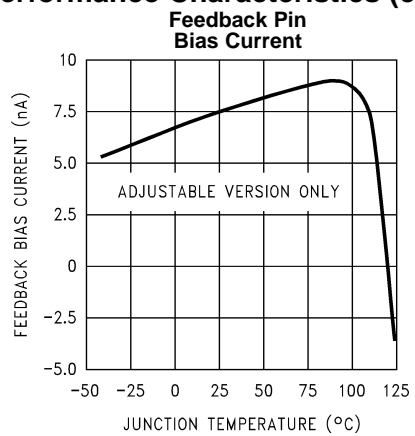

Figure 14.

Typical Performance Characteristics (continued)



TYPICAL CIRCUIT AND LAYOUT GUIDELINES

Fixed Output Voltage Versions

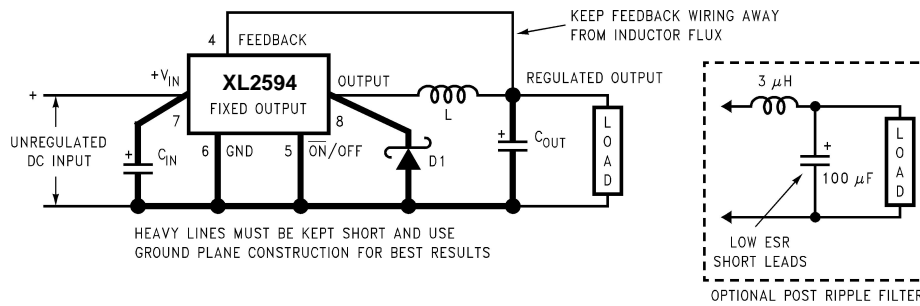

C_{IN} — 68 μF , 35V, Aluminum Electrolytic Nichicon “PL Series”
 C_{OUT} — 120 μF , 25V Aluminum Electrolytic, Nichicon “PL Series”
 D1 — 1A, 40V Schottky Rectifier, 1N5819
 L1 — 100 μH , L20

Select components with higher voltage ratings for designs using the XL2594 with an input voltage between 40V and 60V.

Adjustable Output Voltage Versions

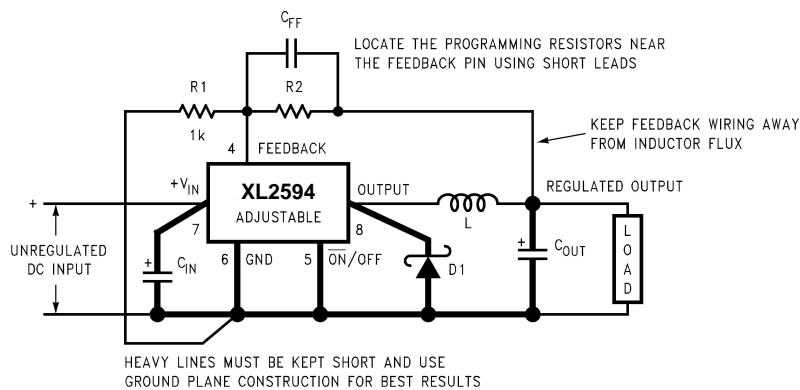

$$V_{OUT} = V_{REF} \left(1 + \frac{R_2}{R_1} \right) \quad \text{where } V_{REF} = 1.23\text{V}$$

$$R_2 = R_1 \left(\frac{V_{OUT}}{V_{REF}} - 1 \right) \quad \text{Select } R_1 \text{ to be approximately } 1 \text{ k}\Omega, \text{ use a } 1\% \text{ resistor for best stability.}$$

C_{IN} — 68 μF , 35V, Aluminum Electrolytic Nichicon “PL Series”
 C_{OUT} — 120 μF , 25V Aluminum Electrolytic, Nichicon “PL Series”
 D1 — 1A, 40V Schottky Rectifier, 1N5819
 L1 — 100 μH , L20
 R_1 — 1 k Ω , 1%
 C_{FF} — See Application Information Section

Figure 16. Typical Circuits and Layout Guides

As in any switching regulator, layout is very important. Rapidly switching currents associated with wiring inductance can generate voltage transients which can cause problems. For minimal inductance and ground loops, the wires indicated by **heavy lines should be wide printed circuit traces and should be kept as short as possible**. For best results, external components should be located as close to the switcher IC as possible using ground plane construction or single point grounding.

If **open core inductors are used**, special care must be taken as to the location and positioning of this type of inductor. Allowing the inductor flux to intersect sensitive feedback, IC groundpath and C_{OUT} wiring can cause problems.

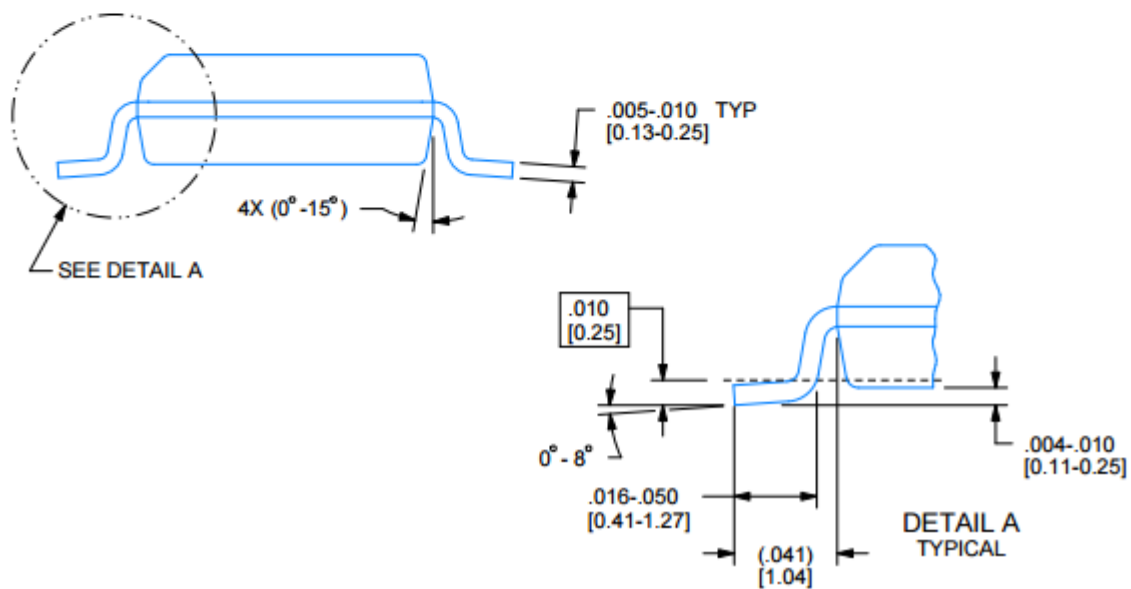
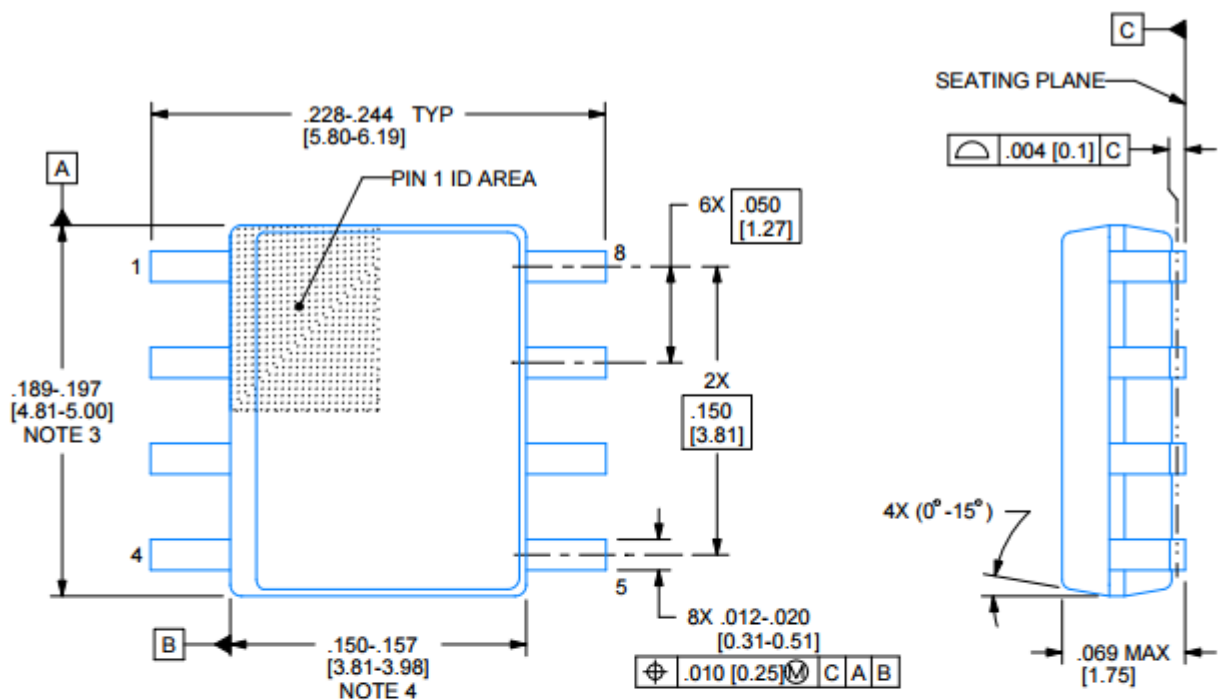

以上信息仅供参考. 如需帮助联系客服人员. 谢谢 XINLUDA

X-ON Electronics

Largest Supplier of Electrical and Electronic Components

Click to view similar products for [Switching Controllers](#) category:

Click to view products by [XINLUDA](#) manufacturer:

Other Similar products are found below :

[LV5065VB-TLM-H](#) [LV5066V-TLM-H](#) [LV5725JAZ-AH](#) [633888R](#) [MP2908AGF](#) [AZ7500EP-E1](#) [NCP1012AP133G](#) [NCP1217P133G](#)
[NCP1218AD65R2G](#) [NCP1234AD100R2G](#) [NCP1244BD065R2G](#) [NCP1336ADR2G](#) [NCP1587GDR2G](#) [NCP6153MNTWG](#)
[NCP81005MNTWG](#) [NCP81101BMNTXG](#) [NCP81205MNTXG](#) [HV9123NG-G-M934](#) [IR35207MTRPBF](#) [ISL6367HIRZ](#) [CAT874-80ULGT3](#)
[SJ6522AG](#) [SJE6600](#) [TLE63893GV50XUMA1](#) [IR35215MTRPBF](#) [SG3845DM](#) [NCP1216P133G](#) [NCP1236DD65R2G](#) [NCP1247BD100R2G](#)
[NCP1250BP65G](#) [NCP4202MNR2G](#) [NCP4204MNTXG](#) [NCP6132AMNR2G](#) [NCP81141MNTXG](#) [NCP81142MNTXG](#) [NCP81172MNTXG](#)
[NCP81203MNTXG](#) [NCP81206MNTXG](#) [NX2155HCUPTR](#) [UC3845ADM](#) [UBA2051C](#) [IR35201MTRPBF](#) [MAX8778ETJ+](#)
[MAX17500AAUB+T](#) [MAX17411GTM+T](#) [MAX16933ATIR/V+](#) [NCP1010AP130G](#) [NCP1063AD100R2G](#) [NCP1216AP133G](#)
[NCP1217AP100G](#)