

Current rating:3A AC/DC  
 额定电流: 3A AC/DC  
 Temperature range:-40°C~+125°C  
 温度范围: -40°C~+125°C

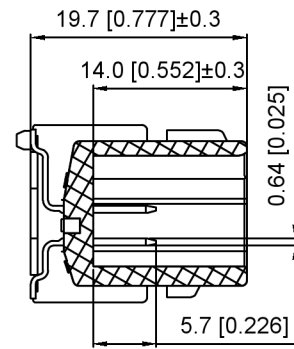

SEC:A-A

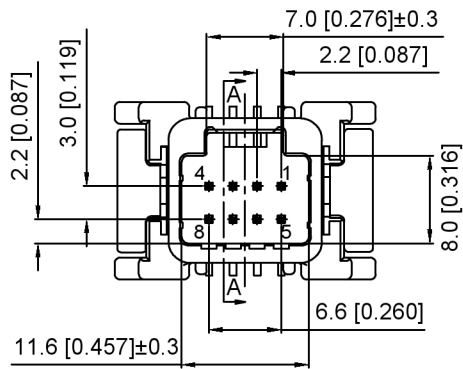
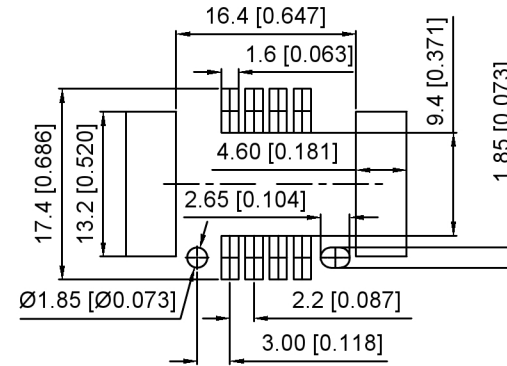

PCB Layout

K 137635 W V S - 2xXX - PS SW  
 ① ② ③ ④ ⑤ ⑥ ⑦ ⑧

- 1.K: XKBTEK-Car Connector
- 2.XKB Series No
- 3.Category:W-Wafer
- 4.Welding Board Range:V-Stright 180°
- 5.Welding Way:S-SMT
- 6.Row No.Pin No:2xXX-2x04 Pin
- 7.Material:PS-PPS (Black color)
- 8.Pating:SW-Matte Tin Plated

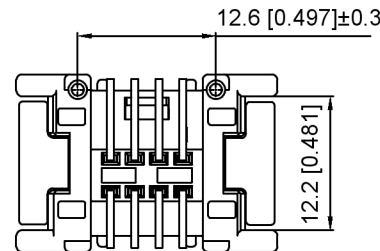
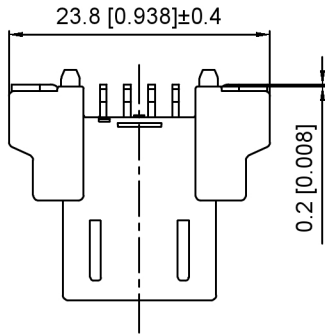

K137635WVS-2xXX-PSSW	PPS	Brass	K137635HM
PART NO	Material	Material(Pin)	Suitable XKB Housing

DSND	SCALE: N/A	MODEL TYPE: 2.2mm Automobile connector
DWN	VIEW:	PART NO.: K137635WVS-2xXX-PSSW
CHKD	UNIT: mm/in	DWG NO.: X-K137635WVS-2xXX-PSSW
APPD	SIZE: A4	

WEIGHT	SHEET	REVISION
	1/1	A0



XKB INDUSTRIAL PRECISION CO.,LIMITED

					ANGLAR	±5°
Δx					L ≤ 4	±0.2
Δx					4 < L ≤ 16	±0.3
Δx					16 < L ≤ 63	±0.4
MARK	DESCRIPTION	DATE	REVISED	APPROVED	L > 63	±0.5
REVISIONS					UNSPECIFIED TOLERANCES	
www.helloxkb.com www.helloxkb.cn www.xk-dg.cn						

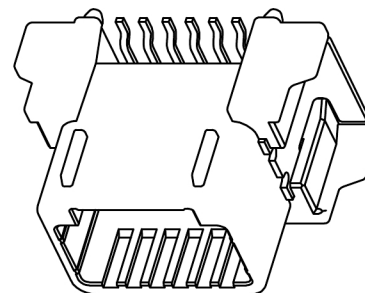
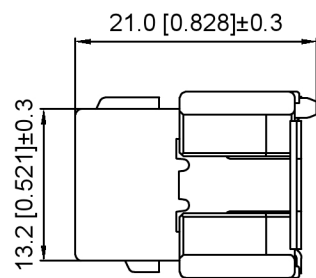
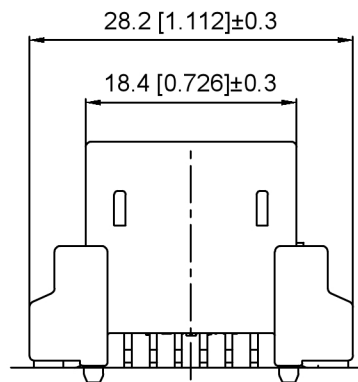

Current rating:3A AC/DC  
 额定电流: 3A AC/DC  
 Temperature range:-40°C-+125°C  
 温度范围: -40°C-+125°C

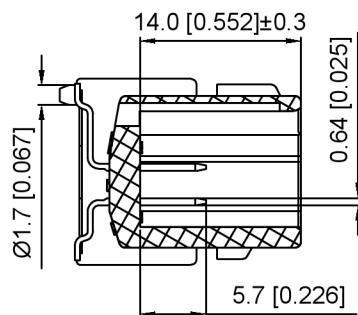
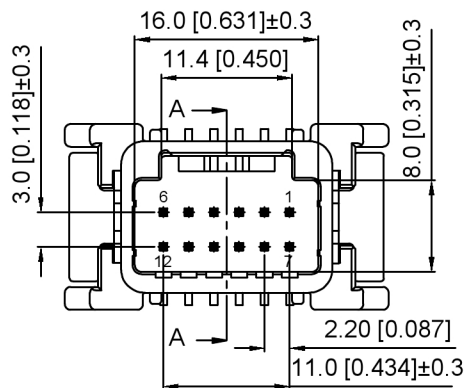

SEC:A-A

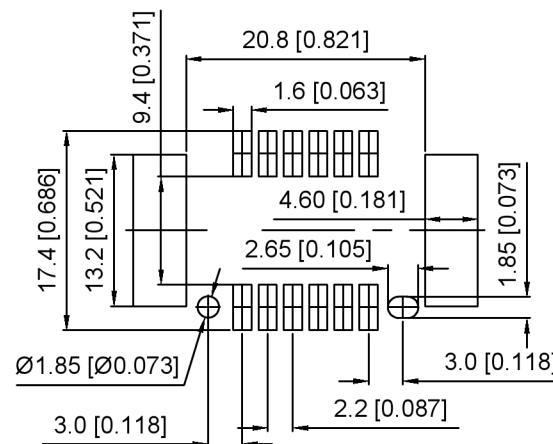

PCB Layout

K 137635 W V S - 2xXX - PS SW  
 ① ② ③ ④ ⑤ ⑥ ⑦ ⑧

- 1.K: XKBTEK-Car Connector
- 2.XKB Series No
- 3.Category:W-Wafer
- 4.Welding Board Range:V-Stright 180°
- 5.Welding Way:S-SMT
- 6.Row No.Pin No:2xXX-2x06 Pin
- 7.Material:PS-PPS (Black color)
- 8.Palting:SW-Matte Tin Plated

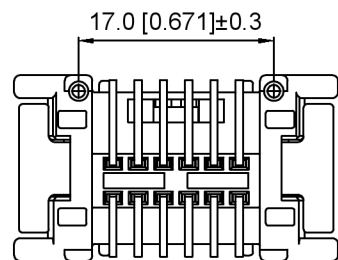
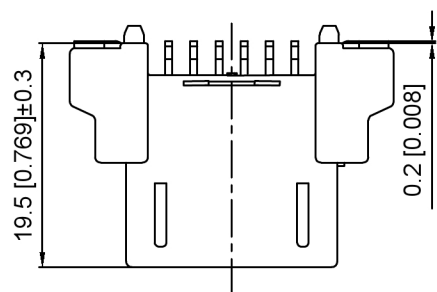

K137635WVS-2xXX-PSSW	PPS	Brass	K137635HM
PART NO	Material	Material(Pin)	Suitable XKB Housing

DSND	SCALE: N/A	MODEL TYPE: 2.2mm Automobile connector
DWN	VIEW:	PART NO.: K137635WVS-2xXX-PSSW
CHKD	UNIT: mm/in	DWG NO.: X-K137635WVS-2xXX-PSSW
APPD	SIZE: A4	WEIGHT SHEET REVISION
		1/1 A0



XKB INDUSTRIAL PRECISION CO.,LIMITED

ANGLAR	±5°
L ≤ 4	±0.2
4 < L ≤ 16	±0.3
16 < L ≤ 63	±0.4
L > 63	±0.5
UNSPECIFIED TOLERANCES	

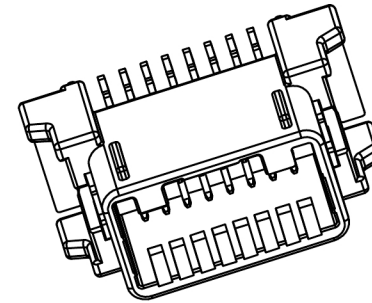
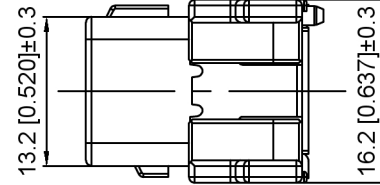
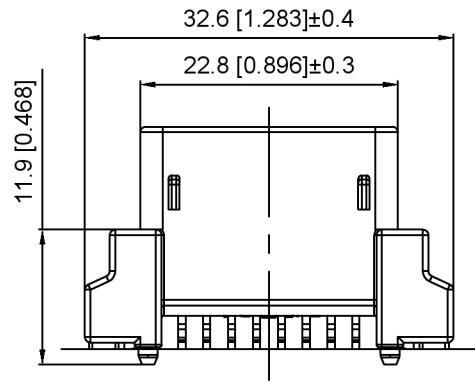

Current rating: 3A AC/DC  
 额定电流: 3A AC/DC  
 Temperature range: -40°C~+125°C  
 温度范围: -40°C~+125°C

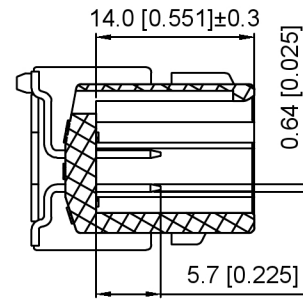
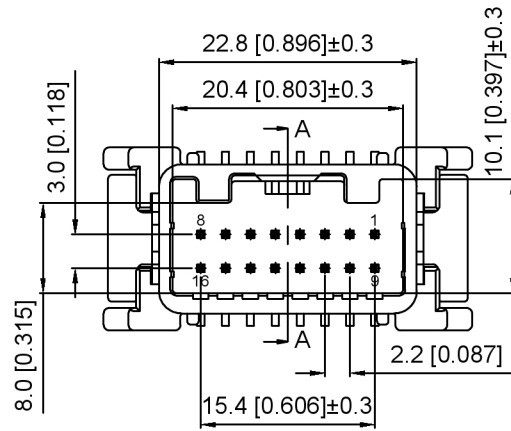

SEC:A-A

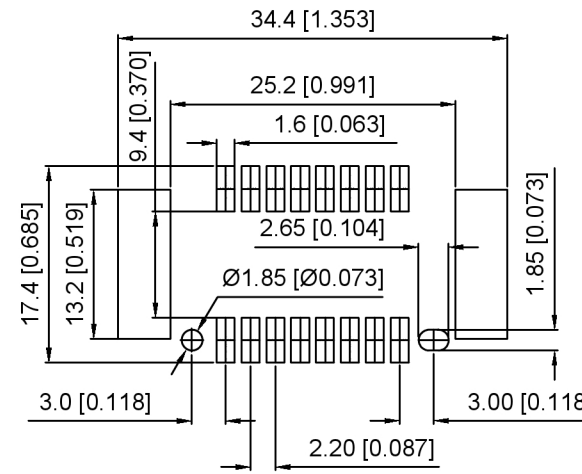

PCB Layout

K 137635 W V S - 2xXX - PS SW  
 ① ② ③ ④ ⑤ ⑥ ⑦ ⑧

- 1.K: XKBTEK-Car Connector
- 2.XKB Series No
- 3.Category:W-Wafer
- 4.Welding Board Range:V-Stright 180°
- 5.Welding Way:S-SMT
- 6.Row No.Pin No:2xXX-2x08 Pin
- 7.Material:PS-PPS (Black color)
- 8.Palting:SW-Matte Tin Plated

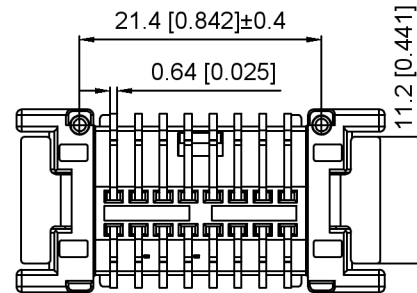
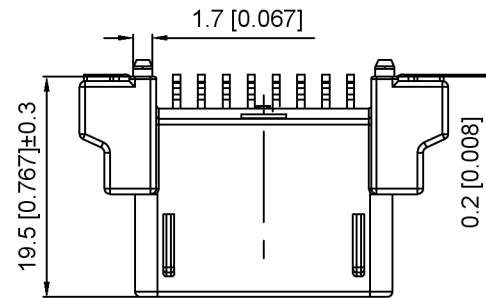

K137635WVS-2xXX-PSSW	PPS	Brass	K137635HM
PART NO	Material	Material(Pin)	Suitable XKB Housing

DSND	SCALE: N/A	MODEL TYPE: 2.2mm Automobile connector
DWN	VIEW:	PART NO.: K137635WVS-2xXX-PSSW
CHKD	UNIT: mm/in	DWG NO.: X-K137635WVS-2xXX-PSSW
APPD	SIZE: A4	WEIGHT SHEET REVISION 1/1 A0



XKB INDUSTRIAL PRECISION CO., LIMITED

					ANGLAR	±5°
ΔX					L ≤ 4	±0.2
ΔX					4 < L ≤ 16	±0.3
ΔX					16 < L ≤ 63	±0.4
MARK	DESCRIPTION	DATE	REVISED	APPROVED	L > 63	±0.5
REVISIONS					UNSPECIFIED TOLERANCES	

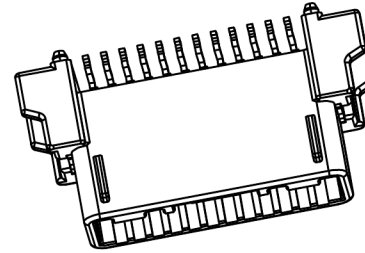
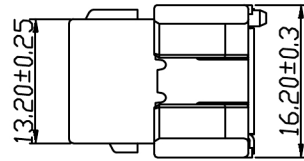
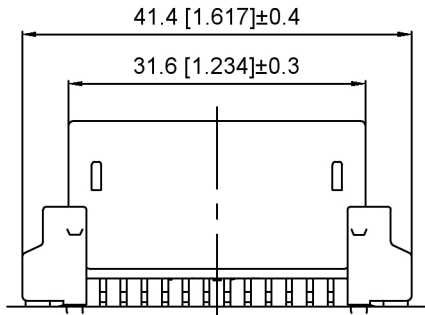

Current rating: 3A AC/DC  
 额定电流: 3A AC/DC  
 Temperature range: -40°C-+125°C  
 温度范围: -40°C-+125°C

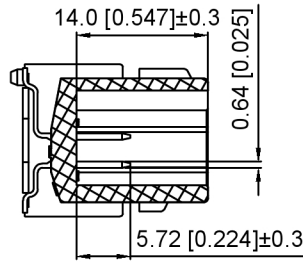
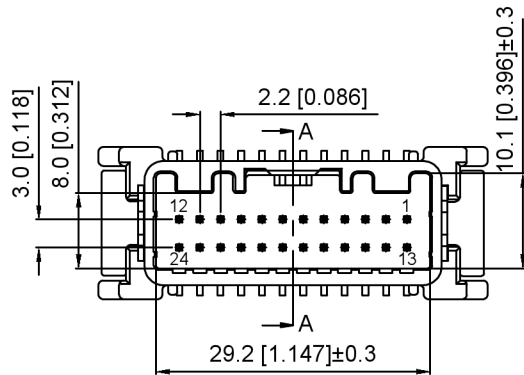

SEC:A-A

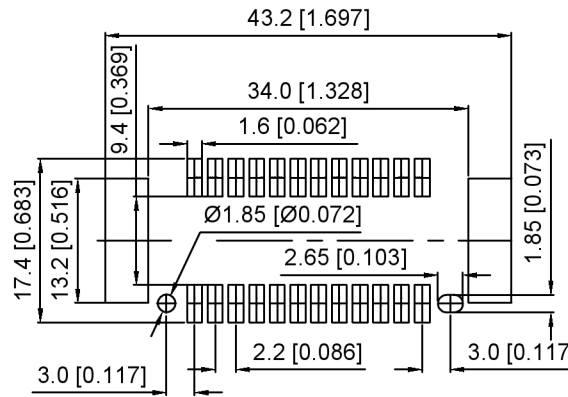

PCB Layout

K 137635 W V S - 2xXX - PS SW  
 ① ② ③ ④ ⑤ ⑥ ⑦ ⑧

- 1.K: XKBTEK-Car Connector
- 2.XKB Series No
- 3.Category:W-Wafer
- 4.Welding Board Range:V-Stright 180°
- 5.Welding Way:S-SMT
- 6.Row No.Pin No:2xXX-2x12 Pin
- 7.Material:PS-PPS (Black color)
- 8.Palting:SW-Matte Tin Plated

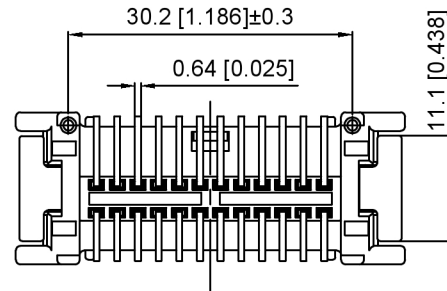
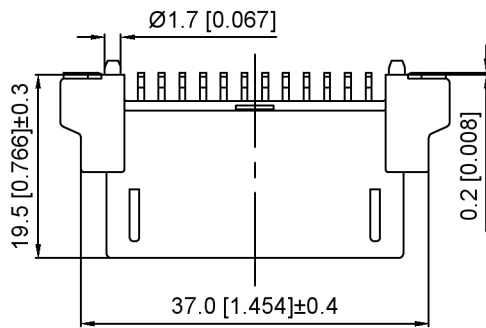

K137635WVS-2xXX-PSSW	PPS	Brass	K137635HM
PART NO	Material	Material(Pin)	Suitable XKB Housing

DSND	SCALE: N/A	MODEL TYPE:
DWN	VIEW:	2.2mm Automobile connector
CHKD	UNIT: mm/in	PART NO.:
APPD	SIZE: A4	K137635WVS-2xXX-PSSW
		DWG NO.:
		X-K137635WVS-2xXX-PSSW
WEIGHT	SHEET	REVISION
	1/1	A0



XKB INDUSTRIAL PRECISION CO., LIMITED

ANGLAR	±5°
L ≤ 4	±0.2
4 < L ≤ 16	±0.3
16 < L ≤ 63	±0.4
L > 63	±0.5
UNSPECIFIED TOLERANCES	

REVISIONS

DESCRIPTION

DATE

REVISED

APPROVED

Δx				
Δx				
Δx				
MARK				

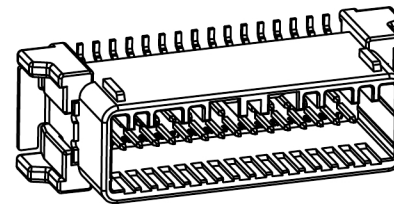
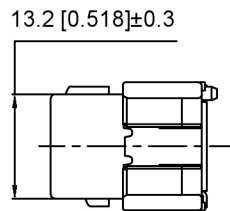
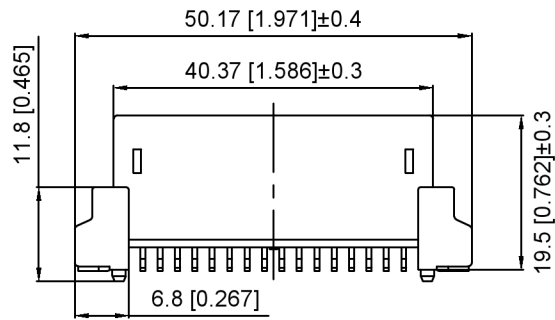

Current rating:3A AC/DC  
 额定电流: 3A AC/DC  
 Temperature range:-40°C~+245°C  
 温度范围: -40°C~+245°C

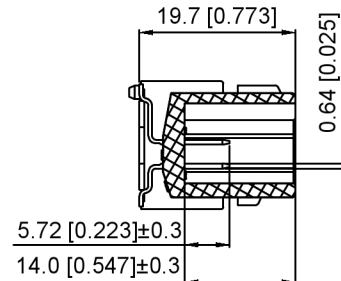
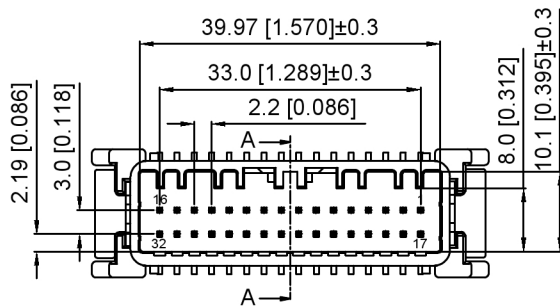

SEC:A-A

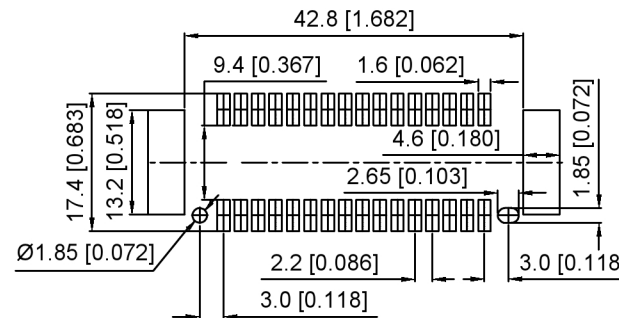

PCB Layout

K 137635 W V S - 2xXX - PS SW  
 ① ② ③ ④ ⑤ ⑥ ⑦ ⑧

- 1.K: XKBTEK-Car Connector
- 2.XKB Series No
- 3.Category:W-Wafer
- 4.Welding Board Range:V-Stright 180°
- 5.Welding Way:S-SMT
- 6.Row No.Pin No:2xXX-2x16 Pin
- 7.Material:PS-PPS+GF40% (Black color)
- 8.Palting:SW-Matte Tin Plated

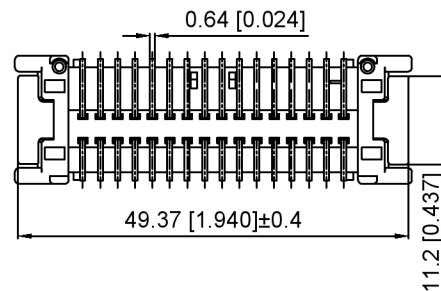
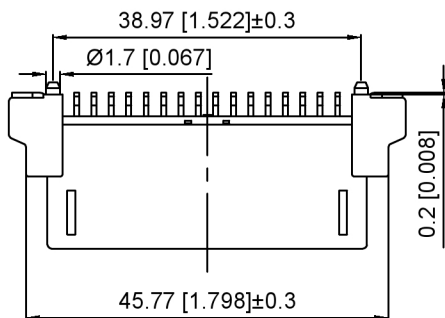

K137635WVS-2xXX-PSSW	PPS	Brass	K137635HM
PART NO	Material	Material(Pin)	Suitable XKB Housing

DSND	SCALE: N/A	MODEL TYPE: 2.2mm Automobile connector
DWN	VIEW:	PART NO.: K137635WVS-2xXX-PSSW
CHKD	UNIT: mm/in	DWG NO.: X-K137635WVS-2xXX-PSSW
APPD	SIZE: A4	WEIGHT SHEET REVISION



XKB INDUSTRIAL PRECISION CO.,LIMITED

WEIGHT	SHEET	REVISION
	1/1	A0

					ANGLAR	±5°
ΔX					L ≤ 4	±0.2
ΔX					4 < L ≤ 16	±0.3
ΔX					16 < L ≤ 63	±0.4
MARK	DESCRIPTION	DATE	REVISED	APPROVED	L > 63	±0.5
REVISIONS					UNSPECIFIED TOLERANCES	

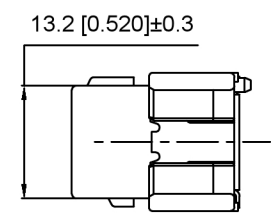
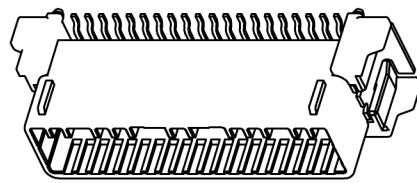
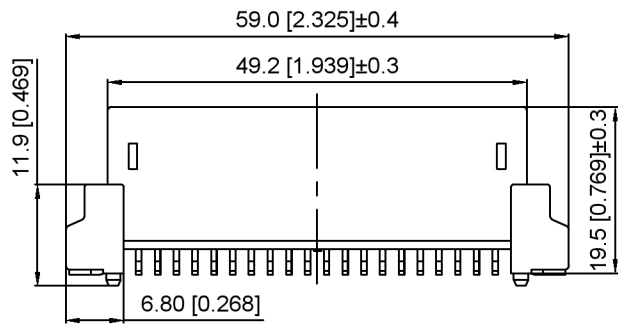

Current rating: 3A AC/DC  
 额定电流: 3A AC/DC  
 Temperature range: -40°C~+245°C  
 温度范围: -40°C~+245°C

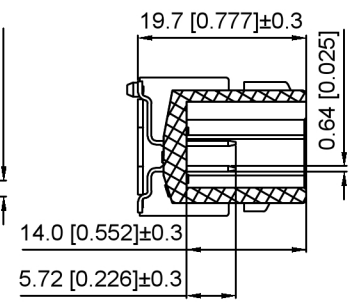
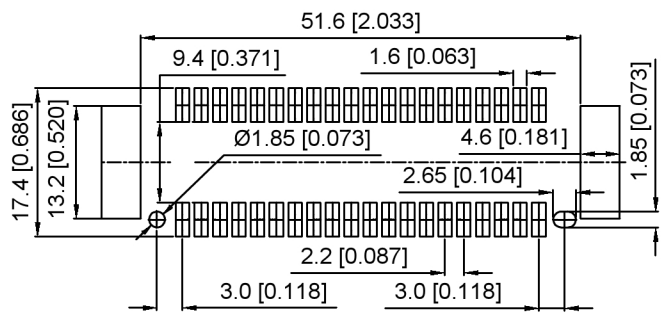
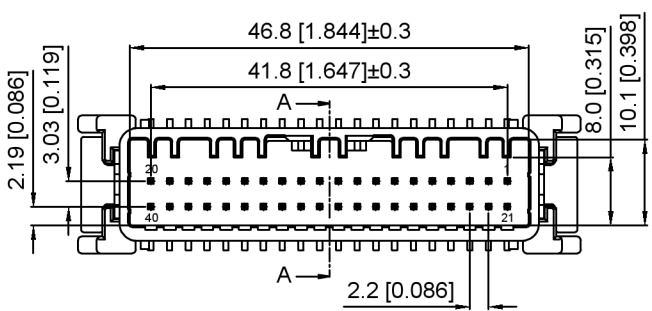

K 137635 W V S - 2xXX - PS SW  
 ① ② ③ ④ ⑤ ⑥ ⑦ ⑧

- 1.K: XKBTEK-Car Connector
- 2.XKB Series No
- 3.Category:W-Wafer
- 4.Welding Board Range:V-Stright 180°
- 5.Welding Way:S-SMT
- 6.Row No.Pin No:2xXX-2x20 Pin
- 7.Material:PS-PPS+GF40% (Black color)
- 8.Palting:SW-Matte Tin Plated

PCB Layout

SEC:A-A

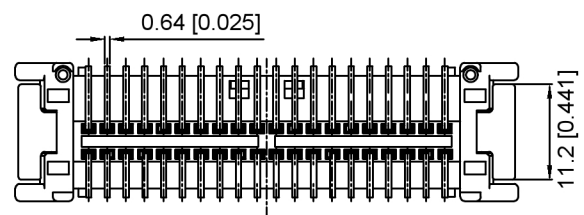
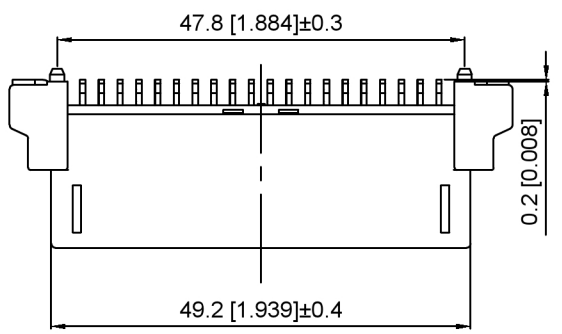

K137635WVS-2xXX-PSSW	PPS	Brass	K137635HM
PART NO	Material	Material(Pin)	Suitable XKB Housing

DSND	SCALE: N/A	MODEL TYPE:		
DWN	VIEW:	2.2mm Automobile connector		
CHKD	UNIT: mm/in	PART NO.:		
APPD	SIZE: A4	K137635WVS-2xXX-PSSW		
		DWG NO.:		
		X-K137635WVS-2xXX-PSSW		
		WEIGHT	SHEET	REVISION
			1/1	A0



XKB INDUSTRIAL PRECISION CO., LIMITED

					ANGLAR	±5°
ΔX					L ≤ 4	±0.2
ΔX					4 < L ≤ 16	±0.3
ΔX					16 < L ≤ 63	±0.4
MARK					L > 63	±0.5
REVISIONS						UNSPECIFIED TOLERANCES
www.helloxkb.com www.helloxkb.cn www.xk-dg.cn						

## X-ON Electronics

Largest Supplier of Electrical and Electronic Components

*Click to view similar products for [Automotive Connectors](#) category:*

*Click to view products by [XKB](#) manufacturer:*

Other Similar products are found below :

[003-018-000](#) [60993906-B](#) [72.330.1035.1](#) [776880-1](#) [827153-1](#) [9-1326729-8](#) [9-221607-5](#) [925474-1](#) [928905-1](#) [964562-4](#) [968782-1](#) [12004468](#)  
[12004475-L](#) [12004483](#) [12052466](#) [12066163](#) [12015909](#) [12077753](#) [1-21030-1](#) [12047957](#) [12047958](#) [12084688](#) [12185550](#) [12336-12](#) [1-](#)  
[326211-1](#) [13681974](#) [13688972](#) [13755420](#) [13779834](#) [13783086](#) [13843152](#) [13522378](#) [13581967](#) [13669624](#) [13675513](#) [13753471](#) [13946876](#)  
[13953457](#) [13955963](#) [13964573](#) [13971791](#) [13790534-L](#) [13797473](#) [13805590](#) [13888202](#) [1428188-1](#) [1437287-3](#) [1428188-2](#) [DS07-19S-5020](#)  
[1456983-5](#)