

Specification:  
 Volatage Rating:250V AC/DC  
 Current Rating :3A AC/DC  
 Withstaning Voltage:800V AC/Minute  
 Temperature Range:-40°~+125°  
 Insulation Resistance:≥1000MΩ  
 Contact Resistance:≤10MΩ

K 201900 L - XX - PT  
 ① ② ③ ④ ⑤

- 1.K:XKBTEK-Car Connector
- 2.XKB Series No
- 3.Special No:L-Lock catch
- 4.Row No.Pin No:XX-02~05
- 5.Material:PT-PBT

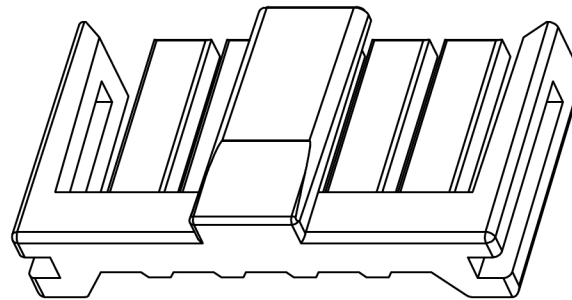
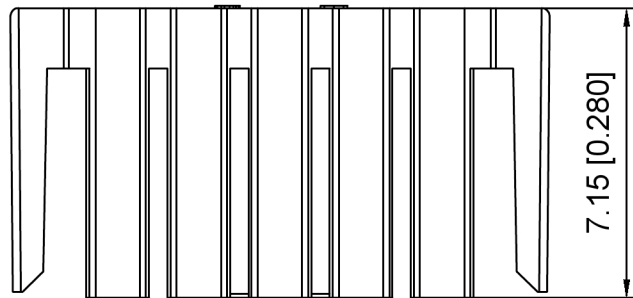
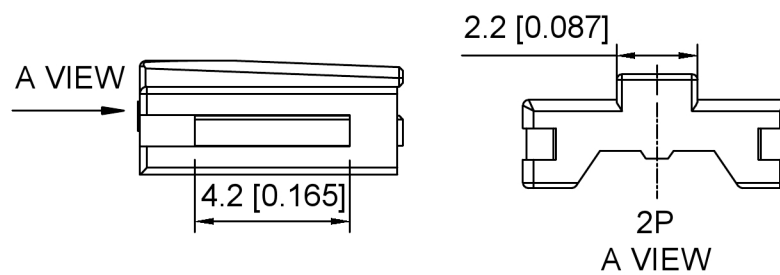
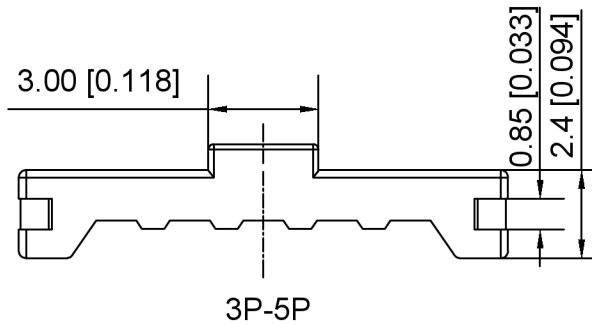

Poles	Dimensions(mm)	
	A	B
02	2.0	7.3
03	4.0	9.3
04	6.0	11.3
05	8.0	13.3

K201900L-XX-PT	PBT	K201900HM	K201900W
PART NO	Material	Suitable XKB Housing	Suitable XKB Wafer

DSND	SCALE: N/A	MODEL TYPE: 2.0mm automotive connector
DWN	VIEW:	PART NO.: K201900L-XX-PT
CHKD	UNIT: mm/in	DWG NO.: X-K201900L-XX-PT
APPD	SIZE: A4	

**XKIB**

XKB INDUSTRIAL PRECISION CO.,LIMITED

WEIGHT	SHEET	REVISION
	1/1	A0

MARK	DESCRIPTION	DATE	REVISED	APPROVED	UNSPECIFIED TOLERANCES
ΔX					ANGLAR ±5°
ΔX					L ≤ 4 ±0.2
ΔX					4 < L ≤ 16 ±0.3
					16 < L ≤ 63 ±0.4
					L > 63 ±0.5

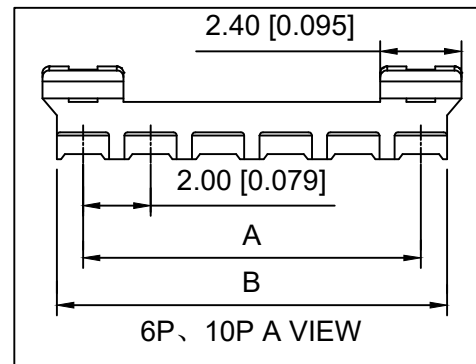
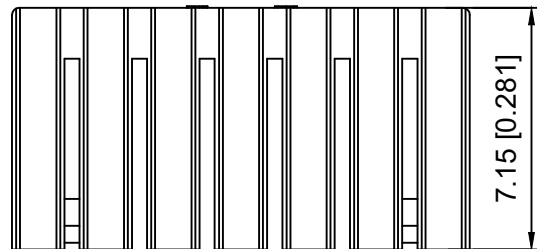
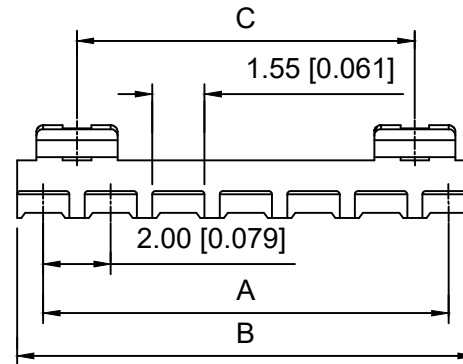
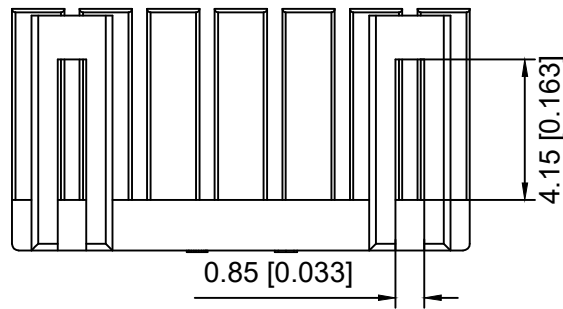
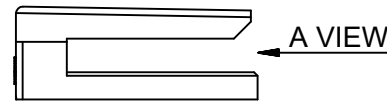
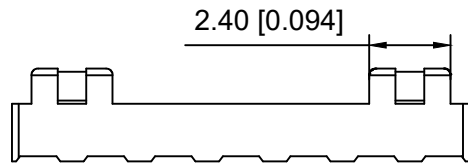

Specification:  
 Volatage Rating:250V AC/DC  
 Current Rating :3A AC/DC  
 Withstaning Voltage:800V AC/Minute  
 Temperature Range:-40°~+125°  
 Insulation Resistance:≥1000MΩ  
 Contact Resistance:≤10MΩ

K 201900 L - XX - 4T  
 ① ② ③ ④ ⑤

- 1.K:XKBTEK-Car Connector
- 2.XKB Series No
- 3.Special No:L-Lock catch
- 4.Row No.Pin No:XX-06~15 Pin
- 5.Material:4T-PA4T

Poles	Dimensions(mm)			Poles	Dimensions(mm)		
	A	B	C		A	B	C
06	10.00	11.55	10.00	11	20.00	21.55	17.40
07	12.00	13.55	10.00	12	22.00	23.55	17.40
08	14.00	15.55	10.00	13	24.00	25.55	17.40
09	16.00	17.55	12.00	14	26.00	27.55	17.40
10	18.00	19.55	17.40	15	28.00	29.55	17.40

K201900L-XX-4T	PA4T	K201900HM	X2000W
PART NO	Material	Suitable XKB Housing	Suitable XKB Wafer

DSND		SCALE: N/A	MODEL TYPE:
DWN		VIEW:	2.0mm automotive connector
CHKD		UNIT: mm/in	PART NO.:
APPD		SIZE: A4	K201900L-XX-4T
			DWG NO.:
			X-K201900L-XX-4T
WEIGHT		SHEET	REVISION
		1/1	A0

MARK	DESCRIPTION	DATE	REVISED	APPROVED	UNSPECIFIED TOLERANCES
					ANGLAR ±5°
ΔX					L ≤ 4 ±0.2
ΔX					4 < L ≤ 16 ±0.3
ΔX					16 < L ≤ 63 ±0.4
					L > 63 ±0.5



XKB INDUSTRIAL PRECISION CO., LIMITED

## X-ON Electronics

Largest Supplier of Electrical and Electronic Components

*Click to view similar products for [Headers & Wire Housings](#) category:*

*Click to view products by [XKB](#) manufacturer:*

Other Similar products are found below :

[57102-F02-18ULF](#) [58102-G61-06LF](#) [582553-1](#) [009176003701906](#) [01.001.5753.1](#) [0050291907](#) [02.125.8002.8](#) [609-3404](#) [61062-3](#)  
[CSU011177004](#) [622-0430](#) [622-3653LF](#) [63453-116](#) [636-1030](#) [636-1427](#) [636-3427](#) [636-4007](#) [641938-9](#) [644827-2](#) [65495-038](#) [65692-001LF](#)  
[65781-018](#) [65781-047](#) [65817-010LF](#) [65817-015LF](#) [66207-023LF](#) [67095-007LF](#) [67601157](#) [68631-112](#) [68645-018](#) [699319-000](#)  
[M90C108951C](#) [70.362.1628.0](#) [70-4210](#) [70-4226B](#) [70-4853B](#) [707-5028](#) [71.350.2428.0](#) [71961-016LF](#) [733-134](#) [733-162](#) [754199-000](#) [760-](#)  
[3052](#) [80.063.4001.1](#) [800-90-001-10-001000](#) [800-90-010-10-002000](#) [801-43-002-10-013000](#) [801-43-006-10-002000](#) [803-41-018-10-001000](#)  
[803-43-024-10-001000](#)