

Pin #	SIGNAL NAME	DESCRIPTION	MATING SEQUENCE
1	VBUS	POWER	SECOND
2	D-	USB 2.0 DIFFERENTIAL PAIR	THIRD
3	D+		
4	GND	GROUND FOR POWER RETURN	SECOND
5	StdA_SSRX-	SUPERSPEED RECEIVER DIFFERENTIAL PAIR	LAST
6	StdA_SSRX+		
7	GND_DRAIN	GROUND FOR SIGNAL RETURN	
8	StdA_SSTX-	SUPERSPEED TRANSMITTER DIFFERENTIAL PAIR	
9	StdA_SSTX+		
Shell	Shield	CONNECTOR METAL SHELL	FRIST

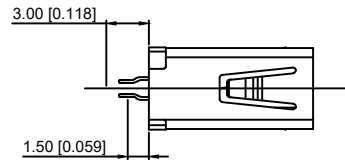
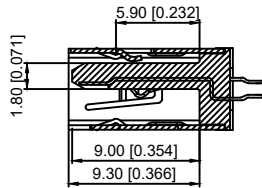
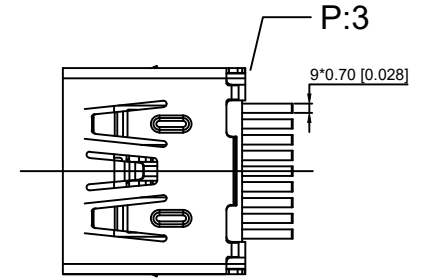
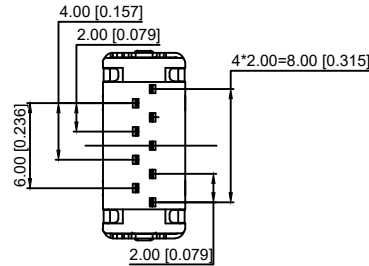
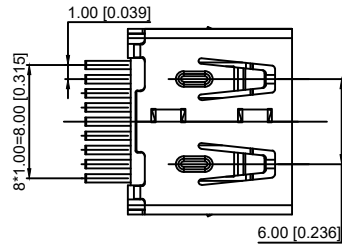
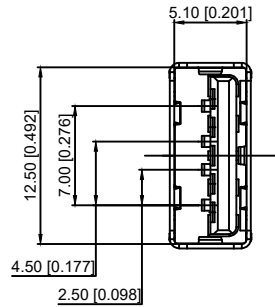
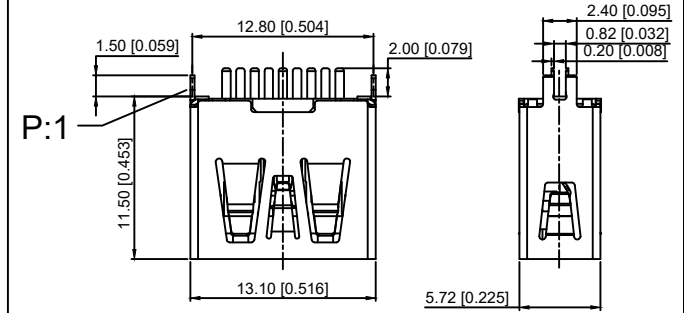
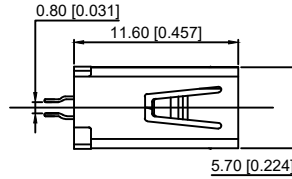

Material
Housing Material: LCP, UL94V-0, blue
Contact Terminal: Brass
Metallic Shell: Spcc
Plating
Underplating: Nickel
Contact Plating: 1µ" Gold
Solder Tail: 100µ" Min. Tin
Metallic Shell: Nickel

Electrical
Voltage Rating: 100 V AC
Current Rating: 0.25A (Signal pins 2,3,5,6,7,8,9) 1.8A (Power Pins 1,4)
Contact Resistance: 30mΩ Max.
Insulation resistance: 1000MΩ Min.
Dielectric withstanding voltage: 100V AC/Minute
Mechanical
Durability: 1500 cycles
Mating Force: 35N (3.57Kgf) Max
Unmating Force: 10N (1.02Kgf) Min. initial, 8N min after test
Environmental and Processing
Operating Temperature: -40°C to +85°C

U233-09XN-XBLPC17-X 1

1:Au 1U"
5:Au 15U"
6:Au 30U"
T:TIN
N:NICKEL
1:SPCC
P:1 P:3
B:BLACK W:WHITE BL:BLUE
1:PBT
2:PA6T
3:PA9T
4:LCP

DSND	DATE	SCALE: N/A	MODEL TYPE: USB 3.0
DWN	DATE	VIEW:	PART NO.:
CHKD	DATE	UNIT: mm/in	DWG NO.:
APPD	DATE	SIZE: A4	U233-09XN-XBLPC17-X1
XKB INDUSTRIAL PRECISION CO., LIMITED			WEIGHT 1.0g
			SHEET 1/1
			REVISION A0

ΔX	DESCRIPTION	DATE	REVISED	APPROVED	ANGLAR	±5°
ΔX					L ≤ 4	±0.2
ΔX					4 < L ≤ 16	±0.3
ΔX					16 < L ≤ 63	±0.4
MARK					L > 63	±0.5
REVISIONS						UNSPECIFIED TOLERANCES

X-ON Electronics

Largest Supplier of Electrical and Electronic Components

Click to view similar products for [USB Connectors](#) category:

Click to view products by [XKB](#) manufacturer:

Other Similar products are found below :

[950](#) [A-USB B-TOP-C](#) [MUSBA511N5](#) [MUSBC111M5](#) [MUSBD11135](#) [17-200721](#) [217450-1](#) [KMBVX-TH-5S-B30](#) [896-30-004-00-000000](#)
[KUSBX-AS2N-W](#) [KUSBX-SMT2AP1S-W30](#) [935](#) [957](#) [30-498-6](#) [SK-60A-2](#) [1734082-1](#) [30-1574](#) [30-470](#) [30-489](#) [30-541](#) [A-USB A-2P-C](#)
[MIKROE-1451](#) [USBFTV2PEM2G](#) [USBFTVSCCG](#) [4689-1](#) [1-1734084-2](#) [MUSBC11135](#) [USBF21ZNSCC](#) [USBBFTV6ZC](#) [MUSBB151341](#)
[10135326-001LF](#) [M9177/3-1](#) [TJ-105](#) [USB-A-S-F-B-VT](#) [4198](#) [690-024-633-031](#) [UB-20PMFP-LC7001](#) [USBFTVC6MRG](#) [UA-20BMFA-](#)
[SL8001](#) [17-200011](#) [USBFTVC7ZC](#) [UB-20AFMM-LL7A01](#) [USBFTVC2MN](#) [CAP-WCCMLPB1](#) [1310-1031-01](#) [2041386-1](#) [2274475-3](#) [UB-](#)
[20BMFA-SL8001](#) [UB-20PMFP-SC8003](#) [914-614A2025S10200](#)