

SECT B-B

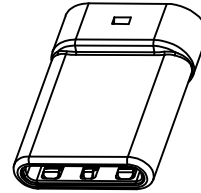

P/N	R/C
U261-24XXN-4B0281	C(10nF/30V MIN)
U261-24XXN-4B0165	C(10nF/30V MIN)+RD(5.1KΩ)
U261-24XXN-4B0174	C(10nF/30V MIN)+RP(56KΩ)

U261-24XXN-4B0281

C TYPE PLUG:

PCB:

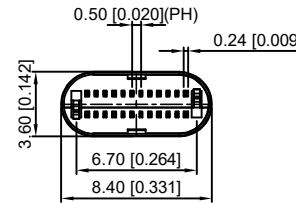
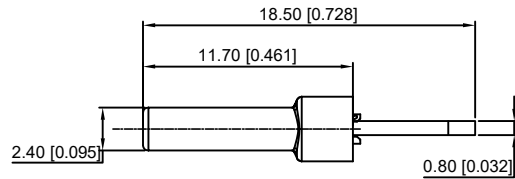
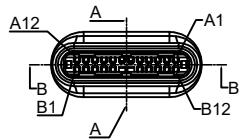
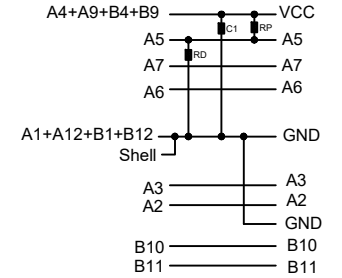
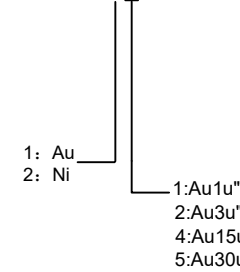

REMARKS:

1. CONTACT INSERTION AND WITHDRAW FORCE :

1. Insertion force : 5N-20N max.
2. Withdrawal force : 8N-20N.
3. Durability : 10000Cycles.

2. ELECTRIC PROPERTY :

1. Contact current rating : 3A.
2. Dielectric Strength : 100V AC(RMS).
3. Insulation Resistance : 100 megaohms min.
4. Contact resistance : 40m0hms MAX.FOR VBUS,GND AND OTHER CONTACT 50m0hms MAX.AFTER ENVIRONMENT TEST

3. AMBIENT TEMPERATURE :

1. Operating temperature : -55°C to +85°C.

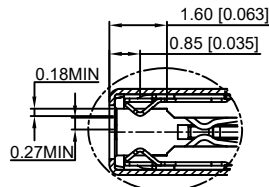
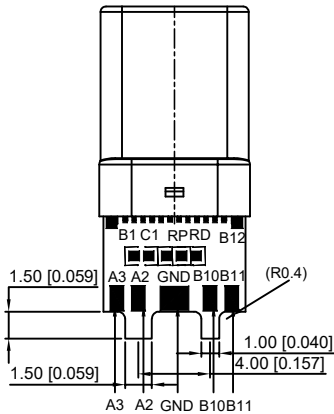

D
2:1

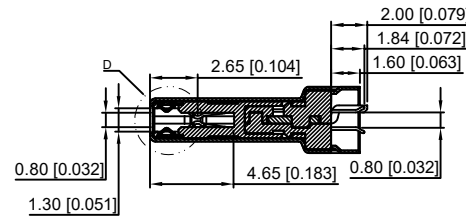

SECT A-A

A12	A11	A10	A9	A8	A7	A6	A5	A4	A3	A2	A1
GND	RX2+	RX2-	Vbus	SBU1	D-	D+	CC	Vbus	TX1-	TX1+	GND
GND	TX2+	TX2-	Vbus	Vconn			SBU2	Vbus	RX1-	RX1+	GND
B1	B2	B3	B4	B5	B6	B7	B8	B9	B10	B11	B12

6	Shrapnel	SUS T=0.10mm	
5	Shell	SUS T=0.15mm	Ovep-plating: Ni
4	Terminal	C7025 T=0.15mm	Ovep-plating: Au Ni/Sn
3	Latch	SUS T=0.4mm	
2	Housing	LCP	UL94-0
1	Housing Stopper	LCP	UL94-0
ITEM	DESCRIPTION	MATERIAL	REMARKS

MARK	DESCRIPTION	DATE	REVISED	APPROVED	UNSPECIFIED TOLERANCES	DSND	DATE	SCALE: N/A	MODEL TYPE: 3.1 TYPE C
Δx					ANGLAR ±5°	DWN	DATE	VIEW:	PART NO.:
Δx					L ≤ 4 ±0.2	CHKD	DATE	UNIT: mm/in	DWG NO.:
Δx					4 < L ≤ 16 ±0.3	APPD	DATE	SIZE: A4	U261-24XXN-4B0281
Δx					16 < L ≤ 63 ±0.4				WEIGHT 1.0g
Δx					L > 63 ±0.5				SHEET 1/1
									REVISION A0

www.xk-dg.cn www.helloxkb.com www.helloxkb.cn

XKB INDUSTRIAL PRECISION CO., LIMITED

X-ON Electronics

Largest Supplier of Electrical and Electronic Components

Click to view similar products for [USB Connectors](#) category:

Click to view products by [XKB](#) manufacturer:

Other Similar products are found below :

[950](#) [A-USB B-TOP-C](#) [MUSBA511N5](#) [MUSBC111M5](#) [MUSBD11135](#) [17-200721](#) [217450-1](#) [KMBVX-TH-5S-B30](#) [896-30-004-00-000000](#)
[KUSBX-AS2N-W](#) [KUSBX-SMT2AP1S-W30](#) [935](#) [957](#) [30-498-6](#) [SK-60A-2](#) [1734082-1](#) [30-1574](#) [30-470](#) [30-489](#) [30-541](#) [30-572-3](#) [A-USB](#)
[A-2P-C](#) [MIKROE-1451](#) [USBFTV2PEM2G](#) [USBFTVSCCG](#) [4689-1](#) [1-1734084-2](#) [MUSBC11135](#) [USBF21ZNSCC](#) [USBBFTV6ZC](#)
[MUSBB151341](#) [10135326-001LF](#) [M9177/3-1](#) [TJ-105](#) [USB-A-S-F-B-VT](#) [4198](#) [690-024-633-031](#) [UB-20PMFP-LC7001](#) [USBFTVC6MRG](#)
[UA-20BMFA-SL8001](#) [17-200011](#) [USBFTVC7ZC](#) [UB-20AFMM-LL7A01](#) [USBFTVC2MN](#) [CAP-WCCMLPB1](#) [1310-1031-01](#) [2041386-1](#)
[2274475-3](#) [UB-20BMFA-SL8001](#) [UB-20PMFP-SC8003](#)