

SECT B-B

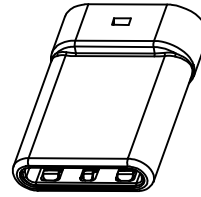

U261-24XXN-4B0417

C TYPE PLUG:

PCB:

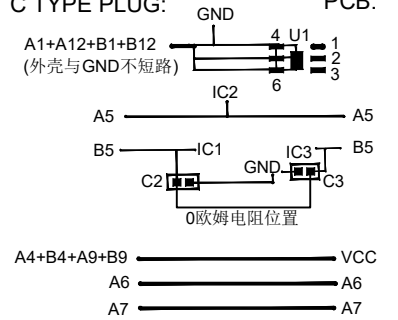

- 1: Au
- 2: Ni
- 1:Au1u"
- 2:Au3u"
- 4:Au15u"
- 5:Au30u"

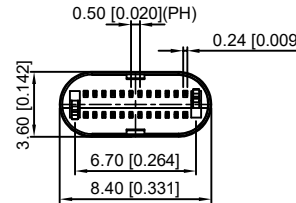
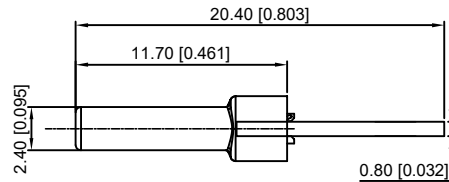
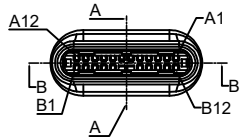

REMARKS:

- 1.CONTACT INSERTION AND WITHDRAW FORCE:
 - 1.Insertion force: 5N-20N max.
 2. Withdrawal force: 8N-20N.
 - 3.Durability : 10000Cycles.
- 2.ELECTRIC PROPERTY:
 - 1.Contact current rating: 3A.
 - 2.Dielectric Strength: 100V AC(RMS).
 - 3.Insulation Resistance: 100 megaohms min.
 - 4.Contact resistance: 40mohms MAX.FOR VBUS,GND AND OTHER CONTACT 50mohms MAX.AFTER ENVIRONMENT TEST
- 3.AMBIENT TEMPERATURE:
 - 1.Operating temperature: -55°C to +85°C.

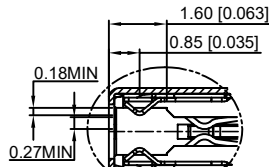
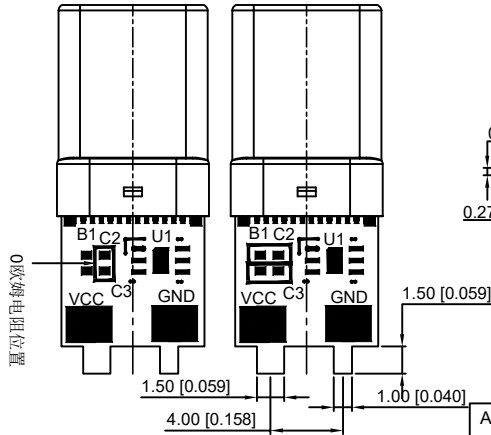

D
2:1

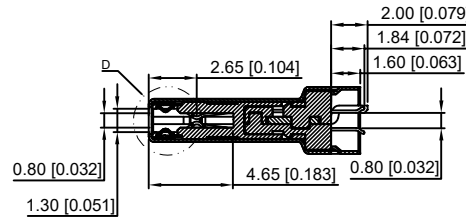

SECT A-A

A12	A11	A10	A9	A8	A7	A6	A5	A4	A3	A2	A1
GND	RX2+	RX2-	Vbus	SBU1	D-	D+	CC	Vbus	TX1-	TX1+	GND
GND	TX2+	TX2-	Vbus	Vconn			SBU2	Vbus	RX1-	RX1+	GND
B1	B2	B3	B4	B5	B6	B7	B8	B9	B10	B11	B12

ITEM	DESCRIPTION	MATERIAL	REMARKS
6	Shrapnel	SUS T=0.10mm	
5	Shell	SUS T=0.15mm	Over-plating: Ni
4	Terminal	C7025 T=0.15mm	Over-plating: Au Ni/Sn
3	Latch	SUS T=0.4mm	
2	Housing	LCP	UL94-0
1	Housing Stopper	LCP	UL94-0

					ANGLAR	±5°	DSND	DATE	SCALE: N/A	MODEL TYPE:		
ΔX					L ≤ 4	±0.2	DWN	DATE	VIEW:	3.1 TYPE C		
ΔX					4 < L ≤ 16	±0.3	CHKD	DATE	UNIT: mm/in	PART NO.:		
ΔX					16 < L ≤ 63	±0.4	APPD	DATE	SIZE: A4	DWG NO.:		
MARK	DESCRIPTION	DATE	REVISED	APPROVED	L > 63	±0.5				U261-24XXN-4B0417		
REVISIONS					UNSPECIFIED TOLERANCES		XKB INDUSTRIAL PRECISION CO.,LIMITED			WEIGHT	SHEET	REVISION
www.xk-dg.cn www.helloxkb.com www.helloxkb.cn										1.0g	1/1	A0

X-ON Electronics

Largest Supplier of Electrical and Electronic Components

Click to view similar products for [USB Connectors](#) category:

Click to view products by [XKB](#) manufacturer:

Other Similar products are found below :

[950](#) [A-USB B-TOP-C](#) [MUSBA511N5](#) [MUSBC111M5](#) [MUSBD11135](#) [17-200721](#) [217450-1](#) [KMBVX-TH-5S-B30](#) [896-30-004-00-000000](#)
[KUSBX-AS2N-W](#) [KUSBX-SMT2AP1S-W30](#) [935](#) [957](#) [30-498-6](#) [SK-60A-2](#) [1734082-1](#) [30-1574](#) [30-470](#) [30-489](#) [30-541](#) [30-572-3](#) [A-USB](#)
[A-2P-C](#) [MIKROE-1451](#) [USBFTV2PEM2G](#) [USBFTVSCCG](#) [4689-1](#) [1-1734084-2](#) [MUSBC11135](#) [USBF21ZNSCC](#) [USBBFTV6ZC](#)
[MUSBB151341](#) [10135326-001LF](#) [M9177/3-1](#) [TJ-105](#) [USB-A-S-F-B-VT](#) [4198](#) [690-024-633-031](#) [UB-20PMFP-LC7001](#) [USBFTVC6MRG](#)
[UA-20BMFA-SL8001](#) [17-200011](#) [USBFTVC7ZC](#) [UB-20AFMM-LL7A01](#) [USBFTVC2MN](#) [CAP-WCCMLPB1](#) [1310-1031-01](#) [2041386-1](#)
[2274475-3](#) [UB-20BMFA-SL8001](#) [UB-20PMFP-SC8003](#)