

XKB CONNECTIVITY
XKB

NOTE:

1. MATERIAL SPECIFICATION:
 1. HOUSING: LCP UL94 V-0.
 2. TERMINAL: COPPER ALLOY
 3. MID PLATE: STAINLESS STEEL
 4. FRONT SHELL: STAINLESS STEEL
 5. EMI PLATE: STAINLESS STEEL
2. PLATING SPECIFICATION:
 - 2-1. TERMINAL:
 - Ni 50μ" MIN. UNDER PLATED OVER ALL.
 - Au PLATED ON THE FUNCTIONAL AREA OF CONTACT.
 - (GOLD PLATING THICKNESS FOLLOW THE P/N)
 - PLATING SPECIFICATIONS OF THE SOLDER AREA FOLLOW THE P/N
 - 2-2. FRONT SHELL:
 - PLATING SPECIFICATIONS FOLLOW THE P/N
 - 2-3. MID PLATE&EMI PLATE:
 - CLEAR ONLY
3. MECHANICAL PERFORMANCE:
 - 3-1. INSERTION FORCE: 0.5~2.0kgf.
 - 3-2. REMOVAL FORCE: 0.8kgf~2.0kgf.
 - 3-3. DURABILITY: 10000 CYCLES.
4. ELECTRICAL PERFORMANCE:
 - 4-1. VOLTAGE RATING: 5 V DC/AC (RMS. max)
 - CURRENT RATING: 5 AMPS. FOR TOTAL VBUS/GND PINS;
 - 1.25AMPS FOR CC PIN, 0.25 AMPS. FOR ALL OTHER CONTACT.
 - 4-2. LLCR:
 - VBUS & GND PINS AND OTHER PINS: 40mΩ/PIN MAX.
 - SHIELD: 50mΩ/MAX
 - LLCR MAX. CHANGE OF ALL PINS: 10mΩ.
 - 4-3. INSULATION RESISTANCE: 100MΩ MIN
 - 4-4. DIELECTRIC WITHSTAND VOLTAGE, AC 100V FOR 1 MINUTE.
5. ENVIRONMENTAL PERFORMANCE:
 - OPERATING TEMPERATURE: -25°C~+85°C.
6. IR REFLOW:
 - THE PEAK TEMPERATURE ON THE BOARD SHALL BE MAINTAINED FOR 10 SECONDS AT 260°C.

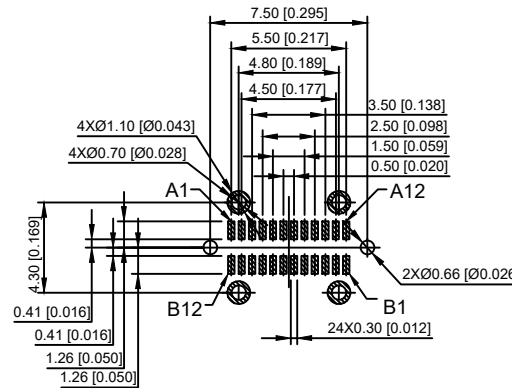
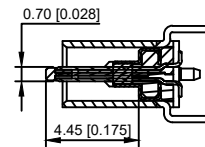
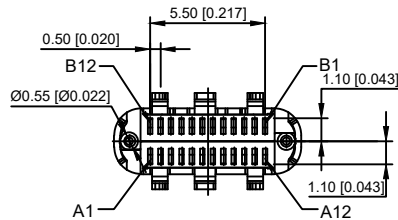
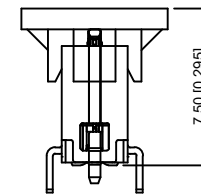
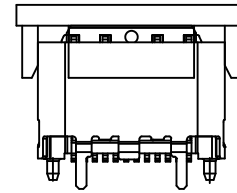
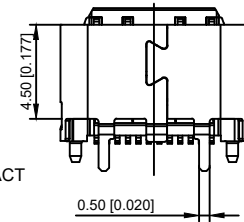
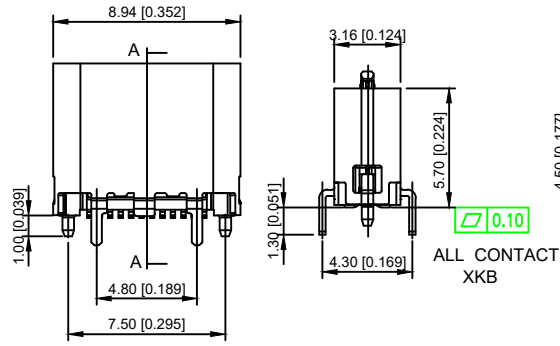

RECOMMENDED PCB LAYOUT(TOP VIEW)
DEFAULT TOLERANCE:±0.05

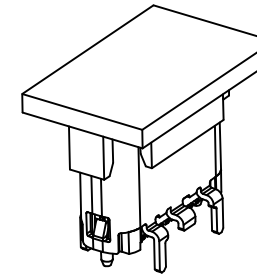

WITH PICK UP COVER
XKB

XKB CONNECTIVITY
U263-24XN-4BQC03

1:Au 1U"	1:PBT
2:Au 3U"	2:PA6T
3:Au 15U"	3:PA9T
4:Au 30U"	4:LCP

					ANGLAR	±5°	DSND	DATE	SCALE: N/A	MODEL TYPE:	3.1 TYPE C	
					L ≤ 4	±0.2	DWN	DATE	VIEW:	PART NO.:		
					4 < L ≤ 16	±0.3	CHKD	DATE	UNIT: mm/in	DWG NO.:		
					16 < L ≤ 63	±0.4	APPD	DATE	SIZE: A4	U263-24XN-4BQC03		
					L > 63	±0.5	KXB INDUSTRIAL PRECISION CO., LIMITED					
					UNSPECIFIED TOLERANCES							
MARK	DESCRIPTION	DATE	REVISED	APPROVED				WEIGHT	SHEET	REVISION		
REVISIONS								1.0g	1/1	A0		
www.xk-dg.cn www.helloxkb.com www.helloxkb.cn												

X-ON Electronics

Largest Supplier of Electrical and Electronic Components

Click to view similar products for [USB Connectors](#) category:

Click to view products by [XKB](#) manufacturer:

Other Similar products are found below :

[950](#) [A-USB B-TOP-C](#) [MUSBA511N5](#) [MUSBC111M5](#) [MUSBD11135](#) [17-200721](#) [217450-1](#) [KMBVX-TH-5S-B30](#) [896-30-004-00-000000](#)
[KUSBX-AS2N-W](#) [KUSBX-SMT2AP1S-W30](#) [935](#) [957](#) [30-498-6](#) [SK-60A-2](#) [1734082-1](#) [30-1574](#) [30-470](#) [30-489](#) [30-541](#) [30-572-3](#) [A-USB](#)
[A-2P-C](#) [MIKROE-1451](#) [USBFTV2PEM2G](#) [USBFTVSCCG](#) [4689-1](#) [1-1734084-2](#) [MUSBC11135](#) [USBF21ZNSCC](#) [USBBFTV6ZC](#)
[MUSBB151341](#) [10135326-001LF](#) [M9177/3-1](#) [TJ-105](#) [USB-A-S-F-B-VT](#) [4198](#) [690-024-633-031](#) [UB-20PMFP-LC7001](#) [USBFTVC6MRG](#)
[UA-20BMFA-SL8001](#) [17-200011](#) [USBFTVC7ZC](#) [UB-20AFMM-LL7A01](#) [USBFTVC2MN](#) [CAP-WCCMLPB1](#) [1310-1031-01](#) [2041386-1](#)
[2274475-3](#) [UB-20BMFA-SL8001](#) [UB-20PMFP-SC8003](#)