

AUTODESK

XKB

NOTES:

SPECIFICATION:

1. CURRENT RATING: 3.0A MAX
2. VOLTAGE: 100 VAC
3. TEMPERATURE RANGE: -30 °C ~ 85 °C
4. CONTACT RESISTANCE: 40 MILLIONHM MAX
5. INSULATION RESISTANCE: 100 MEGOHMS MIN.
6. LNSERTION FORCE : 5N~20N
7. UNMATING FORCE: 8N~20N
8. DURABILITY: 10,000 CYCLES

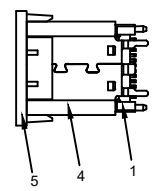
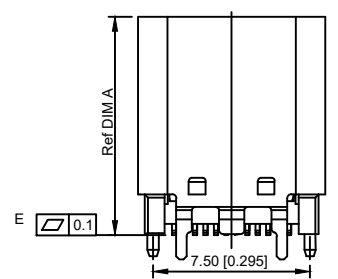
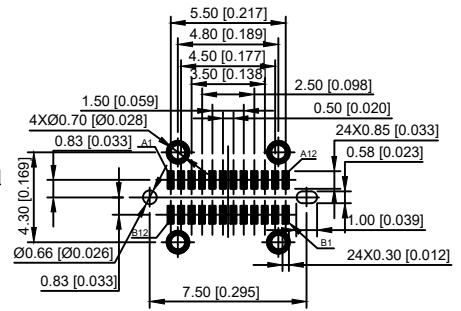
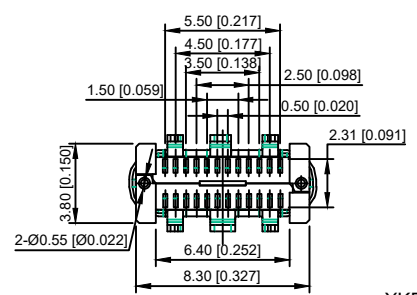
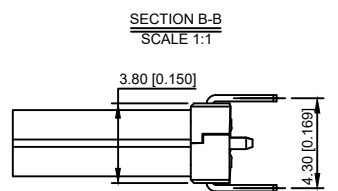
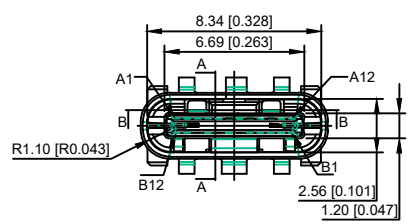
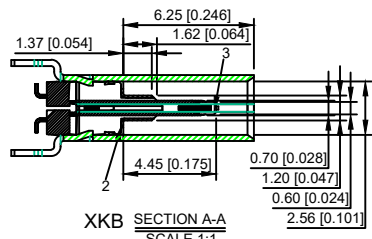
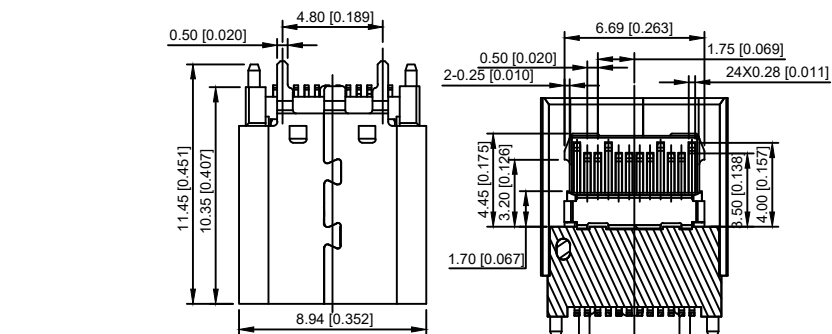

A1	GND	B12	GND
A2	SSTXP1	B11	SSRXP1
A3	SSTXN1	B10	SSRXN1
A4	VBUS	B9	VBUS
A5	CC1	B8	SBU2
A6	DP1	B7	DN2
A7	DN1	B6	DP2
A8	SBU1	B5	CC2
A9	VBUS	B4	VBUS
A10	SSRXN2	B3	SSTXN2
A11	SSRXP2	B2	SSTXP2
A12	GND	B1	GND
PIN	SIGNAL NAME	PIN	SIGNAL NAME

NO	DIM A	DIM B	DIM C
1	10.5	11.50	1.15/2.25
2	10.0	11.00	1.15/2.25
3	9.3	10.30	1.15/2.25

U263-24XN-4BQC11-X

- 1: Au 1U"
- 2: Au 3U"
- 3: Au 15U"
- 4: Au 30U"
- W: WHITE
- B: BLACK
- 1: PBT
- 2: PA6T
- 3: PA9T
- 4: LCP

XKB

NO.	DESCRIPTION	MATERIAL	REMARKS	QTY
5	COVER	HIGH TEMPERATURE PLASTIC	BLACK	1PCS
4	SHELL	STAINLESS STEEL T=0.30	NI PLATED	1PCS
3	IRON HOUSING	HIGH TEMPERATURE PLASTIC	BLACK/NATURE	1PCS
2	SPRING	STAINLESS STEEL T=0.10	NI PLATED	1PCS
1	TERMINAL HOUSING	HIGH TEMPERATURE PLASTIC	BLACK/NATURE/GREEN	2PCS

MARK	DESCRIPTION	DATE	REVISED	APPROVED	UNSPECIFIED TOLERANCES	DSND	DATE	SCALE: N/A	MODEL TYPE: 3.1 TYPE C
ΔX					ANGULAR ±5°	DWN	DATE	VIEW:	PART NO.:
ΔX					L ≤ 4 ±0.2	CHKD	DATE	UNIT: mm/in	DWG NO.:
ΔX					4 < L ≤ 16 ±0.3	APPD	DATE	SIZE: A4	U263-24XN-4BQC11-X
					16 < L ≤ 63 ±0.4				WEIGHT SHEET REVISION
					L > 63 ±0.5				1.0g 1/1 A0

AUTODESK

AUTODESK

AUTODESK

XKB INDUSTRIAL PRECISION CO., LIMITED

www.xk-dg.cn www.helloxkb.com www.helloxkb.cn

X-ON Electronics

Largest Supplier of Electrical and Electronic Components

Click to view similar products for [USB Connectors](#) category:

Click to view products by [XKB](#) manufacturer:

Other Similar products are found below :

[950](#) [A-USB B-TOP-C](#) [MUSBA511N5](#) [MUSBC111M5](#) [MUSBD11135](#) [17-200721](#) [217450-1](#) [KMBVX-TH-5S-B30](#) [896-30-004-00-000000](#)
[KUSBX-AS2N-W](#) [KUSBX-SMT2AP1S-W30](#) [935](#) [957](#) [30-498-6](#) [SK-60A-2](#) [1734082-1](#) [30-1574](#) [30-470](#) [30-489](#) [30-541](#) [30-572-3](#) [A-USB](#)
[A-2P-C](#) [MIKROE-1451](#) [USBFTV2PEM2G](#) [USBFTVSCCG](#) [4689-1](#) [1-1734084-2](#) [MUSBC11135](#) [USBF21ZNSCC](#) [USBBFTV6ZC](#)
[MUSBB151341](#) [10135326-001LF](#) [M9177/3-1](#) [TJ-105](#) [USB-A-S-F-B-VT](#) [4198](#) [690-024-633-031](#) [UB-20PMFP-LC7001](#) [USBFTVC6MRG](#)
[UA-20BMFA-SL8001](#) [17-200011](#) [USBFTVC7ZC](#) [UB-20AFMM-LL7A01](#) [USBFTVC2MN](#) [CAP-WCCMLPB1](#) [1310-1031-01](#) [2041386-1](#)
[2274475-3](#) [UB-20BMFA-SL8001](#) [UB-20PMFP-SC8003](#)