

LEFT SIDE VIEW

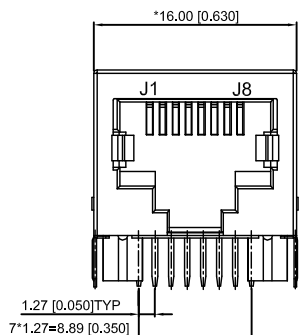

FRONT VIEW

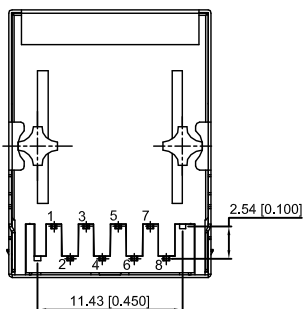

BOTTOM VIEW

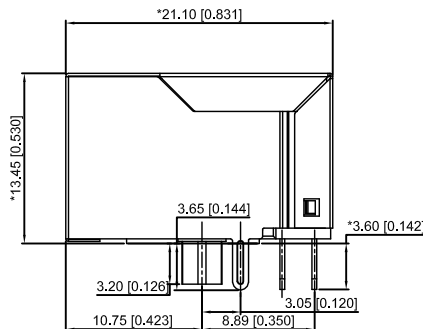

RIGHT SIDE VIEW

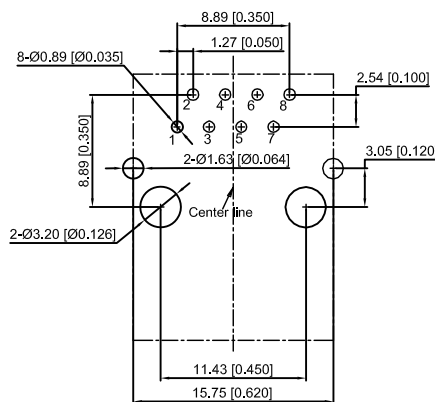

RECOMMENDED PCB LAYOUT  
VIEWED FROM COMPONENT SIDE  
XKB Connectivity

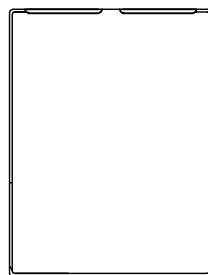

TOP VIEW

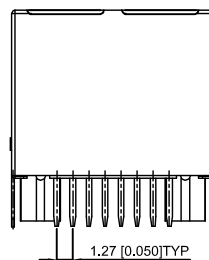

BACK VIEW

XKB Connectivity

Electrical 电气:

- Turn ratio 匝数比: 1~2: J1~J2=1CT:1CT(±2%), 3~6: J3~J6=1CT:1CT(±2%)
- OCL: 350uH Min. at 100KHz 100mV 8mA DC.
- Insertion Loss 插入损耗: -1.0 dB Max 1~100MHz.
- Return loss 回波损耗: -20dB Min 1~10MHz, -16dB Min 10~30MHz, -12dB Min 30~60MHz, -10dB Min 60~80MHz.
- Cross talk: -40dB Min 1~30MHz; -35dB Min 30~60MHz; -30dB Min 60~100MHz;
- CMR: -30dB Min 1~100MHz;
- Hi-Pot: 1500V AC & 2250V DC 6S 1mA PRI TO SEC.

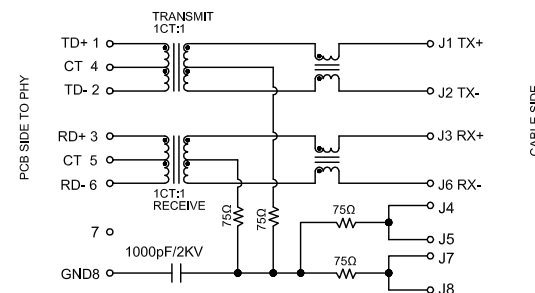

XKB Connectivity

MATERIAL 材料:

- HOUSING 外壳: PBT, UL94V-0, BLACK.
- TERMINALS BRACKET 端子支架: PBT, UL94V-0, BLACK.
- SHIELD 保护物: C2680, T=0.20MM, NICKEL PLATING ON ALL AREA.
- TERMINAL 端子: PHOSPHOR BRONZE C5210, T=0.35MM, GOLD PLATING ON CONTACT AREA.

MECHANICAL 机械:

- DURABILITY 耐用性: 750 CYCLES MIN.
- MATING FORCE 配合力: 23N MAX.
- OPERATING TEMPERATURE 工作温度: -40°C~+85°C.
- STORAGE TEMPERATURE 储存温度: -40°C~+85°C.
- ALL CRITICAL DIMENSIONS WITH "★"

DSND		DATE		SCALE: N/A	MODEL TYPE: RJ JACK
DWN		DATE		VIEW:	PART NO.:
CHKD		DATE		UNIT: mm/in	DWG NO.:
APPD		DATE		SIZE: A4	X01AB002GWAD
				XKB INDUSTRIAL PRECISION CO., LIMITED	WEIGHT 1.0g
					SHEET 1/1
					REVISION A0

					ANGLAR	±5°
ΔX					L ≤ 4	±0.2
ΔX					4 < L ≤ 16	±0.3
ΔX					16 < L ≤ 63	±0.4
MARK	DESCRIPTION	DATE	REVISED	APPROVED	L > 63	±0.5
REVISIONS						UNSPECIFIED TOLERANCES
www.xk-dg.cn www.helloxkb.com www.helloxkb.cn						

## X-ON Electronics

Largest Supplier of Electrical and Electronic Components

*Click to view similar products for [Modular Connectors](#) / [Ethernet Connectors](#) category:*

*Click to view products by [XKB](#) manufacturer:*

Other Similar products are found below :

[8949-H88/06BLKA/SN](#) [74441-0010/BKN](#) [PHP-6P6C-5](#) [GAX-3-66](#) [GDCX-PN-66](#) [GLX-A-44](#) [GLX-N-1010M-BLK](#) [GLX-S-88M-BLK](#)  
[GMX-SMT4-N-88](#) [GSGX-N-2-88](#) [GSGX-N-4-88](#) [GSX-NS2-88-3.05](#) [GSX-NS-88-3.68](#) [PT-108A-8C-UL](#) [PTS-J531-8CS-50UL](#) [A-2014-0-4](#)  
[GWLX-S9-88-YG](#) [DC-1021-8-WH-6](#) [1300530003](#) [1324640-4](#) [132764-001](#) [1413235](#) [MPS88RX-5000](#) [E5288-S000K3-L](#) [155302-001](#)  
[AX101050](#) [AX101063](#) [AX101065](#) [AX101072](#) [AX101307](#) [AX101315](#) [AX101318](#) [AX102271](#) [AX102277](#) [AX102651](#) [AX102660](#) [AX104024](#)  
[203475](#) [PC4D0018P](#) [KIT38082NI](#) [8949-B88/6](#) [2-6609208-5](#) [30-8956](#) [30-8964-100](#) [SM85](#) [SM99S01VBNN04G7](#) [17-103540](#) [191587](#) [PDI-68-RV](#) [PHP-8P8C-S-5](#)