

LEFT SIDE VIEW

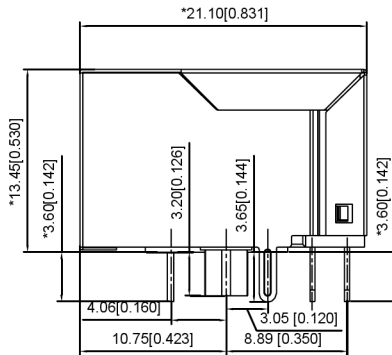

RIGHT SIDE VIEW

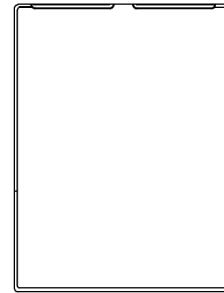

TOP VIEW

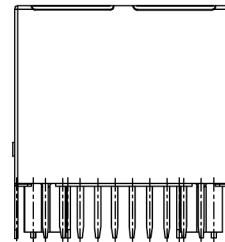

BACK VIEW

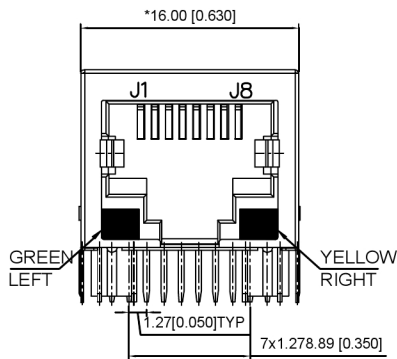

FRONT VIEW

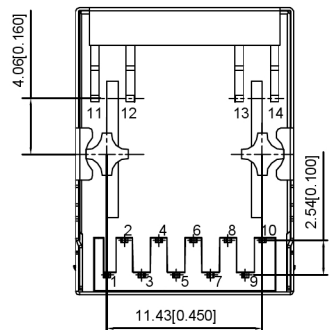

BOTTOM VIEW

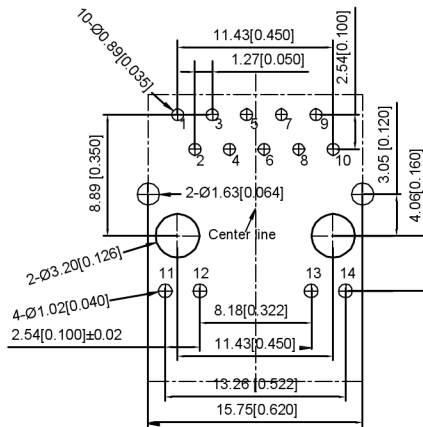

RECOMMENDED PCB LAYOUT VIEWED FROM COMPONENT SIDE

Electrical 电气:

- Turn ratio 匝数比: 1~2: J1~J2=1CT:1CT(±2%)
3~4: J3~J6=1CT:1CT(±2%)
7~8: J4~J5=1CT:1CT(±2%)
9~10: J7~J8=1CT:1CT(±2%)
- OCL: 350uH Min. at 100KHz 100mV 8mA DC.
- Insertion Loss 插入损耗: -1.0 dB Max 1~100MHz.
- Return loss 回程损耗: -18dB Min 1~30MHz
-14dB Min 30~60MHz
-12dB Min 60~80MHz
-10dB Min 80~100MHz
- Cross talk 声道串扰: -40dB Min 1~30MHz;
-35dB Min 30~60MHz;
-30dB Min 60~100MHz;
- CMR 共模抑制: -30dB Min 1~100MHz;
- Hi-Pot 耐压测试: 1500V AC & 2250V DC 6S
1mA PRI TO SEC

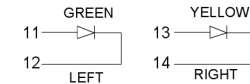
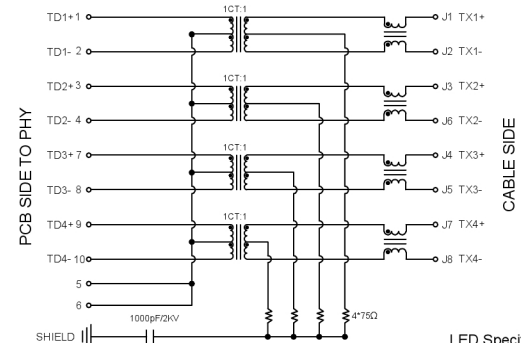

Standard LED Color	LED Wavelength	Forward(A)	Forward(V)
Green	568nm	20mA	1.85-2.45
Yellow	585nm	20mA	1.7-2.2V

KXB Connectly

MATERIAL 材料:

HOUSING 外壳: PBT,UL94V-0,BLACK, HF
 TERMINALS BRACKET 端子支架: PBT,UL94V-0,BLACK, HF
 SHIELD 保护物: C2680,T=0.20MM,NICKEL PLATING ON ALL AREA.
 TERMINAL 端子: PHOSPHOR BRONZE C5210,T=0.35MM,
 GOLD PLATING ON CONTACT AREA.

MECHANICAL 机械:

DURABILITY 耐用性: 750 CYCLES MIN.
 MATING FORCE 配合力: 23N MAX.
 OPERATING TEMPERATURE 工作温度: -40°C~+85°C.
 STORAGE TEMPERATURE 储存温度: -40°C~+85°C.
 ALL CRITICAL DIMENSIONS WITH "MM"

广东星坤科技股份有限公司

Δ X	日期
Δ X	日期
Δ X	日期
MARK	DESCRIPTION

文件工程章

REVISIONS	DATE	REVISED	APPROVED	DESCRIPTION

DSND	SCALE: N/A	MODEL TYPE:	RJ JACK
DWN	VIEW:	PART NO.:	
CHKD	UNIT: mm/in	DWG NO.:	X01AQ070AB2AD
APPD	SIZE: A4	WEIGHT	SHEET
			REVISIO
			A0



X-ON Electronics

Largest Supplier of Electrical and Electronic Components

Click to view similar products for [Modular Connectors](#) / [Ethernet Connectors](#) category:

Click to view products by [XKB](#) manufacturer:

Other Similar products are found below :

[8949-H88/06BLKA/SN](#) [74441-0010/BKN](#) [PHP-6P6C-5](#) [GAX-3-66](#) [GDCX-PN-66](#) [GLX-A-44](#) [GLX-N-1010M-BLK](#) [GLX-S-88M-BLK](#)
[GMX-SMT4-N-88](#) [GSGX-N-2-88](#) [GSGX-N-4-88](#) [GSX-NS2-88-3.05](#) [GSX-NS-88-3.68](#) [PT-108A-8C-UL](#) [PTS-J531-8CS-50UL](#) [A-2014-0-4](#)
[GWLX-S9-88-YG](#) [DC-1021-8-WH-6](#) [1300530003](#) [1324640-4](#) [132764-001](#) [1413235](#) [MPS88RX-5000](#) [E5288-S000K3-L](#) [155302-001](#)
[AX101050](#) [AX101063](#) [AX101065](#) [AX101072](#) [AX101307](#) [AX101315](#) [AX101318](#) [AX102271](#) [AX102277](#) [AX102651](#) [AX102660](#) [AX104024](#)
[203475](#) [PC4D0018P](#) [KIT38082NI](#) [8949-B88/6](#) [2-6609208-5](#) [30-8956](#) [30-8964-100](#) [SM85](#) [SM99S01VBNN04G7](#) [17-103540](#) [191587](#) [PDI-68-RV](#) [PHP-8P8C-S-5](#)