

LEFT SIDE VIEW

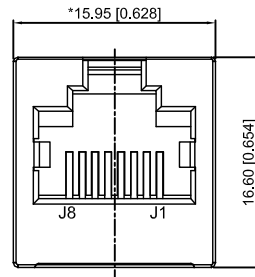

FRONT VIEW

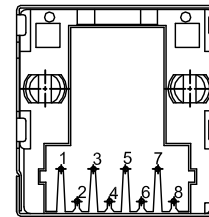

BACK VIEW

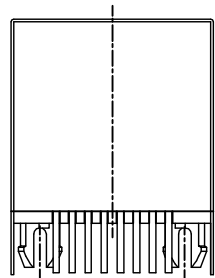
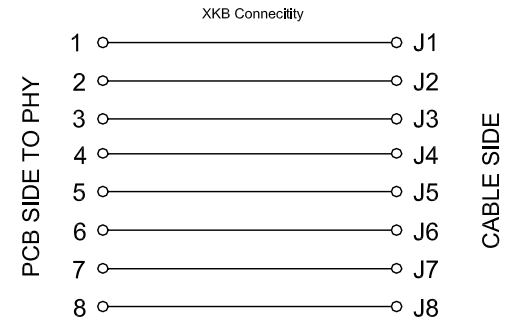

BOTTOM VIEW

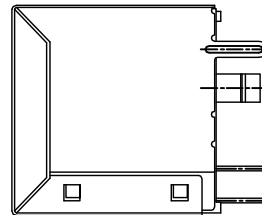

RIGHT SIDE VIEW

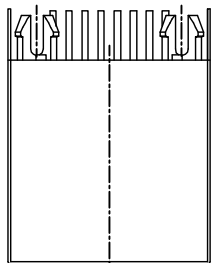

TOP VIEW

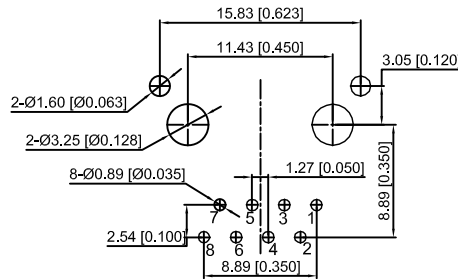

RECOMMENDED PCB LAYOUT
VIEWED FROM COMPONENT SIDE

XKB Connectivity

XKB Connectivity

MATERIAL 材料:

HOUSING 外壳: PBT,UL94V-0,BLACK.

TERMINAL 端子: PHOSPHOR BRONZE ,Ø=0.46MM,
GOLD PLATING ON CONTACT AREA.

SHIELD 保护物:C2680,T=0.20MM,20 MIN NICKEL PLATING
ON ALL AREA.

MECHANICAL 机械:

DURABILITY 耐用性: 750 CYCLES MIN.12.5MM/MINUTE

INSERTION FORCE 插入力: 2.2KG.F MAX

RETENTION STRENGTH 固位力:7.7KG.F BETWEEN JACK AND PLUG

OPERATING TEMPERATURE 工作温度: -40°C~+85°C.

STORAGE TEMPERATURE 储存温度: -40°C~+85°C.

ALL CRITICAL DIMENSIONS WITH "*"

ELECTRICAL 电动:

VOLTAGE 电压:125 VOL TS AC

CURRENT RATING 额定电流:1.5AMP

DIELECTRIC STRENGTH 介电强度:1000 VAC RMS 50HZ OR 60HZ,1MIN

INSULATION RESISTANCE 绝缘电阻:500 MEGA OHMS MIN.INITIAL
AFTER 500V DC FOR 1 MINUTE

CONTACT RESISTANCE 接触电阻:SINGLE TERMINAL 30 MILLIOHMS MAX
INITIAL 50 MILLIOHMS MAX.AFTER
DURABILITY TEST

					DSND		DATE		SCALE: N/A	MODEL TYPE: RJ JACK		
					ANGLAR		DATE		VIEW:	PART NO.:		
					L ≤ 4		DATE		UNIT: mm/in	DWG NO.:		
					4 < L ≤ 16		DATE		SIZE: A4	X05ADGWA3DY1027		
					16 < L ≤ 63		DATE			WEIGHT	SHEET	REVISION
					L > 63		DATE			1.0g	1/1	A0
					UNSPECIFIED TOLERANCES	XKB INDUSTRIAL PRECISION CO.,LIMITED						
ΔX												
ΔX												
ΔX												
MARK	DESCRIPTION	DATE	REVISED	APPROVED								
REVISIONS												
www.xk-dg.cn www.helloxkb.com www.helloxkb.cn												

X-ON Electronics

Largest Supplier of Electrical and Electronic Components

Click to view similar products for [Modular Connectors](#) / [Ethernet Connectors](#) category:

Click to view products by [XKB](#) manufacturer:

Other Similar products are found below :

[8949-H88/06BLKA/SN](#) [74441-0010/BKN](#) [PHP-6P6C-5](#) [GAX-3-66](#) [GAX-8-62](#) [GDCX-PN-66](#) [GLX-A-44](#) [GLX-N-1010M-BLK](#) [GMX-SMT4-N-88](#) [GSGX-N-2-88](#) [GSGX-N-4-88](#) [GSX-NS2-88-3.05](#) [GSX-NS-88-3.68](#) [PT-108A-8C-UL](#) [PTS-J531-8CS-50UL](#) [A-2014-0-4](#)
[GWLX-S9-88-YG](#) [DC-1021-8-WH-6](#) [1300530003](#) [1324640-4](#) [RJ11FTVC2G](#) [RJ11FTVC2N](#) [RJFTVX2SA1G](#) [132764-001](#) [1413235](#)
[MPS88RX-5000](#) [E5288-S000K3-L](#) [155302-001](#) [AX101050](#) [AX101063](#) [AX101065](#) [AX101072](#) [AX101307](#) [AX101315](#) [AX101318](#)
[AX102271](#) [AX102288](#) [AX102651](#) [AX102660](#) [J0012D21NL](#) [J0026D01ENL](#) [PC4D0018P](#) [8949-B88/6](#) [2-6609208-5](#) [937-SP-3088-2PC-A192](#)
[303066VFL](#) [303068V](#) [303088LFLSA](#) [303088SBL](#) [30-8603](#)