

FRONT VIEW

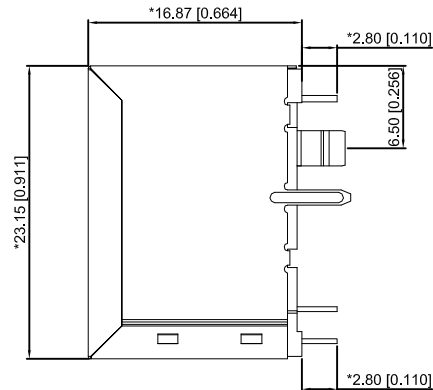

RIGHT SIDE VIEW

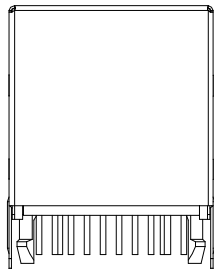

BOTTOM VIEW

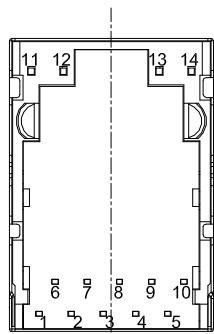

BACK VIEW

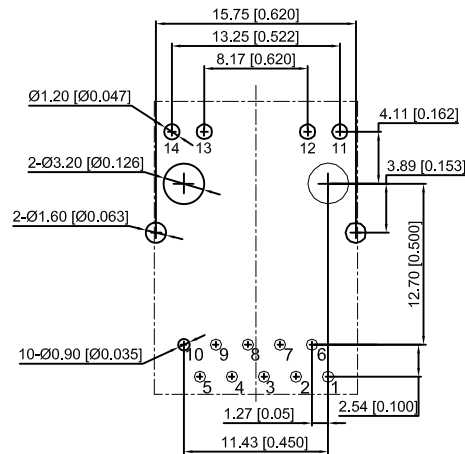

RECOMMENDED PCB LAYOUT VIEWED FROM COMPONENT SIDE

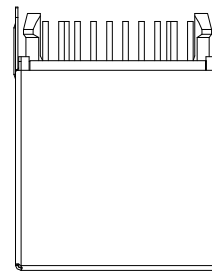

TOP VIEW

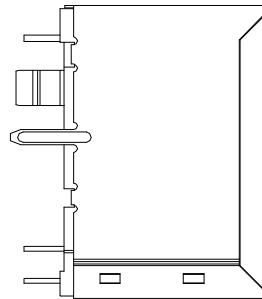

LEFT SIDE VIEW

Electrical 电气:

- Turn ratio 匝数比: 5~9: J1~J2=1CT:1CT(±2%), 4~8: J3~J6=1CT:1CT(±2%), 3~7: J4~J5=1CT:1CT(±2%), 2~6: J7~J8=1CT:1CT(±2%)
- OCL: 350uH Min. at 100KHz 100mV 8mA DC.
- Insertion Loss 插入损耗: -1.0 dB Max 1~100MHz.
- Return loss 回波损耗: -18dB Min 1~30MHz, -14dB Min 30~60MHz, -12dB Min 60~80MHz, -10dB Min 80~100MHz.
- Cross talk: -40dB Min 1~30MHz; -35dB Min 30~60MHz; -30dB Min 60~100MHz;
- CMR: -30dB Min 1~100MHz;
- Hi-Pot: 2250V DC 6S 1mA PRI TO SEC.

LED Specification

Standard LED Color	LED Wavelength	Forward(A)	Forward(V)
Green	568nm	20mA	1.85-2.45V
Yellow	589nm	20mA	1.7-2.2V

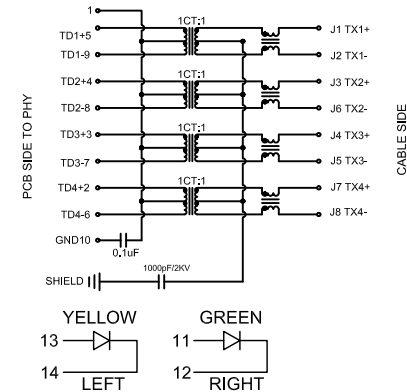

XKB Connectivity

MATERIAL 材料:

- HOUSING : PBT,UL94V-0,BLACK.
- TERMINALS BRACKET 端子支架: PBT,UL94V-0,BLACK.
- SHIELD 保护物: C2680,T=0.20MM,NICKEL PLATING ON ALL AREA.
- TERMINAL 端子: PHOSPHOR BRONZE C5191,T=0.35MM, GOLD PLATING ON CONTACT AREA.

MECHANICAL 机械:

- DURABILITY 耐用性: 750 CYCLES MIN.
- MATING FORCE 配合力: 23N MAX.
- OPERATING TEMPERATURE 工作温度: -40°C~+85°C.
- STORAGE TEMPERATURE 储存温度: -40°C~+85°C.
- ALL CRITICAL DIMENSIONS WITH "*"

DSND		DATE		SCALE: N/A	MODEL TYPE: RJ JACK
DWN		DATE		VIEW:	PART NO.:
CHKD		DATE		UNIT: mm/in	DWG NO.:
APPD		DATE		SIZE: A4	X05AQ030AC10D057
				XKB INDUSTRIAL PRECISION CO.,LIMITED	WEIGHT 1.0g
					SHEET 1/1
					REVISION A0

ΔX					ANGLAR	±5°
ΔX					L ≤ 4	±0.2
ΔX					4 < L ≤ 16	±0.3
MARK	DESCRIPTION	DATE	REVISED	APPROVED	16 < L ≤ 63	±0.4
	REVISIONS				L > 63	±0.5
						UNSPECIFIED TOLERANCES
www.xk-dg.cn www.helloxkb.com www.helloxkb.cn						

X-ON Electronics

Largest Supplier of Electrical and Electronic Components

Click to view similar products for [Modular Connectors](#) / [Ethernet Connectors](#) category:

Click to view products by [XKB](#) manufacturer:

Other Similar products are found below :

[8949-H88/06BLKA/SN](#) [74441-0010/BKN](#) [PHP-6P6C-5](#) [GAX-3-66](#) [GAX-8-62](#) [GDCX-PN-66](#) [GLX-A-44](#) [GLX-N-1010M-BLK](#) [GMX-SMT4-N-88](#) [GSGX-N-2-88](#) [GSGX-N-4-88](#) [GSX-NS2-88-3.05](#) [GSX-NS-88-3.68](#) [PT-108A-8C-UL](#) [PTS-J531-8CS-50UL](#) [A-2014-0-4](#) [GWLX-S9-88-YG](#) [DC-1021-8-WH-6](#) [1300530003](#) [1324640-4](#) [RJ11FTVC2G](#) [RJ11FTVC2N](#) [RJFTVX2SA1G](#) [132764-001](#) [1413235](#) [MPS88RX-5000](#) [E5288-S000K3-L](#) [155302-001](#) [AX101050](#) [AX101063](#) [AX101065](#) [AX101072](#) [AX101307](#) [AX101314](#) [AX101315](#) [AX101318](#) [AX102271](#) [AX102288](#) [AX102651](#) [AX102660](#) [J0012D21NL](#) [J0026D01ENL](#) [PC4D0018P](#) [8949-B88/6](#) [2-6609208-5](#) [937-SP-3088-2PC-A192](#) [303066VFL](#) [303068V](#) [303088LFLSA](#) [303088SBL](#)