

WITH CAP

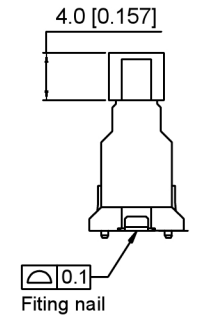

WITH CAP

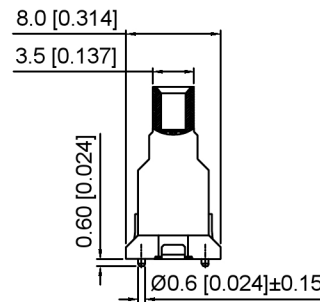
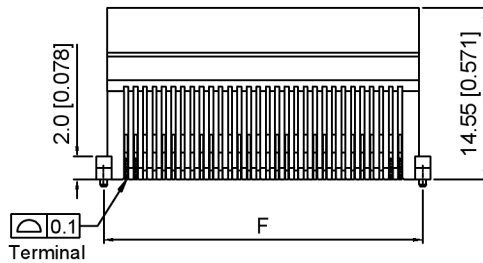
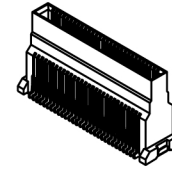
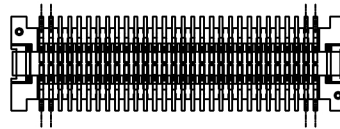
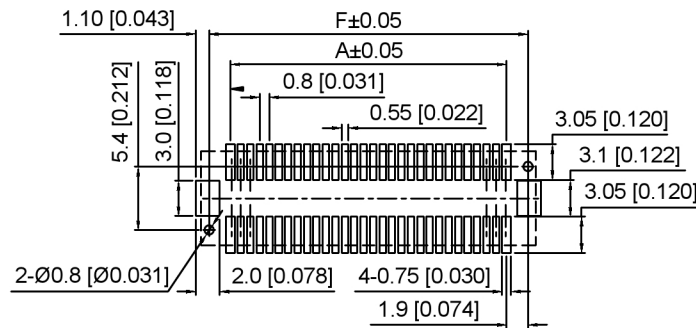

Recommended PCB Layout

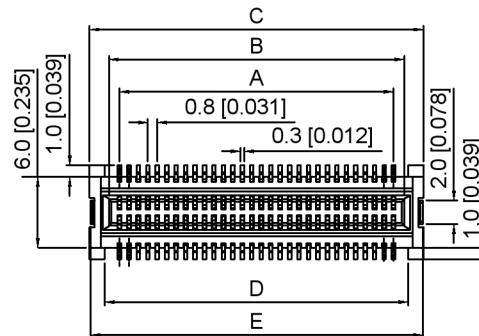

Specifications:

规格:

Voltage rating: 50V AC/DC

额定电压: 50V AC/DC

Current rating: 0.5A AC/DC

额定电流: 0.5A AC/DC

Withstanding voltage: 250V AC/minute

耐受电压: 250V AC/分钟

Temperature range: -40°C-+105°C

温度范围: -40°C-+105°C

Insulation resistance: 500MΩ

绝缘电阻: 500MΩ

Contact resistance: 100mΩ

接触电阻: 100mΩ

X0815 W V S-XX F S-9T V01

① ② ③ ④ ⑤ ⑥ ⑦ ⑧ ⑨

1. Series No
2. Category: W-Wafer
3. Welding Board Angle: V-Straight 180°
4. Welding Way: S-SMT
5. Row No. Pin No: XX-30-60Pin
6. Category: F-14.55mm Height
7. Special No: S-With positioning column
8. Material: 9T-PA9T UL94V-0
CAP Material: PA6T UL94V-0
9. Plating: Gold Plated 3u" MIN

Poles	Dimensions(mm)					
	A	B	C	D	E	F
30	11.20	13.00	16.30	13.70	16.10	15.00
40	15.20	17.00	20.30	17.70	20.10	19.00
50	19.20	21.00	24.30	21.70	24.10	23.00
60	23.20	25.00	28.30	25.70	28.10	27.00

X0815WVS-XXFS-9TV01	PA9T	Phosphor Bronze	X0815FVS-A	19.5mm±0.5
			X0815FVS-B	15.75mm±0.5
PART NO	Material	Material(Pin)	Suitable XKB Wafer	Mating Height

DSND	SCALE: N/A	MODEL TYPE: 0.8mm BTB Connector
DWN	VIEW:	PART NO.: X0815WVS-XXFS-9TV01
CHKD	UNIT: mm/in	DWG NO.:
APPD	SIZE: A4	X-X0815WVS-XXFS-9TV01



XKB INDUSTRIAL PRECISION CO., LIMITED

WEIGHT	SHEET	REVISION
	1/1	A0

广东星坤科技股份有限公司

MARK	DESCRIPTION	DATE	REVISED	APPROVED
Δx	日期			
Δx				
Δx				

文件工程章

REVISIONS	UNSPECIFIED TOLERANCES
	ANGULAR ±5°
	L ≤ 4 ±0.2
	4 < L ≤ 16 ±0.3
	16 < L ≤ 63 ±0.4
	L > 63 ±0.5

X-ON Electronics

Largest Supplier of Electrical and Electronic Components

Click to view similar products for [Board to Board & Mezzanine Connectors](#) category:

Click to view products by [XKB](#) manufacturer:

Other Similar products are found below :

[589158040000018](#) [MDF7C-18P-2.54DSA\(55\)](#) [FCN-268F036-G/BD](#) [FCN-268M012-G/0D](#) [FCN-268M024-G/1D](#) [MIS-048-01-F-D-DP-K](#)
[832-10-034-10-001000](#) [FX4C-80S-1.27DSA](#) [93696-330](#) [224393](#) [FCN-235D050-G/C](#) [210-93-314-41-105000](#) [MDF7-40DP-2.54DSA\(55\)](#)
[55323-1519](#) [069159702701000](#) [101A10019X](#) [105061100000861+](#) [75140-7012](#) [87471-650](#) [1744382-4](#) [063209](#) [10124054-515LF](#) [68685-603](#)
[8-1616154-3](#) [541371078](#) [IL-WX-10PB-HF-B-E1000E](#) [FX23-40P-0.5SV15B](#) [FCN-214J100-G/0](#) [354184](#) [P50-028-DDS-TG](#) [53309-2471](#)
[54546-2071](#) [1586617-1](#) [504248-1210](#) [504248-2010](#) [1-1437355-2](#) [9159005551906](#) [NDS100-004-BF](#) [93696-730LF](#) [91922-31141LF](#) [505274-](#)
[3440](#) [501493-2410](#) [504208-3410](#) [505006-0811](#) [505274-2040](#) [202436-1600](#) [202477-0414](#) [71660-7580](#) [73420-5192](#) [360-10-107-00-001000](#)