

For and on behalf of  
**XKB INDUSTRIAL PRECISION CO., LIMITED**  
 香港星坤工業精密有限公司

REVISIONS  
 Authorized Signatures(s)

MARK	DESCRIPTION	DATE	REVISED	APPROVED	UNSPECIFIED TOLERANCES
△ X					$L > 63$ $\pm 0.5$
△ X					$16 < L \leq 63$ $\pm 0.4$
△ X					$4 < L \leq 16$ $\pm 0.3$
△ X					$L \leq 4$ $\pm 0.2$
					ANGULAR $\pm 5^\circ$

REVISION	SHEET	WEIGHT	SCALE: N/A	DATE	DNSD	DATE	DWN	DATE	CHKD	DATE	APPD	DATE	SIZE: A4	REVISION
A0	1/1	1.0g												

MODEL TYPE: X1224WRS-XX-XXV01	PART NO.: 1.20mm Crimp Style Connectors	DWG NO.:
-------------------------------	---	----------

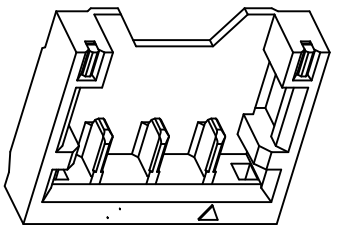
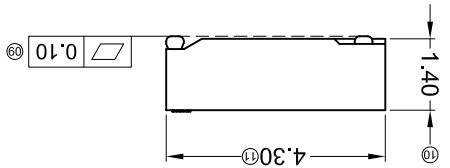
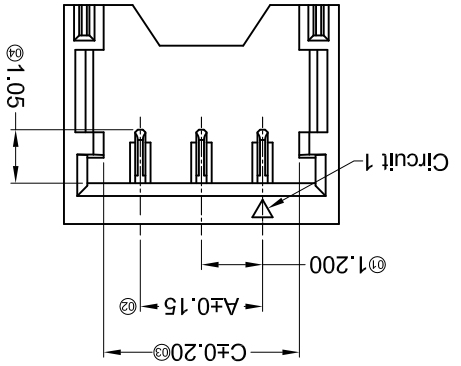
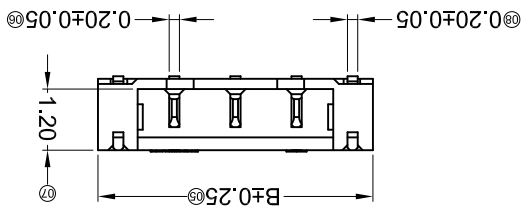
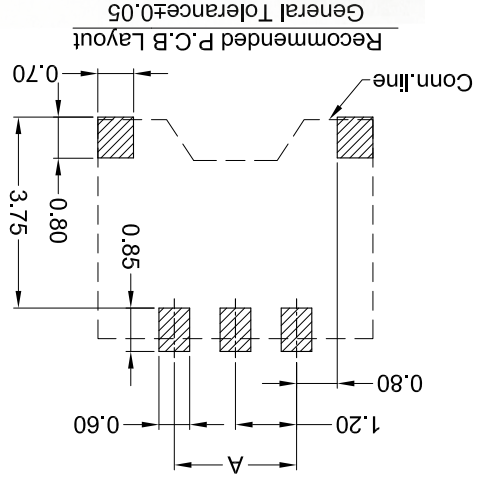

PART NO	Material	Material(Pin)	Finish(Pin)	(Solder Tabs) (Solder Tabs)	Material	Material	Finish	Material
X1224WRS-XX-LPV01	LCP UL 94V-0	Phosphos Bronze	Gold-Flash	Brass	Tin Plating Matte	Brass	Gold-Flash	Phosphos Bronze
PA4T UL 94V-0	Phosphos Bronze	Gold-Flash	Brass	Tin Plating Matte	Brass	Gold-Flash	Phosphos Bronze	Phosphos Bronze

Poles	Dimensions(mm)	
	A	B
02	1.20	4.20
03	2.40	5.40
		3.84

- 01 Series No.
- 02 Category: W-water
- 03 Welding Board Angle: R-Right Angle 90°
- 04 Welding Way: S-SMT
- 05 Row No.-Pin No.: XX-04P~07P
- 06 Plug the Pin & Special NO.:
- 07 Material: LP-LCP 94V-0 ; 4T-PA4T
- 08 Planting Category: V01: All Gold Flash
- 09 Color: Blank-Natural Color Black

X1224 W R S-XX X- XX V01 XX

- Voltage rating: 50V AC / DC
- Current rating: 2.0A AC / DC
- Withstanding voltage: 500V AC/minute
- Temperature range: -25°C~+85°C
- Insulation resistance: ≥100MΩ
- Contact resistance: ≤20mΩ
- After environmental testing: ≤40mΩ

■ Specifications :

For and on behalf of  
**XKB INDUSTRIAL PRECISION CO., LIMITED**  
 香港星坤工業精密有限公司

REVISIONS  
 Authorized Signature(s)

MARK	DESCRIPTION	DATE	REVISED	APPROVED	UNSPECIFIED TOLERANCES
△ X					±0.5
△ X					L > 63
△ X					16 < L ≤ 63
△ X					4 < L ≤ 16
△ X					L ≤ 4
					±0.2
					ANGULAR
					±5°

DSND	DATE	SCALE: N/A	MODEL TYPE: X1224T-PV01
APPD <td></td> <td></td> <td></td>			
CHKD <td></td> <td></td> <td></td>			
DWN <td></td> <td></td> <td></td>			

VIEW:	DATE	SCALE: N/A	MODEL TYPE: X1224T-PV01
UNIT: mm			
SIZE: A4			

REVISION	SHEET	WEIGHT	REVISION
1/1	1/1	1.0g	A0

PART NO	Material	Wire Range	Insulation O.D.	Finish	Suitable XKB Terminal
X1224T-PV01	Phosphor Bronze	AWG#28-30	0.70mm (Max.)	Stamping Before Plating: 30u" Ni:Whole Gold : Gold Flash	X1224H

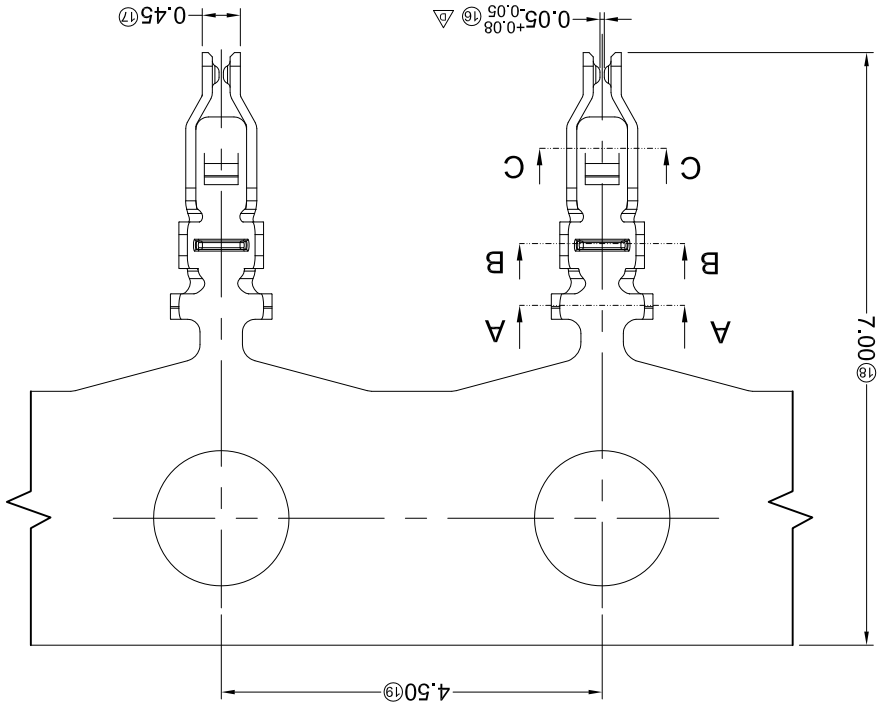
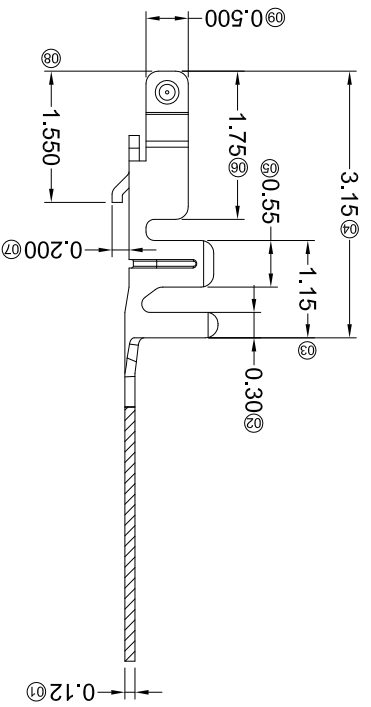
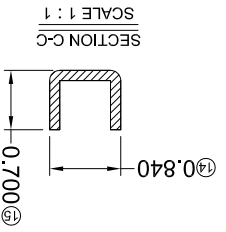
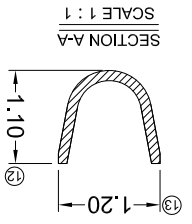
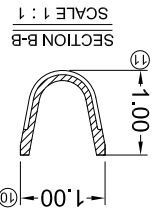
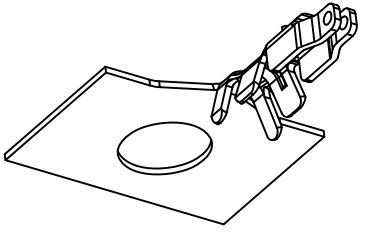

- Specifications :**
- Voltage rating: 50V AC / DC
  - Current rating: 2A AC / DC
  - Withstanding voltage: 500V AC/minute
  - Temperature range: -25°C~+85°C
  - Insulation resistance: ≥100MΩ
  - Contact resistance: ≤20mΩ
  - After environmental testing: ≤40mΩ
- Series Number: 01 02 03 04 05 06
- Category: T-terminal
- Shape: Blank-ordinary
- Material: P-Phosphor bronze
- Plating style: V01- All Gold Flash
- Plating method: 06
- Blank-Stamping before plating

X1224 T X-P V01 X

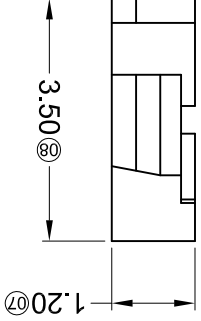
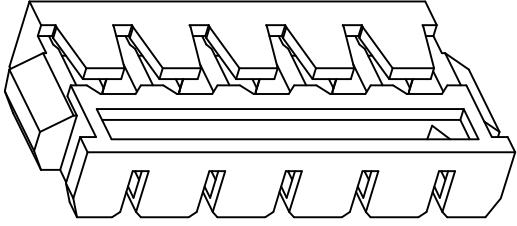
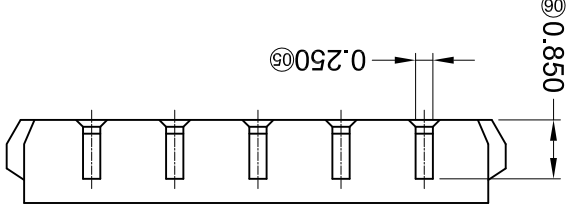
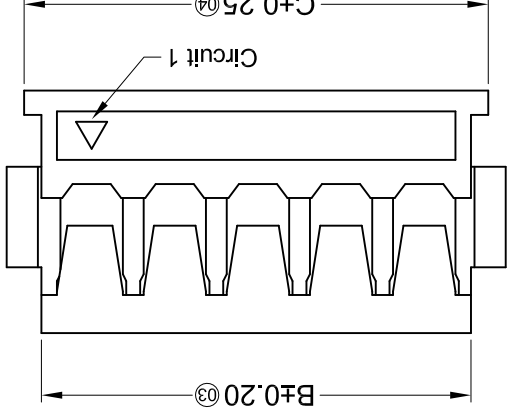
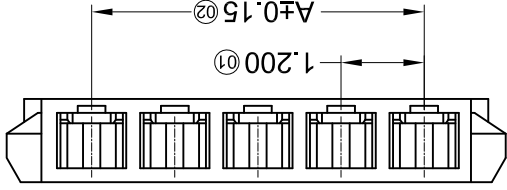

- Specifications :**
- Voltage rating: 50V AC / DC
  - Current rating: 2A AC / DC
  - Withstanding voltage: 500V AC/minute
  - Temperature range: -25°C~+85°C
  - Insulation resistance: ≥100MΩ
  - Contact resistance: ≤20mΩ
  - After environmental testing: ≤40mΩ

X1224 H X-XX HF-XX XX

- ① Series No.
- ② Category: H-HSG
- ③ Welding Board Angle: Blank-ordinary
- ④ Row No.-Pin No.: XX-02P~05P
- ⑤ Plug the Pin & special No.: HF-Halogen free
- ⑥ Material: 46-PA46 94V-0; LP-LCP
- ⑦ Color: Blank-Natural Color Black

Poles	Dimensions(mm)		
	A	B	C
02	1.20	2.60	3.10
03	2.40	3.80	4.30
04	3.60	5.00	5.50
05	4.80	6.20	6.70

PART NO	Material	Suitable XKB Terminal	Suitable XKB Terminal
X1224H-XX-46	PA 46 UL 94V-0	X1224T	X1224W
X1224H-XX-LP	LCP UL 94V-0		
X1224H-XXHF-LP	LCP UL 94V-0 Halogen Free		

MARK	DESCRIPTION	DATE	REVISED	APPROVED	UNSPECIFIED TOLERANCES	
					L > 63	±0.5
△ X					16 < L ≤ 63	±0.4
△ X					4 < L ≤ 16	±0.3
△ X					L ≤ 4	±0.2
					ANGULAR	±5°

For and on behalf of  
**XKB INDUSTRIAL PRECISION CO., LIMITED**  
 香港星坤工業精密有限公司

REVISIONS  
 Authorized Signature(s)

DSND	DATE	SCALE: N/A	MODEL TYPE: X1224H-XXHF-XX
DWN	DATE <td>VIEW: </td> <td>PART NO.:</td>	VIEW:	PART NO.:
CHKD	DATE <td>UNIT: mm</td> <td>DWG NO.:</td>	UNIT: mm	DWG NO.:
APPD	DATE <td>SIZE: A4</td> <td></td>	SIZE: A4	
		WEIGHT: 1.0g	REVISION: A0
		SHEET: 1/1	

**XKB INDUSTRIAL PRECISION CO., LIMITED**

## X-ON Electronics

Largest Supplier of Electrical and Electronic Components

*Click to view similar products for [Headers & Wire Housings](#) category:*

*Click to view products by [XKB](#) manufacturer:*

Other Similar products are found below :

[95000-104TRLF](#) [10135584-644402LF](#) [DF62W-EP2022PCA](#) [95000-106TRLF](#) [DF62W-2022SCA](#) [DF62W-EP2022PC](#) [2203348](#) [DF62W-2022SC](#) [1084018](#) [1029039](#) [1084017](#) [802-10-012-10-002000](#) [1112640](#) [1112639](#) [891-007-9SS-BST1T](#) [000-34000](#) [0008550134](#) [0009482033](#) [0009507031](#) [57102-F02-18ULF](#) [57102-S06-03LF](#) [57202-S52-04LF](#) [PCN6-15S-2.5E](#) [0039019024](#) [58102-G61-06LF](#) [582553-1](#) [0009485154](#) [0009508121](#) [0022285053](#) [0050291907](#) [018731A](#) [LY20-4P-DT1-P1E-BR](#) [02.125.8002.8](#) [60101931](#) [60598-1 \(Cut Strip\)](#) [M1625-3R/100](#) [61062-3](#) [61082-181009](#) [CSU011177004](#) [636-1427](#) [638009-1](#) [641938-9](#) [641991-4](#) [644168-1](#) [644827-2](#) [647662-1](#) [65039-019ELF](#) [65692-001LF](#) [65781-018](#) [65781-047](#)