

广东星坤科技股份有限公司

ΔX		日期
ΔX		日期
ΔX		日期
MARK		

文件工程章

REVISIONS	DESCRIPTION	DATE	REVISED	APPROVED	UNSPECIFIED TOLERANCES

ANGULAR	±5°
L ≤ 4	±0.2
4 < L ≤ 16	±0.3
16 < L ≤ 63	±0.4
L > 63	±0.5

DSND	SCALE: N/A	MODEL TYPE:
DWN	VIEW:	PART NO.: X1302WVS-67XX-LPV01
CHKD	UNIT: mm/in	DWG NO.: X-X1302WVS-67XX-LPV01
APPD	SIZE: A4	WEIGHT SHEET REVISION
XKB INDUSTRIAL PRECISION CO., LIMITED		1/1 A0



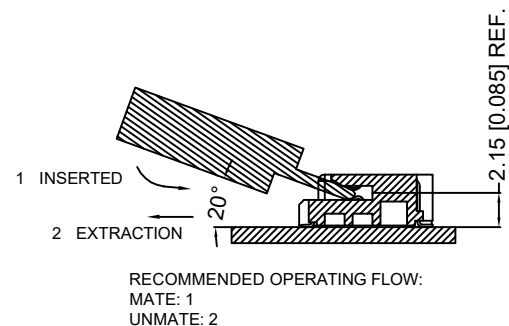
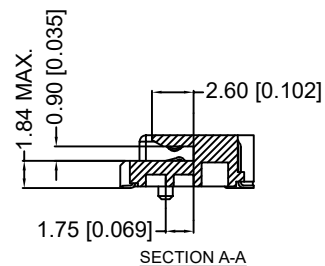
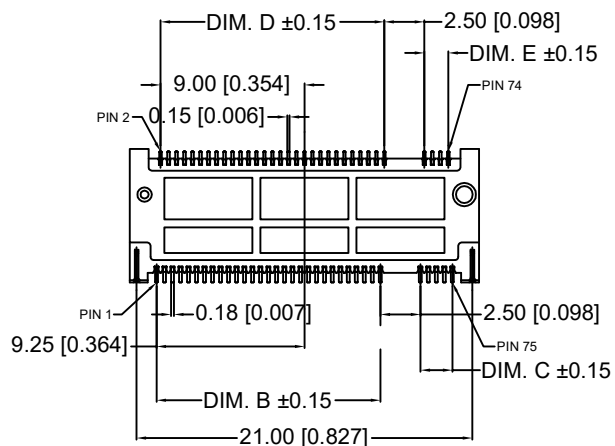
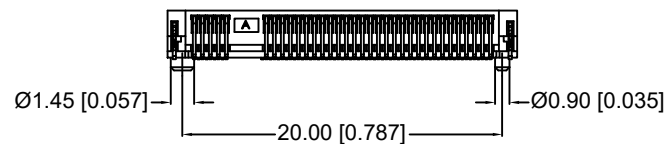
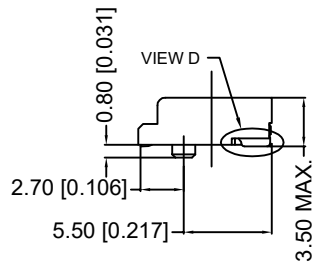
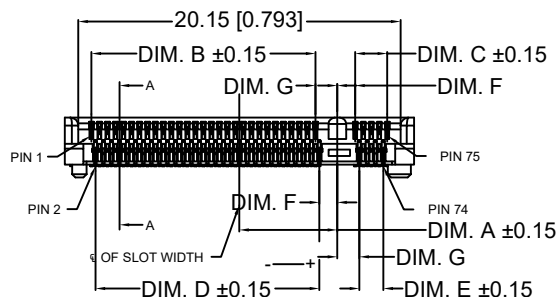
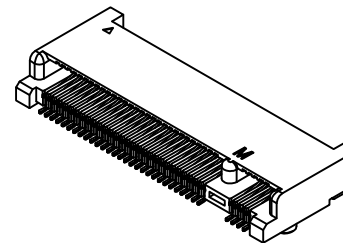
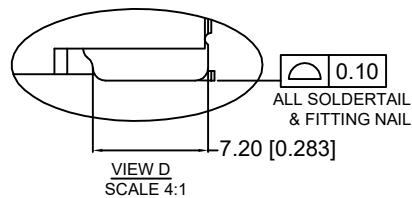
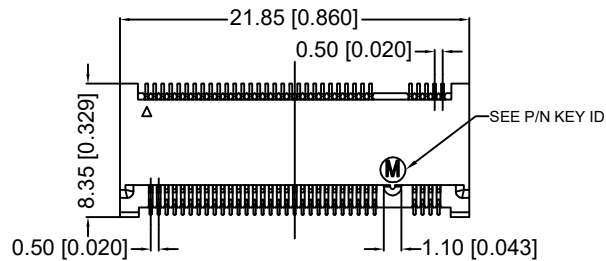

ΔX						ANGLAR	±5°
ΔX						L ≤ 4	±0.2
ΔX						4 < L ≤ 16	±0.3
MARK	DESCRIPTION	DATE	REVISED	APPROVED		16 < L ≤ 63	±0.4
	REVISIONS					L > 63	±0.5
	www.helloxkb.com www.helloxkb.cn www.xk-dg.cn					UNSPECIFIED TOLERANCES	



DSND		SCALE: N/A	MODEL TYPE:
DWN		VIEW:	PART NO.:
CHKD		UNIT: mm/in	X1302WVS-67XX-LPVC
APPD		SIZE: A4	DWG NO.:
			X-X1302WVS-67XX-LPV01
			WEIGHT
			SHEET
			REVISIC
			1/1
			A0

XKB INDUSTRIAL PRECISION CO., LIMITED

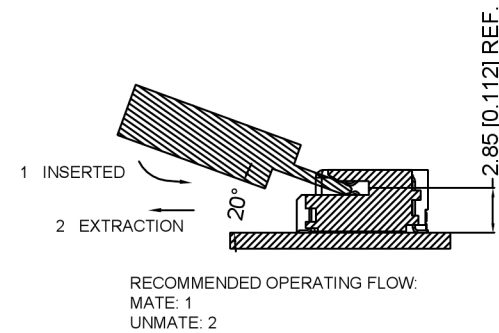
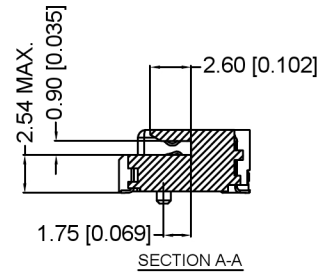
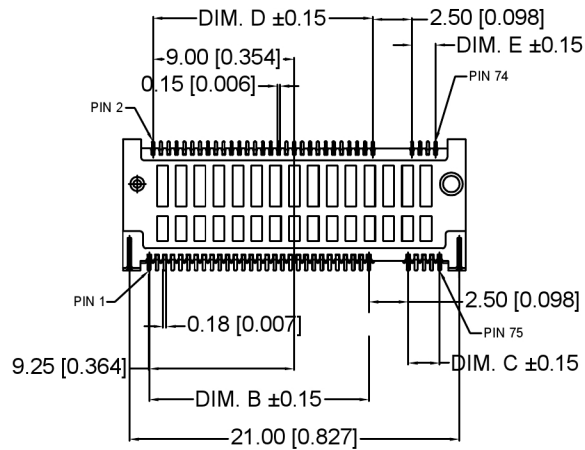
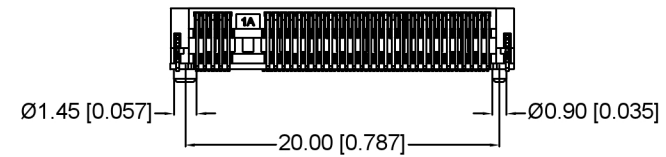
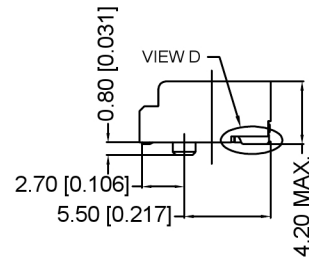
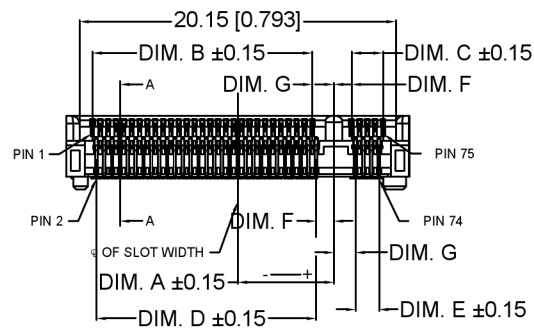
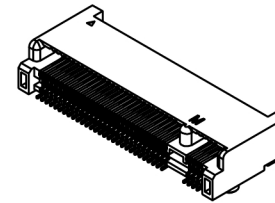
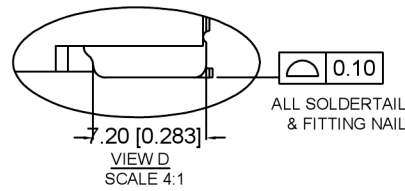
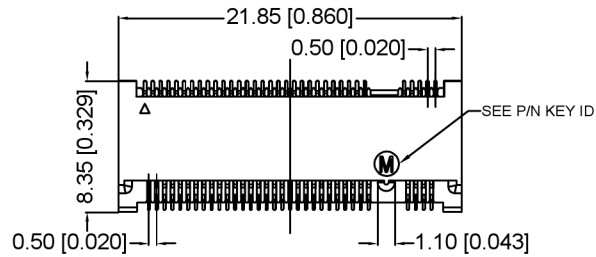

广东星坤科技股份有限公司
 生效日期
 文件工程章

NO.	DESCRIPTION	DATE	REVISED	APPROVED	UNSPECIFIED TOLERANCES
1	ANGULAR				±5°
2	L ≤ 4				±0.2
3	4 < L ≤ 16				±0.3
4	16 < L ≤ 63				±0.4
5	L > 63				±0.5

DSND	SCALE: N/A	MODEL TYPE:
DWN	VIEW:	PART NO.: X1302WVS-67XX-LPV01
CHKD	UNIT: mm/in	DWG NO.:
APPD	SIZE: A4	X-X1302WVS-67XX-LPV01
KXB INDUSTRIAL PRECISION CO., LIMITED		WEIGHT SHEET REVISION
		1/1 A0

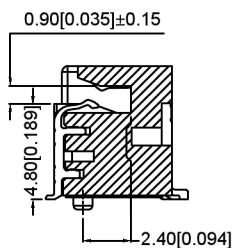
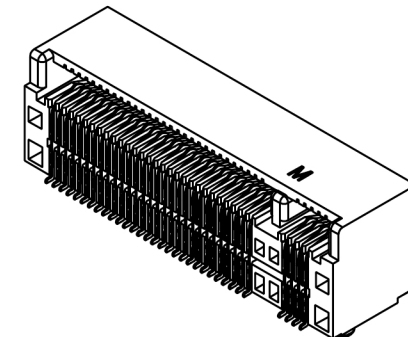
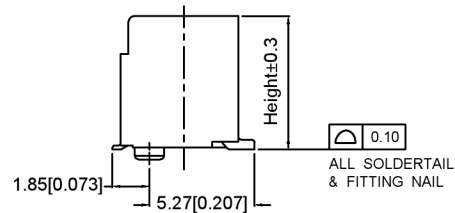
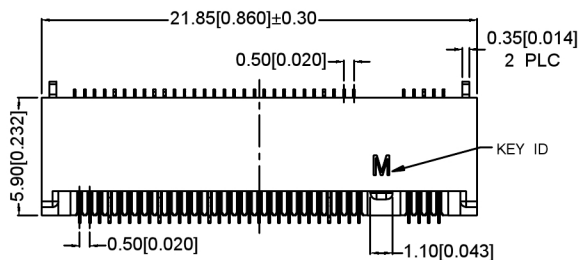

SECTION A-A

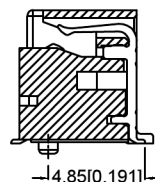

SECTION B-B

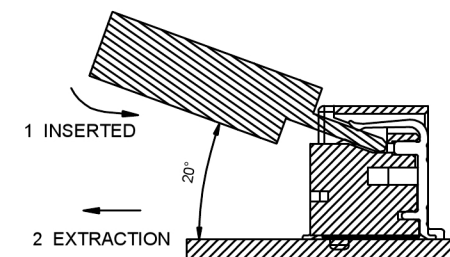
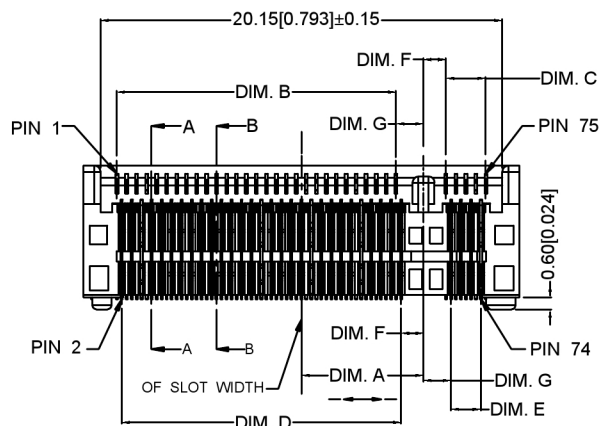
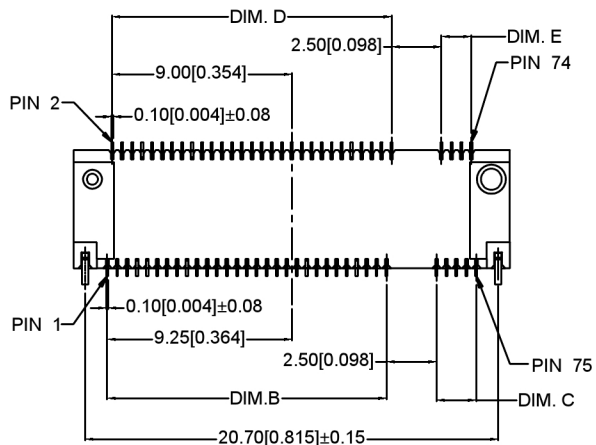
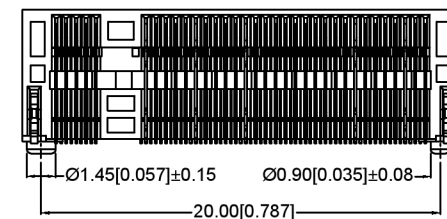

RECOMMENDED OPERATING FLOW:
MATE: 1
UNMATE: 2

广东星坤科技股份有限公司

Δ#	日期
ΔX	日期
ΔX	日期
MARK	DESCRIPTION
文件	工程章

MARK	DESCRIPTION	DATE	REVISED	APPROVED	UNSPECIFIED TOLERANCES
	REVISIONS				
					ANGULAR ±5°
					L ≤ 4 ±0.2
					4 < L ≤ 16 ±0.3
					16 < L ≤ 63 ±0.4
					L > 63 ±0.5



DSND	SCALE: N/A	MODEL TYPE:
DWN	VIEW:	PART NO.: X1302WVS-67XX-LPV01
CHKD	UNIT: mm/in	DWG NO.: X-X1302WVS-67XX-LPV01
APPD	SIZE: A4	WEIGHT SHEET REVISION
XKB INDUSTRIAL PRECISION CO., LIMITED		1/1 A0

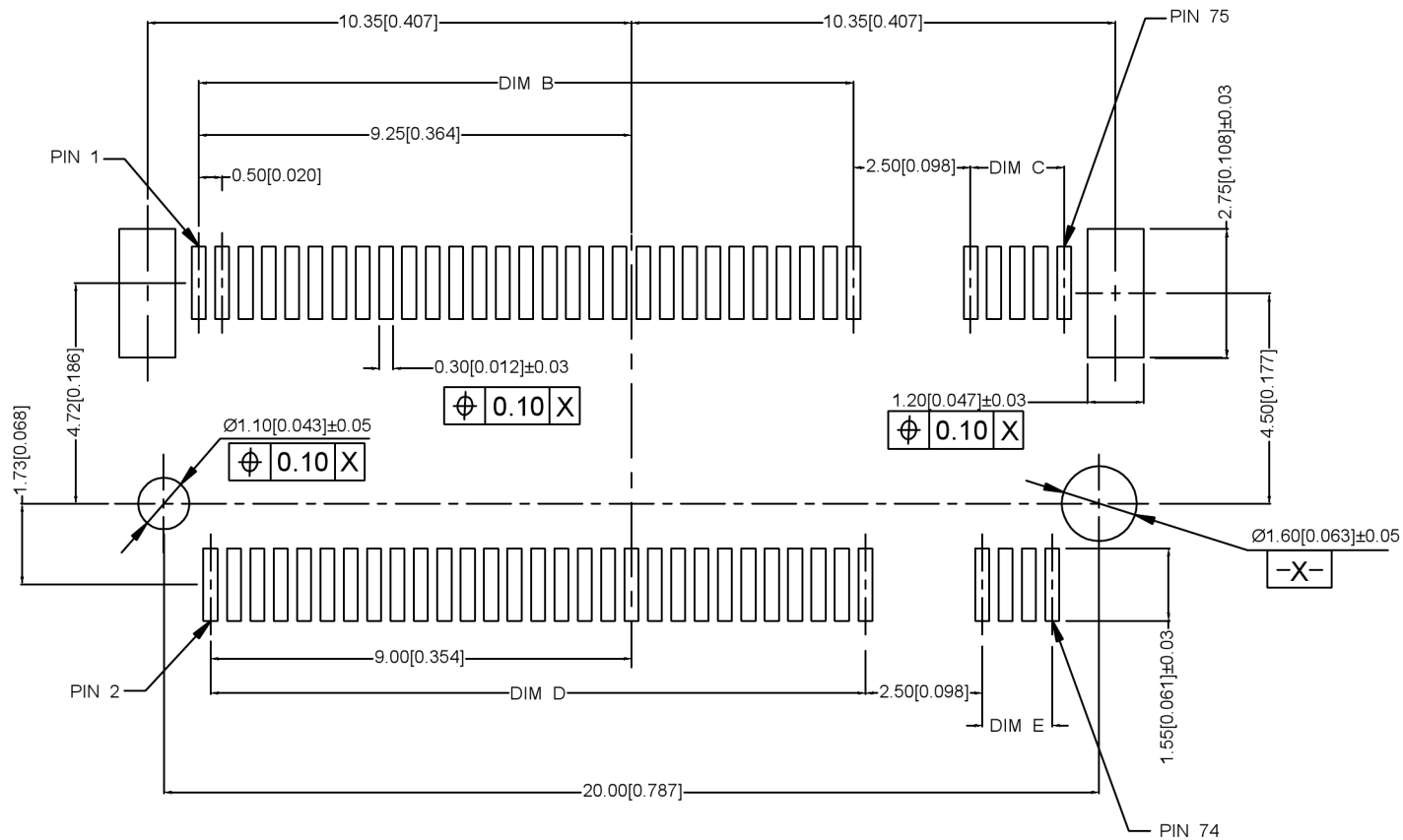

广东星坤科技股份有限公司

文件工程章

MARK	DESCRIPTION	DATE	REVISED	APPROVED	UNSPECIFIED TOLERANCES
Δ*	日期				ANGLAR ±5°
Δ*					L ≤ 4 ±0.2
Δ*					4 < L ≤ 16 ±0.3
					16 < L ≤ 63 ±0.4
					L > 63 ±0.5



DSND	SCALE: N/A	MODEL TYPE:
DWN	VIEW:	PART NO.: X1302WVS-67XX-LPV01
CHKD	UNIT: mm/in	DWG NO.: X-X1302WVS-67XX-LPV01
APPD	SIZE: A4	WEIGHT SHEET REVISION
		1/1 A0

XKB INDUSTRIAL PRECISION CO., LIMITED

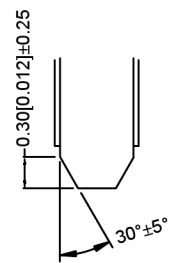
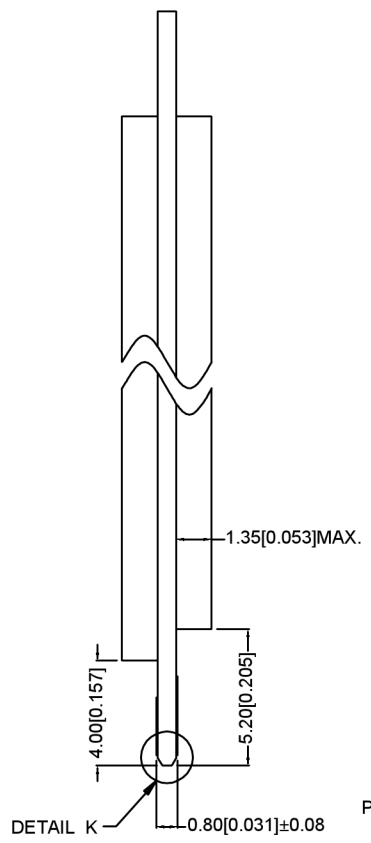
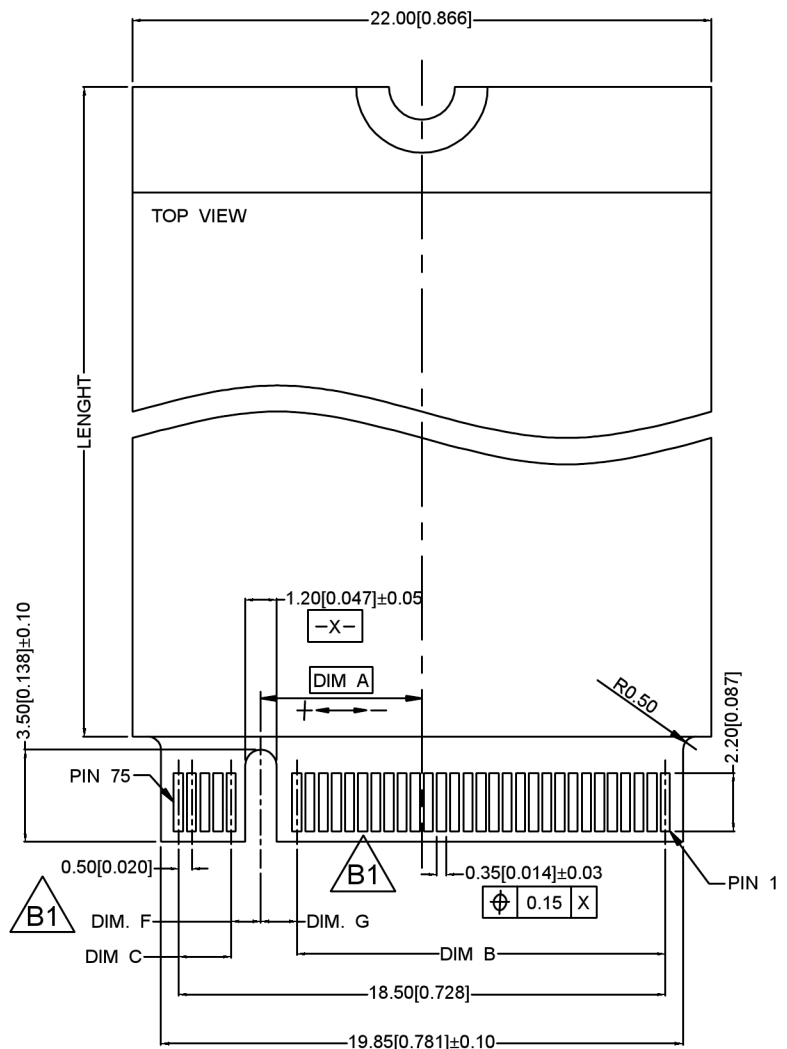

DETAIL K
SCALE 4:1

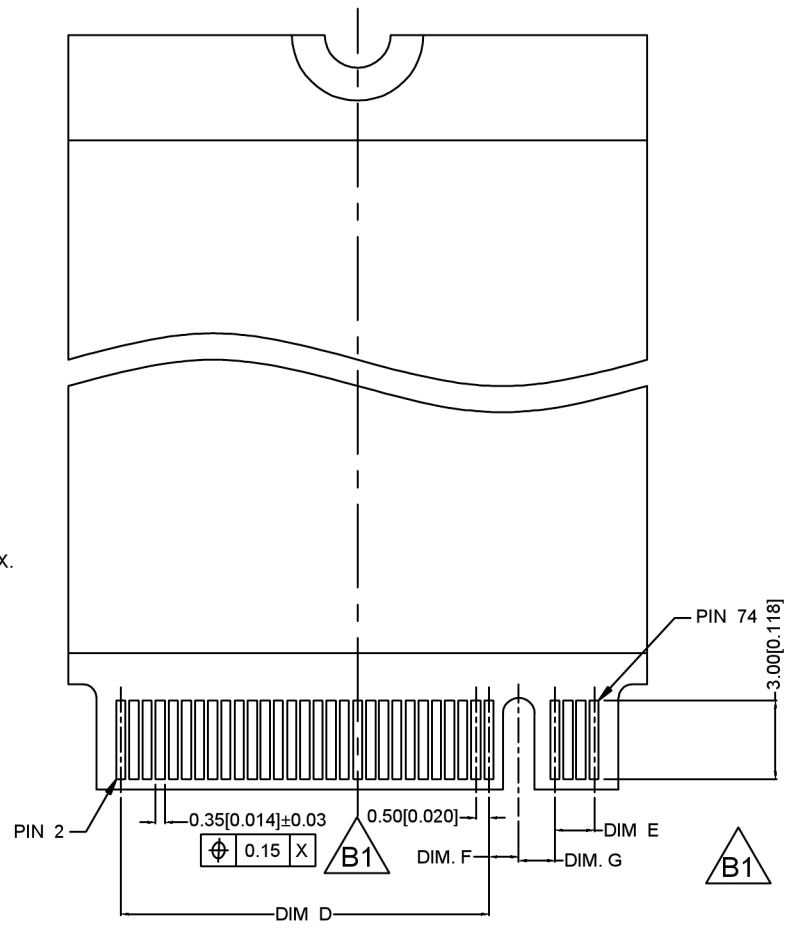

广东星坤科技股份有限公司

Δ建	日期
Δ改	日期
ΔX	

文件工程章

MARK	DESCRIPTION	DATE	REVISED	APPROVED	UNSPECIFIED TOLERANCES
	REVISIONS				
					ANGULAR ±5°
					L ≤ 4 ±0.2
					4 < L ≤ 16 ±0.3
					16 < L ≤ 63 ±0.4
					L > 63 ±0.5



DSND	SCALE: N/A	MODEL TYPE:
DWN	VIEW:	PART NO.: X1302WWS-67XX-LPV01
CHKD	UNIT: mm/in	DWG NO.: X-X1302WWS-67XX-LPV01
APPD	SIZE: A4	
KXB INDUSTRIAL PRECISION CO., LIMITED		WEIGHT SHEET REVISION
		1/1 A0

NOTES 注释:

1. MATERIAL材料:

1.1 HOUSING外壳: THERMOPLASTIC, HIGH TEMP.,
UL94V-0;
COLOR: BLACK.

1.2 CONTACTS触点: COPPER ALLOY.

1.3 FITTING NAIL装配钉: COPPER ALLOY.

2. FINISH饰面:

2.1 CONTACT触点:

[SEE TABLE] GOLD PLATING ON THE CONTACT AREA.
GOLD FLASH PLATING ON THE SOLDERING AREA.

1.27um~2.54um [50u"~100u"] MIN. NICKEL UNDERPLATING OVERALL

2.2 FITTING NAIL装配钉:

2.54um~5.08um [100u"~200u"] MIN. MATTE-TIN PLATING
ON THE SOLDERING AREA

1.27um~2.54um [50u"~100u"] MIN. NICKEL UNDERPLATING OVERALL.

X1302 W V S - 67 X X - LP V01

① ② ③ ④ ⑤ ⑥ ⑦ ⑧ ⑨

① Series Number

② Terminal form: W-Wafer

③ Welding Board Angle : V-Stright Angle 180°

④ Welding Way:S-SMT

⑤ No.of Pins: XX-67 PIN

⑥ HEIGHT: A 3.2mm;B 3.5mm;C 4.2mm;
D 5.5mm;E 6.7mm;F 8.5mm

⑦ KEY ID: A,B,C,D,E,F,G,H,J,K,L,M

⑧ Plastic material: LP-LCP UL94V-0

⑨ Contact Plating:V01-Gold Flash
V15 -Gold 15"u"
V30 -Gold 30"u"



1.375	1.125	1.5	14.0	2.0	14.0	6.125	M
1.375	1.125	2.5	13.0	3.0	13.0	5.125	L
1.375	1.125	3.5	12.0	4.0	12.0	4.125	K
1.375	1.125	4.5	11.0	5.0	11.0	3.125	J
1.375	1.125	5.5	10.0	6.0	10.0	2.125	H
1.375	1.125	6.5	9.0	7.0	9.0	1.125	G
DIM. G	DIM. F	DIM. E	DIM. D	DIM. C	DIM. B	DIM. A	KEY ID



1.125	1.375	9.5	6.0	9.5	6.5	-1.625	F
1.125	1.375	10.5	5.0	10.5	5.5	-2.625	E
1.125	1.375	11.5	4.0	11.5	4.5	-3.625	D
1.125	1.375	12.5	3.0	12.5	3.5	-4.625	C
1.125	1.375	13.5	2.0	13.5	2.5	-5.625	B
1.125	1.375	14.5	1.0	14.5	1.5	-6.625	A
DIM. G	DIM. F	DIM. E	DIM. D	DIM. C	DIM. B	DIM. A	KEY ID

广东星坤科技股份有限公司

姓名	日期
数量	日期
MARK	DESCRIPTION
文件	工程章

MARK	DESCRIPTION	DATE	REVISED	APPROVED	UNSPECIFIED TOLERANCES
					ANGULAR ±5°
					L ≤ 4 ±0.2
					4 < L ≤ 16 ±0.3
					16 < L ≤ 63 ±0.4
					L > 63 ±0.5



DSND	SCALE: N/A	MODEL TYPE:
DWN	VIEW:	PART NO.: X1302WVS-67XX-LPV01
CHKD	UNIT: mm/in	DWG NO.: X-X1302WVS-67XX-LPV01
APPD	SIZE: A4	WEIGHT SHEET REVISION
XKB INDUSTRIAL PRECISION CO., LIMITED		1/1 A0

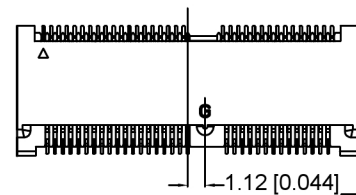
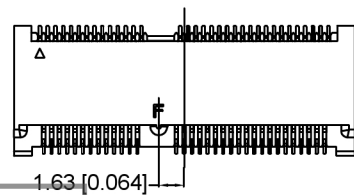
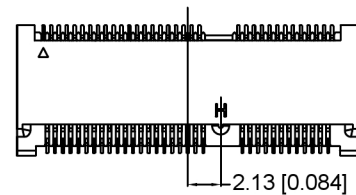
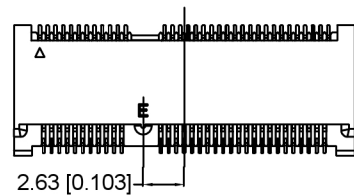
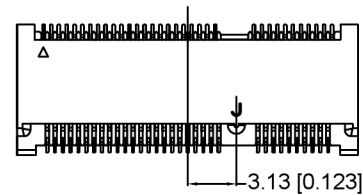
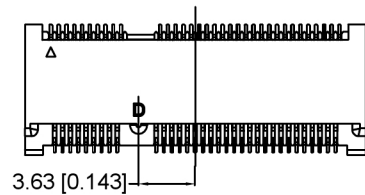
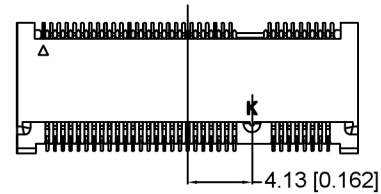
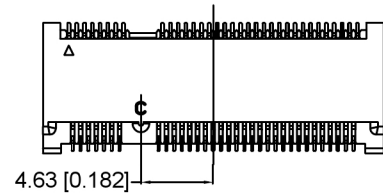
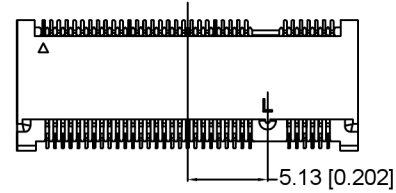
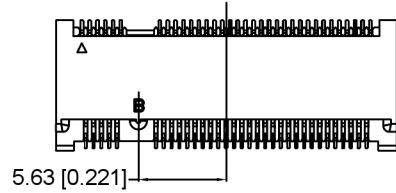
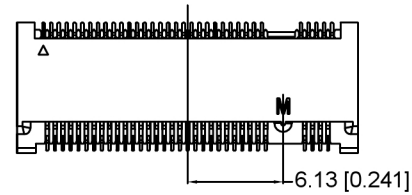
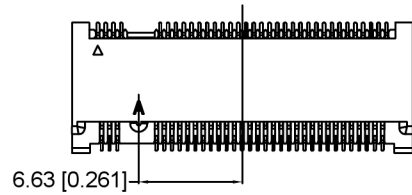

广东星坤科技股份有限公司

生效日期

文件工程章

NO.	DESCRIPTION	DATE	REVISED	APPROVED	UNSPECIFIED TOLERANCES
					ANGULAR ±5°
					L ≤ 4 ±0.2
					4 < L ≤ 16 ±0.3
					16 < L ≤ 63 ±0.4
					L > 63 ±0.5

DSND		SCALE: N/A	MODEL TYPE:
DWN		VIEW:	PART NO.: X1302WWS-67XX-LPV01
CHKD		UNIT: mm/in	DWG NO.: X-X1302WWS-67XX-LPV01
APPD		SIZE: A4	WEIGHT SHEET REVISION
XKB INDUSTRIAL PRECISION CO., LIMITED			1/1 A0



X-ON Electronics

Largest Supplier of Electrical and Electronic Components

Click to view similar products for [I/O Connectors](#) category:

Click to view products by [XKB](#) manufacturer:

Other Similar products are found below :

[571763P](#) [59811-0000](#) [61-168618-12P](#) [D20419-211](#) [76871-1403](#) [PCR-E36PM](#) [PCS-XE26LKA](#) [PCS-XES68MS+](#) [G38A71314B](#) [DX40-50P\(55\)](#) [1571250010](#) [157-22500-3](#) [192991-0703](#) [SM3100RC14S-9P-115](#) [FCN-260C008-A/L0](#) [FCN-260C024-AL0](#) [FCN-261Z008](#) [2000314-1](#) [200331-1](#) [PCS-E28FS+](#) [PCS-XE26SLFDT+](#) [G730VID08BDC24](#) [HDR-E14MSG1+](#) [54182-0605](#) [UE86K842720321](#) [DP3AR020WQ1R200](#) [DRA-26PC-F0R](#) [Z4.102.0680.0](#) [500-1040](#) [500-1052](#) [ZP-4008-66L](#) [DX40-20P\(55\)](#) [5554841-1](#) [SM3100F14S-12P](#) [U90B3054061110](#) [U65-E04-4020](#) [557-262M2-06C](#) [60-042222-02S](#) [10099439-003C-TRLF](#) [226-0348-000](#) [10137239-0011LF](#) [70.060.1028.0](#) [109029-ZZ](#) [HDR-E26MG1+](#) [SO-0715-02-01-02](#) [GT1-DA04CST](#) [91-569769-35P](#) [231-303](#) [MS3112E16-8SX](#) [91-569767-35P](#)