

广东星坤科技股份有限公司

日期

文件工程章

MARK	DESCRIPTION	DATE	REVISED	APPROVED	UNSPECIFIED TOLERANCES
Δ*					ANGLAR ±5°
Δx					L ≤ 4 ±0.2
Δx					4 < L ≤ 16 ±0.3
					16 < L ≤ 63 ±0.4
					L > 63 ±0.5
REVISIONS					UNSPECIFIED TOLERANCES
www.helloxkb.com www.helloxkb.cn www.xk-dg.cn					



DSND	SCALE: N/A	MODEL TYPE:
DWN	VIEW:	PART NO.: X1304WWS-52X-LPV10
CHKD	UNIT: mm/in	DWG NO.:
APPD	SIZE: A4	X-X1304WWS-52X-LPV10
XKB INDUSTRIAL PRECISION CO., LIMITED		WEIGHT SHEET REVISION
		1/1 A0

NOTES 注释:

1. MATERIAL 材料:

HOUSING 外壳: THERMOPLASTIC, HIGH TEMP.,  
UL94V-0; BLACK COLOR

CONTACTS 触点: COPPER ALLOY.

PEGS 螺钉: COPPER ALLOY.

2. FINISH 饰面:

CONTACT 触点: SELECTIVE GOLD PLATING ON CONTACT AREA.  
100μ" MIN. MATTE TIN PLATING ON SOLDER TAILS,  
50μ" MIN. NICKEL UNDERPLATING OVERALL.

PEGS 螺钉: 120u" MIN. MATTE-TIN OVER 50u" MIN. NICKEL.

X1304 W V S - 52 X - LP V10

① ② ③ ④ ⑤ ⑥ ⑦ ⑧

① Series Number

② Terminal form: W-Wafer

③ Welding Board Angle : V-Stright Angle 180°

④ Welding Way: S-SMT

⑤ No. of Pins: 52 PIN

⑥ HEIGHT: A 4.0mm; B 5.2mm; C 5.6mm; D 6.8mm;  
E 7.0mm; F 8.0mm; G 9.0mm; H 9.9mm

⑦ Plastic material: LP-LCP UL94V-0

⑧ Contact Plating: V01-Gold Flash  
V10-Gold 10 u"  
V30-Gold 30 u"

广东星坤科技股份有限公司

Δ	日期
Δ	
Δ	
MARK	文件工程章

MARK	DESCRIPTION	DATE	REVISED	APPROVED	ANGLAR	±5°
					L ≤ 4	±0.2
					4 < L ≤ 16	±0.3
					16 < L ≤ 63	±0.4
					L > 63	±0.5
REVISIONS					UNSPECIFIED TOLERANCES	

DSND	SCALE: N/A	MODEL TYPE:
DWN	VIEW:	PART NO.: X1304WVS-52X-LPV10
CHKD	UNIT: mm/in	DWG NO.: X-X1304WVS-52X-LPV10
APPD	SIZE: A4	WEIGHT
XKB INDUSTRIAL PRECISION CO., LIMITED		SHEET 1/1
		REVISION A0



COMPONENT KEEP OUT AREA FOR  
CARD HOLD DOWN SOLUTION

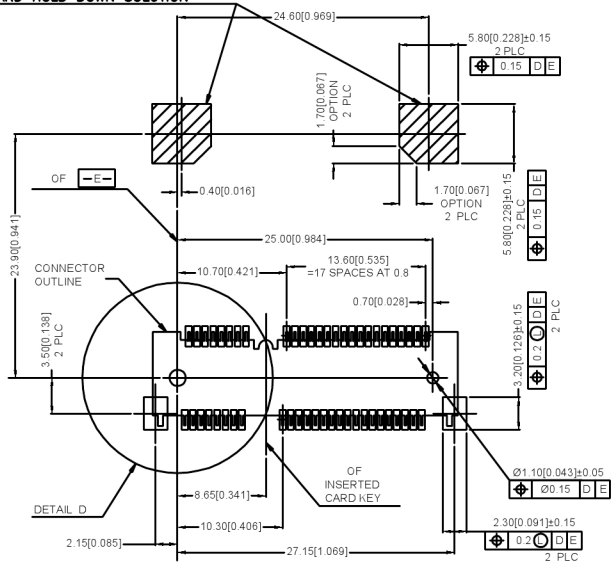

—D— IS THE TOP SURFACE OF PCB.  
RECOMMENDED P.C. BOARD PATTERN LAYOUT  
FOR HALF CARD CONNECTOR  
(TOP VIEW)

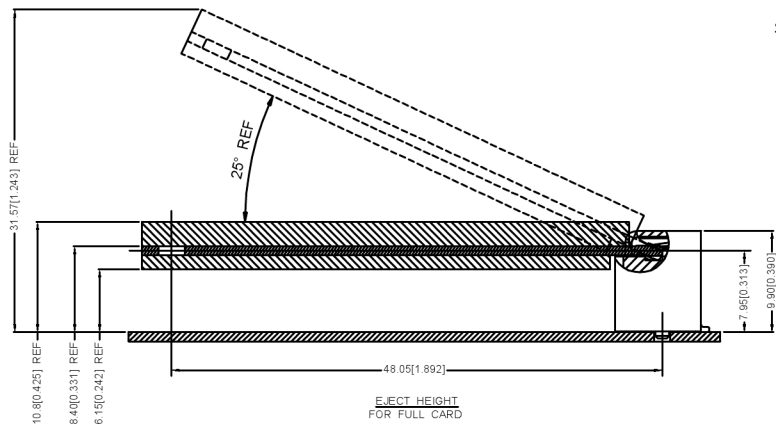

EJECT HEIGHT  
FOR FULL CARD

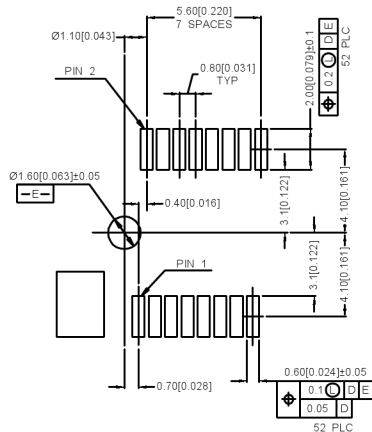

DETAIL D  
SCALE 2:1

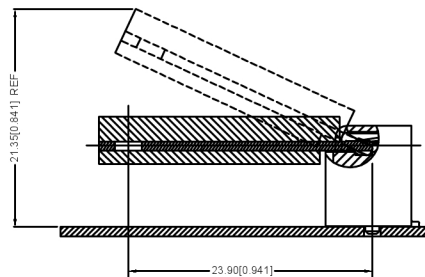

EJECT HEIGHT  
FOR HALF CARD

COMPONENT KEEP OUT AREA FOR  
CARD HOLD DOWN SOLUTION

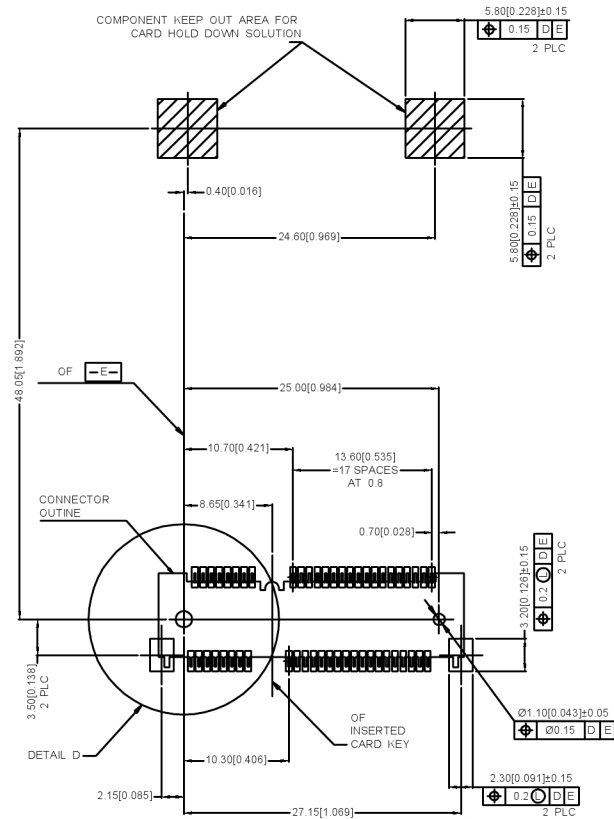

—D— IS THE TOP SURFACE OF PCB.  
RECOMMENDED P.C. BOARD PATTERN LAYOUT  
FOR HALF CARD CONNECTOR  
(TOP VIEW)

广东星坤科技股份有限公司

Δ建	日期
Δ改	日期
ΔX	
MARK	DESCRIPTION

						ANGLAR	±5°
						L ≤ 4	±0.2
						4 < L ≤ 16	±0.3
						16 < L ≤ 63	±0.4
						L > 63	±0.5
						UNSPECIFIED TOLERANCES	

XKLB

DSND	SCALE: N/A	MODEL TYPE:
DWN	VIEW:	PART NO.: X1304WVS-52X-LPV10
CHKD	UNIT: mm/in	DWG NO.:
APPD	SIZE: A4	X-X1304WVS-52X-LPV10
	WEIGHT	SHEET
		REVISION

XKB INDUSTRIAL PRECISION CO., LIMITED



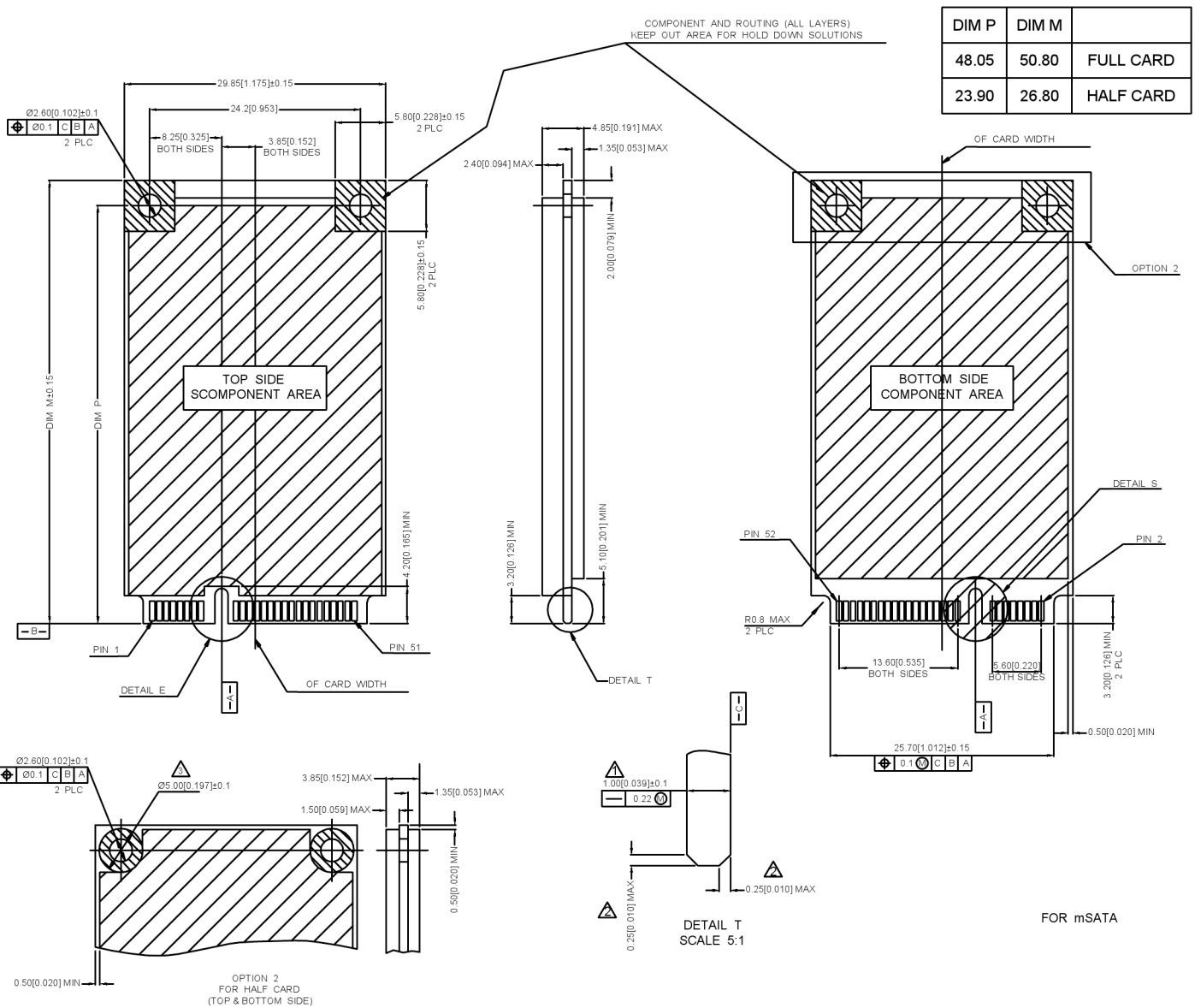

DIM P	DIM M	
48.05	50.80	FULL CARD
23.90	26.80	HALF CARD

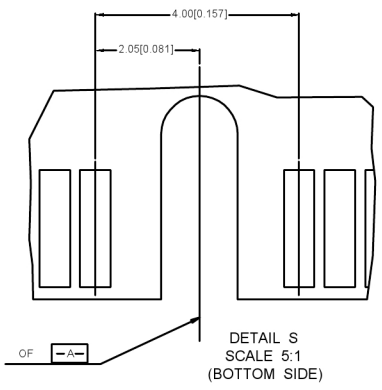
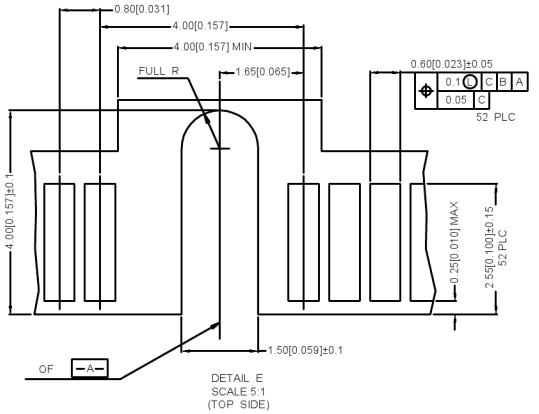

- NOTES 注释:
- △ CARD THICKNESS APPLIES ACROSS TABS AND INCLUDES PLATING AND/OR METALLIZATION.  
卡片厚度适用于所有接线片，包括电镀和/或金属化。
  - △ EDGE BEVEL MUST BE IPRESENT AND FREE OF CUTTING CONTACT MATERIALS BURRS FROM AND PCB  
边缘斜面必须均匀且无切割接触材料毛刺和PCB
  - △ COMPONENT AND ROUTING (TOP/BOTTOM LAYER) KEEP OUT AREA FOR HOLD DOWN SOLUTIONS.  
元件和布线(顶层/底层)为压紧解决方案留出区域

广东星坤科技股份有限公司

姓名	日期
数量	日期
MARK	DESCRIPTION

DATE	REVISED	APPROVED	UNSPECIFIED TOLERANCES
ANGLAR	±5°		
L ≤ 4	±0.2		
4 < L ≤ 16	±0.3		
16 < L ≤ 63	±0.4		
L > 63	±0.5		



DSND	SCALE: N/A	MODEL TYPE:
DWN	VIEW:	PART NO.: X1304WVS-52X-LPV10
CHKD	UNIT: mm/in	DWG NO.: X-X1304WVS-52X-LPV10
APPD	SIZE: A4	WEIGHT SHEET REVISION
		1/1 A0

文件工程章

## X-ON Electronics

Largest Supplier of Electrical and Electronic Components

*Click to view similar products for [XKB](#) manufacturer:*

Other Similar products are found below :

[TC-1103-C-B](#) [TC-FS66D-C-A](#) [XKNANO-1307-16](#) [X9396WR-04-N0SN](#) [X9396WR-06-N0SN](#) [X0800WRS-06HF-LPV01](#) [U221-046N-4BU02-FS](#) [X3025WV-02-N0SN](#) [DC-0130-2.5A-2.0](#) [DC-0130-2.5A-2.5](#) [X6511WR-23H-C30D60-R2](#) [DF1-1365UNY-1](#) [XKB5858-Z-F-75](#) [X2011H-05A-N0](#) [X9821H-13A-N0](#) [U263-241N-4BQC13](#) [X6511WVS-12H-C60D48R2](#) [X6511WR-10H-C30D60R2](#) [X1270WVS-2x20A-6TV01](#) [TGG.0B.P04.CLAD52H](#) [ZGG.3K.P12.CLN](#) [ZGG.3K.P12.CLL](#) [ZGG.1K.P02.CLN](#) [ZEG.2K.P02.CLL](#) [ZCG.1B.P16.CLL](#) [TGG.2K.P02.CLAC50](#) [ZEG.3K.P12.CLN](#) [ZEG.2K.P12.CLN](#) [USB31-TYPE-C-FSABC](#) [X0510FVS-168AS-LPV01](#) [MHG.3K.P02.CLLC90H](#) [X6511FRS-05-C85D30](#) [X2001HA-PTAuN-A28B50-X2001HA-PTAuN-IDC](#) [X0709FT7BL1-A28G10-X9555H2-PTV01-IDC](#) [X2513WR-2x06A-LPSN](#) [PJ-3026](#) [TS-1101S-C-B-B-B](#) [SK-3390A-L1](#) [X05A20L17T](#) [TC-1102T-B](#) [X0800WRS-05HF-LPV01](#) [X1502WR-13K-N0SN](#) [U261-2422N-4B0178](#) [SS-3292S-L1-B](#) [X6511WR-04H-C30D60R2](#) [X9821WVS-16-9TSN](#) [X6511WR-03H-C30D60R2](#) [X1311FVS-05-C43D35R2](#) [X1311FR-02-C43D24](#) [X9821H-05A-N0](#)