

DIMENSIONS				
POSITION	A ±0.20	C ±0.25	D ±0.25	E ±0.35
36	6	12.3	25	34.8
64	20	26.3	39	48.8
98	37	43.3	56	65.8
164	70	76.3	89	98.8

PCB Thickness "DIM. K"	DIM.M
0	2.08
1	2.30
2	1.80
4	1.57

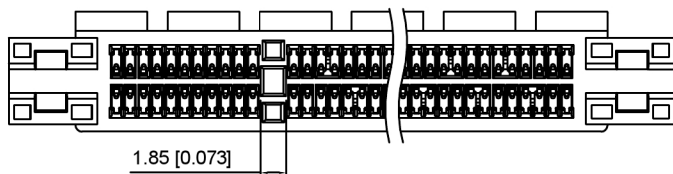
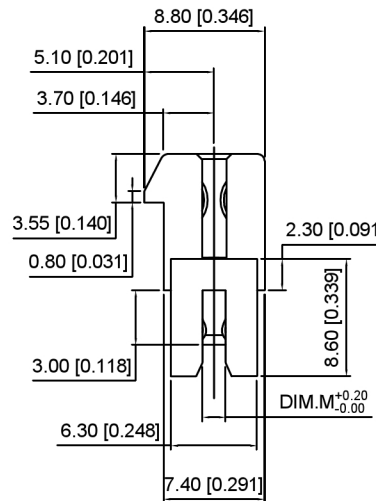
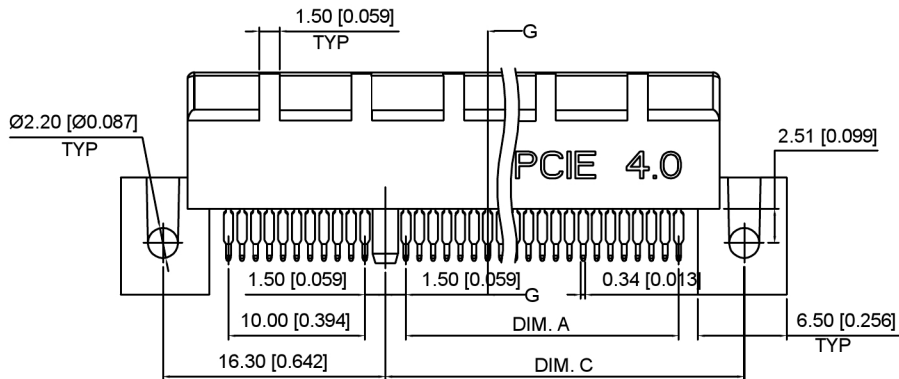
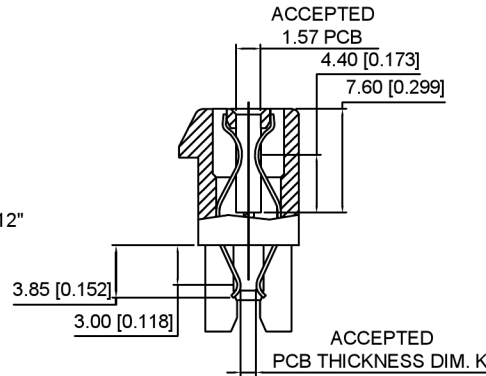
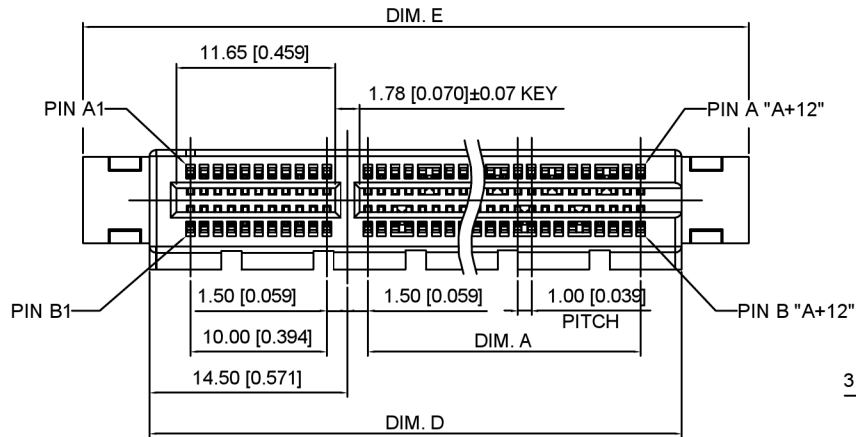

X1619 W S - XX - 9T V15

- ① ② ③ ④ ⑤ ⑥

- ① Series Number
- ② Terminal form: W-Wafer
- ③ Welding Board Angle : Straddle
- ④ No. of Pins: 36~164 Pin
- ⑤ Plastic material: PA9T /PA46 UL94V-0
- ⑥ Contact Plating: V15-Gold 15u"
V30-Gold 30u"

NOTES 备注:

1. MATERIAL 材料:
 - 1.1 HOUSING 胶壳: THERMOPLASTIC, HIGH TEMP, UL94 V-0, COLOR: BLACK.
 - 1.2 CONTACTS 端子: COPPER ALLOY.
 - 1.3 DUMMY CARD 卡: THERMOPLASTIC, HIGH TEMP, UL94 V-0, COLOR: BLACK.
2. FINISH 电镀:
 - CONTACT 端子: SELECTIVE GOLD PLATING ON THE CONTACT AREA. 100µ" MIN. MATTE-TIN PLATING ON THE SOLDER TAILS, 50µ" MIN. NICKEL UNDERPLATING OVERALL.

广东星坤科技股份有限公司

日期

文件工程章

MARK	DESCRIPTION	DATE	REVISED	APPROVED	UNSPECIFIED TOLERANCES
Δ X					ANGULAR ±5°
Δ X					L ≤ 4 ±0.2
Δ X					4 < L ≤ 16 ±0.3
Δ X					16 < L ≤ 63 ±0.4
Δ X					L > 63 ±0.5

DSND	SCALE: N/A	MODEL TYPE:
DWN	VIEW:	PART NO.: X1619WS-XX-9TV15
CHKD	UNIT: mm/in	DWG NO.: X-X1619WS-XX-9TV15
APPD	SIZE: A4	
XKB INDUSTRIAL PRECISION CO., LIMITED		WEIGHT SHEET REVISION 1/1 A0

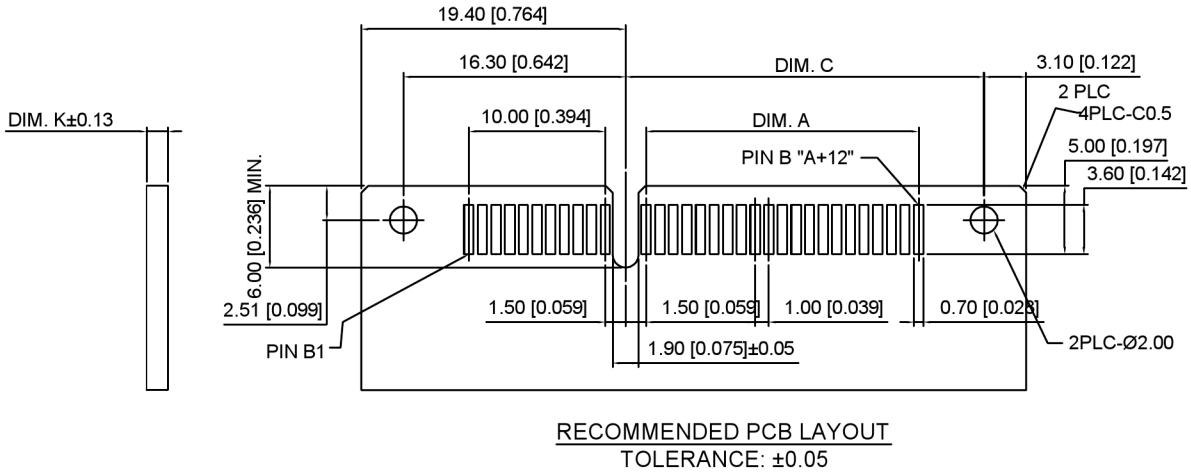
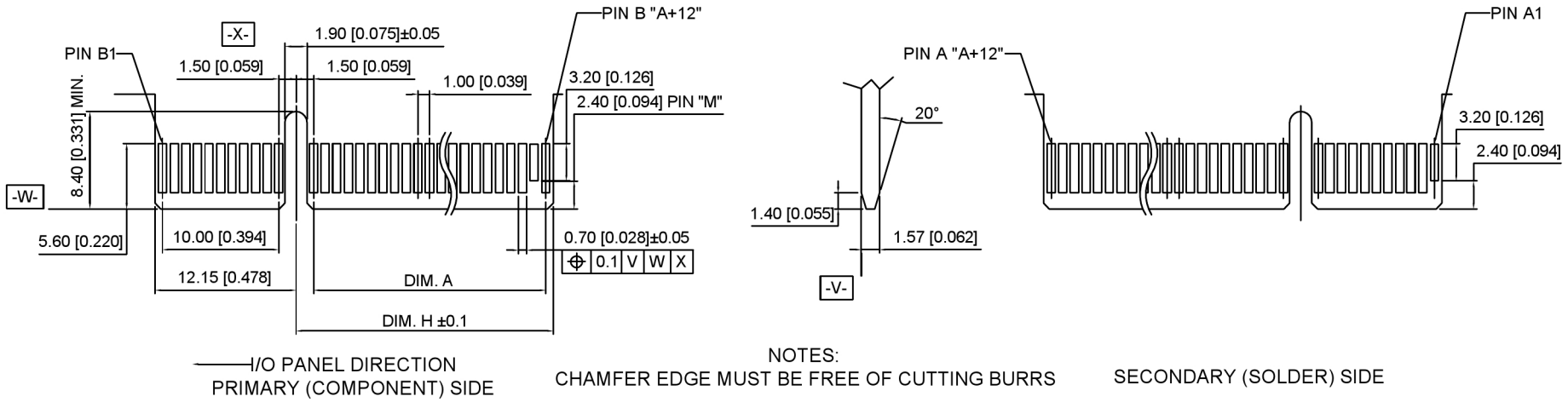

POS.	DIM. A	DIM. C	DIM. H	"M"
36	6	12.3	8.15	B17
64	20	26.3	22.15	B31
98	37	43.3	39.15	B48
164	70	76.3	72.15	B81

广东星坤科技股份有限公司
日期
文件工程章

REVISIONS	DATE	REVISED	APPROVED	UNSPECIFIED TOLERANCES
ANGLAR				±5°
L ≤ 4				±0.2
4 < L ≤ 16				±0.3
16 < L ≤ 63				±0.4
L > 63				±0.5



DSND	SCALE: N/A	MODEL TYPE:
DWN	VIEW:	PART NO.: X1619WS-XX-9TV15
CHKD	UNIT: mm/in	DWG NO.: X-X1619WS-XX-9TV15
APPD	SIZE: A4	
XKB INDUSTRIAL PRECISION CO., LIMITED		WEIGHT
		SHEET
		REVISION
		1/1
		A0

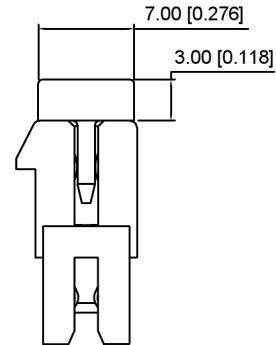
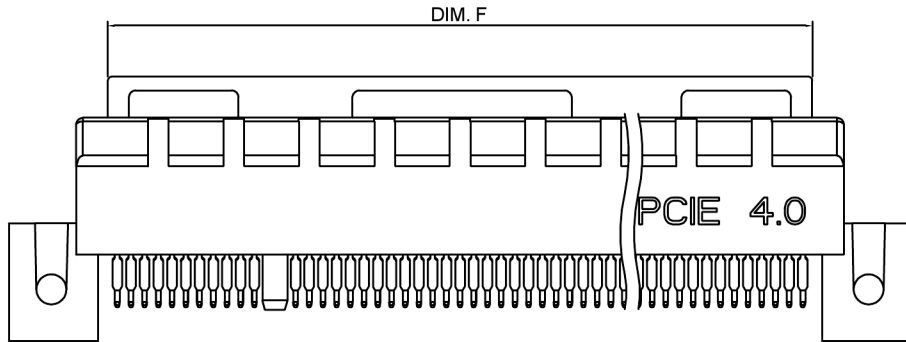
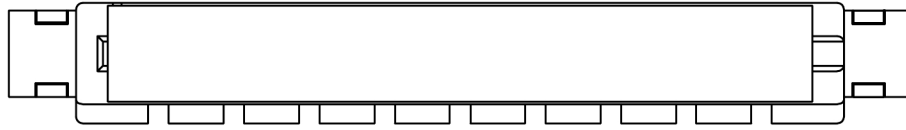

WITH Dummy Card

DIMENSIONS	
POSITION	DIM. F
36	20.4
64	34.4
98	51.4
164	84.4

广东星坤科技股份有限公司

AX		日期
AX		日期
AX		日期
MARK		

文件工程章

REVISIONS	DESCRIPTION	DATE	REVISED	APPROVED	UNSPECIFIED TOLERANCES
					ANGULAR ±5°
					L ≤ 4 ±0.2
					4 < L ≤ 16 ±0.3
					16 < L ≤ 63 ±0.4
					L > 63 ±0.5



DSND		SCALE: N/A
DWN		VIEW:
CHKD		UNIT: mm/in
APPD		SIZE: A4

MODEL TYPE:		
PART NO.: X1619WS-XX-9TV15		
DWG NO.: X-X1619WS-XX-9TV15		
WEIGHT	SHEET	REVISION
	1/1	A0

XKB INDUSTRIAL PRECISION CO., LIMITED

X-ON Electronics

Largest Supplier of Electrical and Electronic Components

Click to view similar products for [XKB](#) manufacturer:

Other Similar products are found below :

[TC-1103-C-B](#) [TC-FS66D-C-A](#) [XKNANO-1307-16](#) [X9396WR-04-N0SN](#) [X9396WR-06-N0SN](#) [X0800WRS-06HF-LPV01](#) [U221-046N-4BU02-FS](#) [X3025WV-02-N0SN](#) [DC-0130-2.5A-2.0](#) [DC-0130-2.5A-2.5](#) [X6511WR-23H-C30D60-R2](#) [DF1-1365UNY-1](#) [XKB5858-Z-F-75](#) [X2011H-05A-N0](#) [X9821H-13A-N0](#) [U263-241N-4BQC13](#) [X6511WVS-12H-C60D48R2](#) [X6511WR-10H-C30D60R2](#) [X1270WVS-2x20A-6TV01](#) [TGG.0B.P04.CLAD52H](#) [ZGG.3K.P12.CLN](#) [ZGG.3K.P12.CLL](#) [ZGG.1K.P02.CLN](#) [ZEG.2K.P02.CLL](#) [ZCG.1B.P16.CLL](#) [TGG.2K.P02.CLAC50](#) [ZEG.3K.P12.CLN](#) [ZEG.2K.P12.CLN](#) [USB31-TYPE-C-FSABC](#) [X0510FVS-168AS-LPV01](#) [MHG.3K.P02.CLLC90H](#) [X6511FRS-05-C85D30](#) [X2001HA-PTAuN-A28B50-X2001HA-PTAuN-IDC](#) [X0709FT7BL1-A28G10-X9555H2-PTV01-IDC](#) [X2513WR-2x06A-LPSN](#) [PJ-3026](#) [TS-1101S-C-B-B-B](#) [SK-3390A-L1](#) [X05A20L17T](#) [TC-1102T-B](#) [X0800WRS-05HF-LPV01](#) [X1502WR-13K-N0SN](#) [U261-2422N-4B0178](#) [SS-3292S-L1-B](#) [X6511WR-04H-C30D60R2](#) [X9821WVS-16-9TSN](#) [X6511WR-03H-C30D60R2](#) [X1311FVS-05-C43D35R2](#) [X1311FR-02-C43D24](#) [X9821H-05A-N0](#)