

DIMENSIONS				
POSITION	A ±0.20	C ±0.25	D ±0.25	E ±0.35
36	6	12.3	25	34.8
64	20	26.3	39	48.8
98	37	43.3	56	65.8
164	70	76.3	89	98.8

PCB Thickness "DIM. K"	DIM.M	
0	2.08	2.55
1	2.30	2.55
2	1.80	2.55
4	1.57	1.70

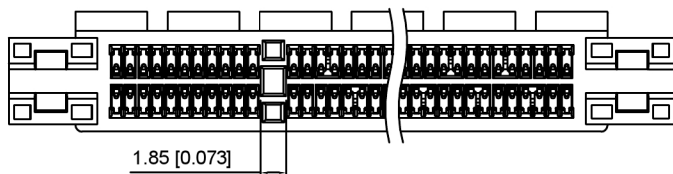
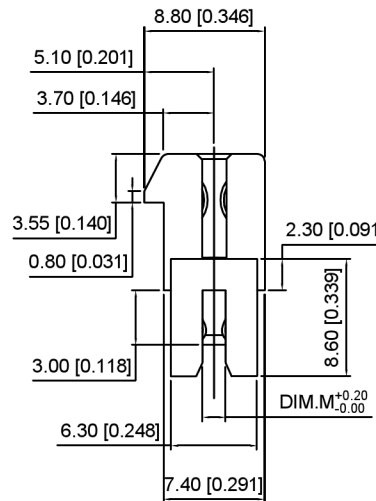
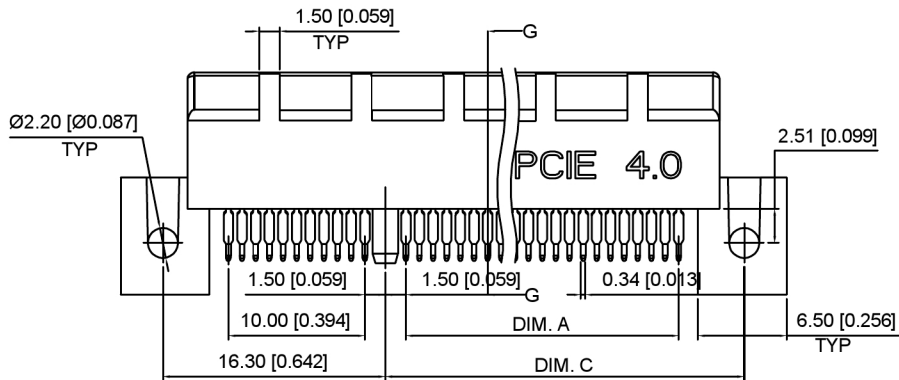
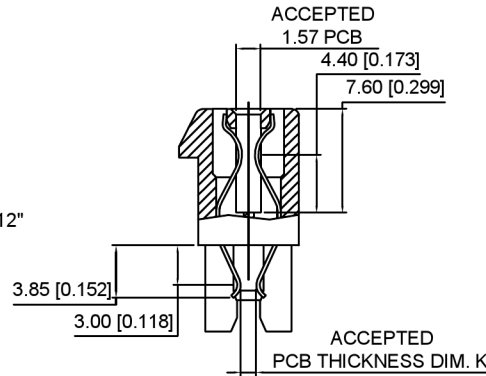
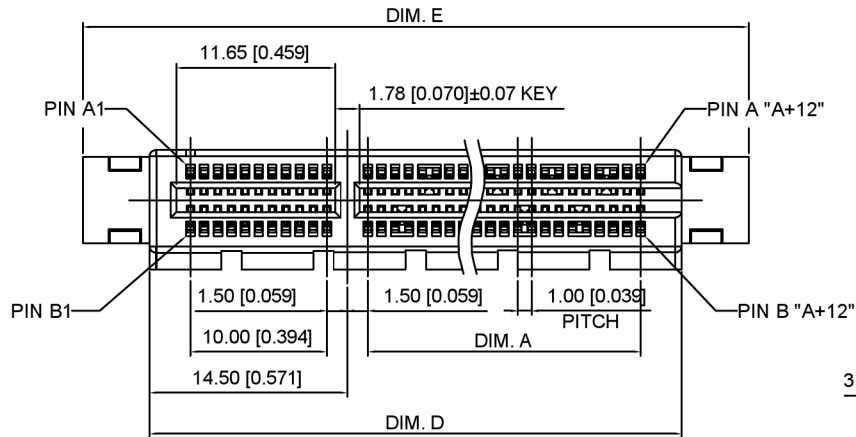

X1619 W S - XX - 9T V15

- ① ② ③ ④ ⑤ ⑥

- ① Series Number
- ② Terminal form: W-Wafer
- ③ Welding Board Angle : Straddle
- ④ No. of Pins: 36~164 Pin
- ⑤ Plastic material: PA9T /PA46 UL94V-0
- ⑥ Contact Plating: V15-Gold 15u"
V30-Gold 30u"

NOTES 备注:

1. MATERIAL 材料:
 - 1.1 HOUSING 胶壳: THERMOPLASTIC, HIGH TEMP, UL94 V-0, COLOR: BLACK.
 - 1.2 CONTACTS 端子: COPPER ALLOY.
 - 1.3 DUMMY CARD 卡: THERMOPLASTIC, HIGH TEMP, UL94 V-0, COLOR: BLACK.
2. FINISH 电镀:
 - CONTACT 端子: SELECTIVE GOLD PLATING ON THE CONTACT AREA. 100µ" MIN. MATTE-TIN PLATING ON THE SOLDER TAILS, 50µ" MIN. NICKEL UNDERPLATING OVERALL.

广东星坤科技股份有限公司

Δ X			
Δ X			
Δ X			
MARK			

文件工程章

REVISIONS	DATE	REVISED	APPROVED	DESCRIPTION

ANGLAR	±5°
L ≤ 4	±0.2
4 < L ≤ 16	±0.3
16 < L ≤ 63	±0.4
L > 63	±0.5
UNSPECIFIED TOLERANCES	



DSND	SCALE: N/A	MODEL TYPE:
DWN	VIEW:	PART NO.: X1619WS-XX-9TV15
CHKD	UNIT: mm/in	DWG NO.: X-X1619WS-XX-9TV15
APPD	SIZE: A4	WEIGHT
XKB INDUSTRIAL PRECISION CO., LIMITED		SHEET 1/1
		REVISION A0

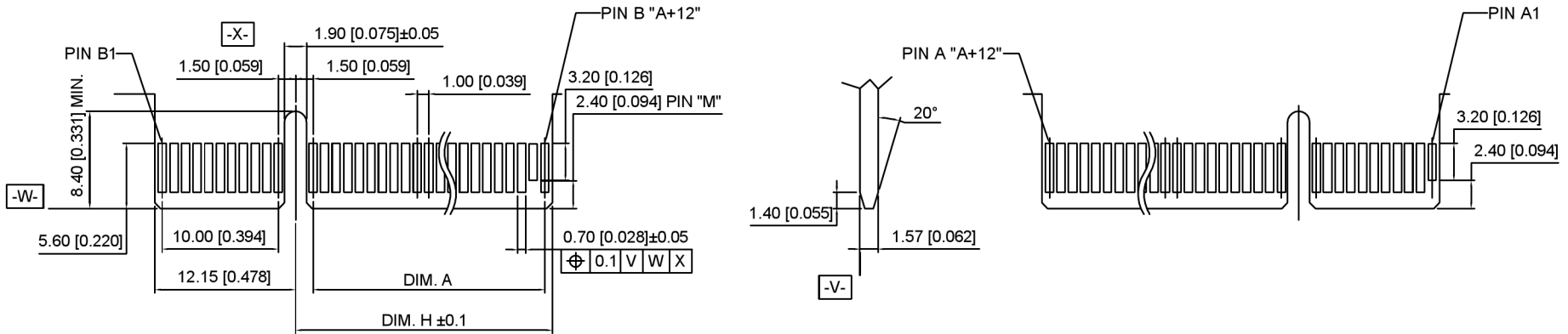

I/O PANEL DIRECTION
PRIMARY (COMPONENT) SIDE CHAMFER EDGE MUST BE FREE OF CUTTING BURRS SECONDARY (SOLDER) SIDE

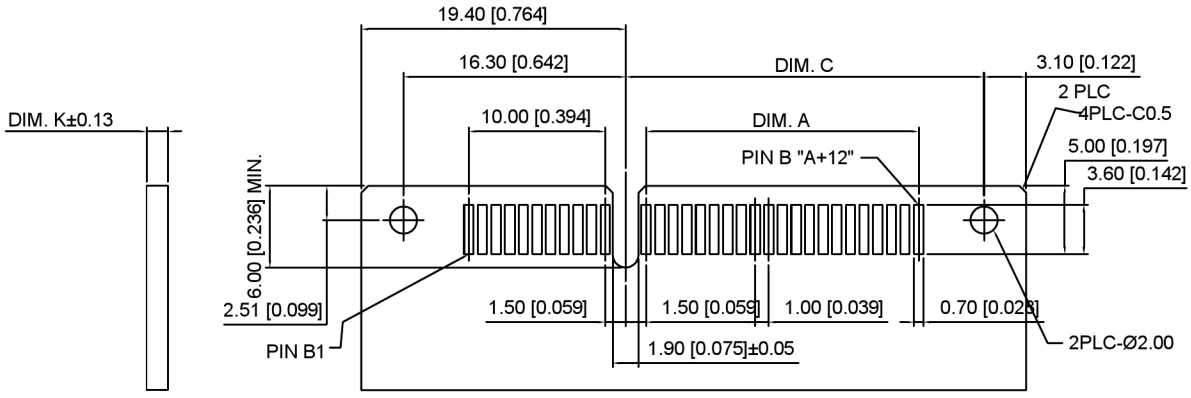

RECOMMENDED PCB LAYOUT
TOLERANCE: ±0.05

POS.	DIM. A	DIM. C	DIM. H	"M"
36	6	12.3	8.15	B17
64	20	26.3	22.15	B31
98	37	43.3	39.15	B48
164	70	76.3	72.15	B81

广东星坤科技股份有限公司

ΔX		日期
ΔX		日期
ΔX		日期
MARK	DESCRIPTION	

文件工程章

REVISIONS	DATE	REVISED	APPROVED	UNSPECIFIED TOLERANCES

www.helloxkb.com www.helloxkb.cn www.xk-dg.cn



XKB INDUSTRIAL PRECISION CO., LIMITED

DSND	SCALE: N/A	MODEL TYPE:
DWN	VIEW:	PART NO.: X1619WS-XX-9TV15
CHKD	UNIT: mm/in	DWG NO.: X-X1619WS-XX-9TV15
APPD	SIZE: A4	
	WEIGHT	SHEET
		REVISION
	1/1	A0

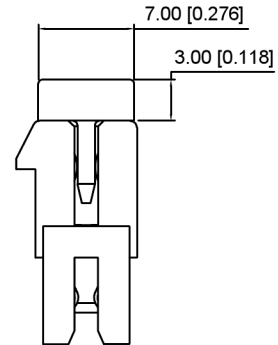
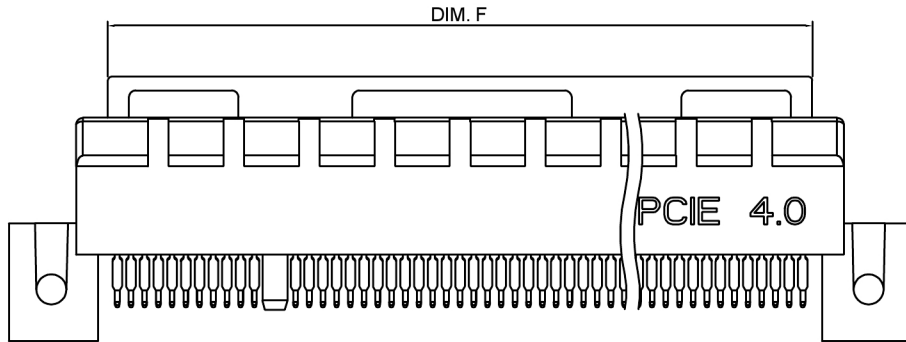
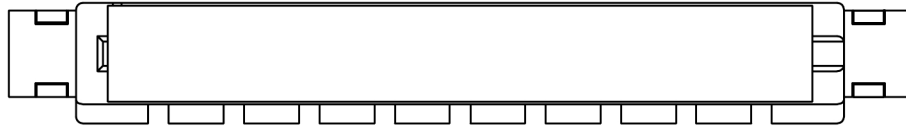

WITH Dummy Card

DIMENSIONS	
POSITION	DIM. F
36	20.4
64	34.4
98	51.4
164	84.4

广东星坤科技股份有限公司

AX		日期
AX		日期
AX		日期
MARK		

文件工程章

REVISIONS	DESCRIPTION	DATE	REVISED	APPROVED	UNSPECIFIED TOLERANCES
					ANGULAR ±5°
					L ≤ 4 ±0.2
					4 < L ≤ 16 ±0.3
					16 < L ≤ 63 ±0.4
					L > 63 ±0.5



DSND		SCALE: N/A
DWN		VIEW:
CHKD		UNIT: mm/in
APPD		SIZE: A4

MODEL TYPE:		
PART NO.: X1619WS-XX-9TV15		
DWG NO.: X-X1619WS-XX-9TV15		
WEIGHT	SHEET	REVISION
	1/1	A0

XKB INDUSTRIAL PRECISION CO., LIMITED

X-ON Electronics

Largest Supplier of Electrical and Electronic Components

Click to view similar products for [XKB](#) manufacturer:

Other Similar products are found below :

[TC-1103-C-B](#) [TC-FS66D-C-A](#) [XKNANO-1307-16](#) [X9396WR-04-N0SN](#) [X9396WR-06-N0SN](#) [X0800WRS-06HF-LPV01](#) [U221-046N-4BU02-FS](#) [X3025WV-02-N0SN](#) [DC-0130-2.5A-2.0](#) [DC-0130-2.5A-2.5](#) [X6511WR-23H-C30D60-R2](#) [DF1-1365UNY-1](#) [XKB5858-Z-F-75](#) [X2011H-05A-N0](#) [X9821H-13A-N0](#) [U263-241N-4BQC13](#) [X6511WVS-12H-C60D48R2](#) [X6511WR-10H-C30D60R2](#) [X1270WVS-2x20A-6TV01](#) [TGG.0B.P04.CLAD52H](#) [ZGG.3K.P12.CLN](#) [ZGG.3K.P12.CLL](#) [ZGG.1K.P02.CLN](#) [ZEG.2K.P02.CLL](#) [ZCG.1B.P16.CLL](#) [TGG.2K.P02.CLAC50](#) [ZEG.3K.P12.CLN](#) [ZEG.2K.P12.CLN](#) [USB31-TYPE-C-FSABC](#) [X0510FVS-168AS-LPV01](#) [MHG.3K.P02.CLLC90H](#) [X6511FRS-05-C85D30](#) [X2001HA-PTAuN-A28B50-X2001HA-PTAuN-IDC](#) [X0709FT7BL1-A28G10-X9555H2-PTV01-IDC](#) [X2513WR-2x06A-LPSN](#) [PJ-3026](#) [TS-1101S-C-B-B-B](#) [SK-3390A-L1](#) [X05A20L17T](#) [TC-1102T-B](#) [X0800WRS-05HF-LPV01](#) [X1502WR-13K-N0SN](#) [U261-2422N-4B0178](#) [SS-3292S-L1-B](#) [X6511WR-04H-C30D60R2](#) [X9821WVS-16-9TSN](#) [X6511WR-03H-C30D60R2](#) [X1311FVS-05-C43D35R2](#) [X1311FR-02-C43D24](#) [X9821H-05A-N0](#)