

Specifications:
 规格:
 Voltage rating:250V AC/DC
 额定电压: 250V AC/DC
 Current rating:4A AC/DC
 额定电流: 4A AC/DC
 Withstanding voltage:1500V AC/minute
 耐受电压: 1500V AC/分钟
 Temperature range:-40°C~+105°C
 温度范围: -40°C~+105°C
 Insulation resistance:1000MΩ min
 绝缘电阻: 1000MΩ Min
 Contact resistance:15mΩ Max
 接触电阻: 15mΩ Max

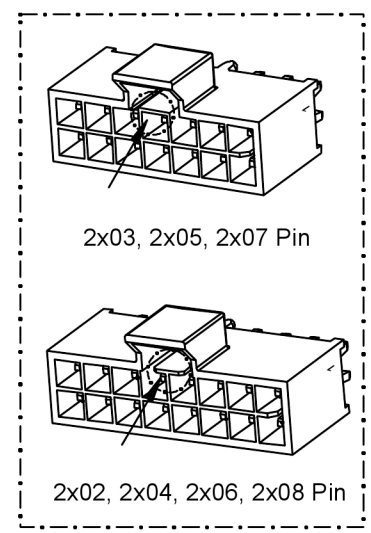
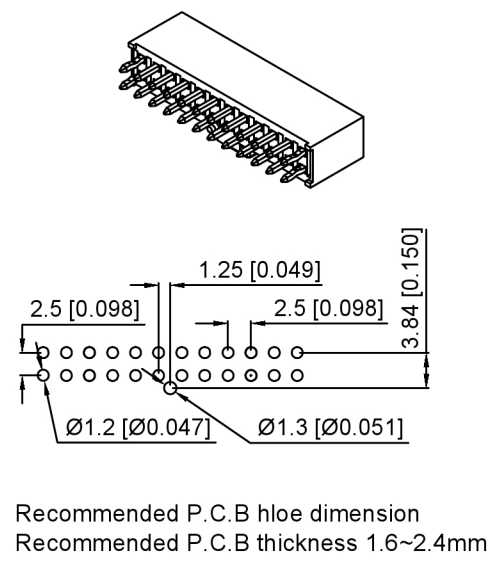
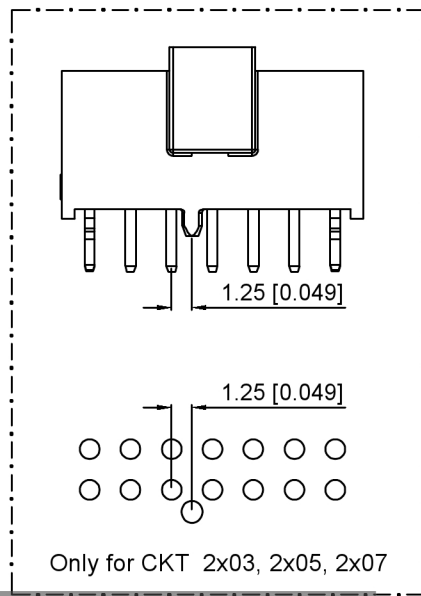

X2513 W V - 2xXX X - LP SN
 ① ② ③ ④ ⑤ ⑥ ⑦

- Series No
- Category:W-Wafer
- Welding Board Range:V-Stright 180°
- Row No.Pin No:2xXX-2x02~2x08 Pin
- Special No: A: A Key(Black); B: B Key (Natural)
- Material:LP-LCP UL94V-0
- Plating:SN-Tin plated

Circuit	DIM. A	DIM. B
N(N=4~16)	1.25 x N - 2.5	1.25 x N + 0.94

X2513WW-2xXXA-LPSN	LCP	Copper Alloy	X2513H
X2513WW-2xXXB-LPSN			
PART NO	Material	Material(Pin)	Suitable XKB Housing

DSND		SCALE: N/A	MODEL TYPE: 2.5mm Crimp Style Connector
DWN		VIEW:	PART NO.: X2513WW-2xXXX-LPSN
CHKD		UNIT: mm/in	DWG NO.: X-X2513WW-2xXXX-LPSN
APPD		SIZE: A4	WEIGHT SHEET REVISION 1/1 A0



XKB INDUSTRIAL PRECISION CO., LIMITED

广东星坤科技股份有限公司

MARK	DESCRIPTION	DATE	REVISED	APPROVED
Δ*				
Δ*				
Δ*				

REVISIONS	DATE	REVISED	APPROVED	UNSPECIFIED TOLERANCES

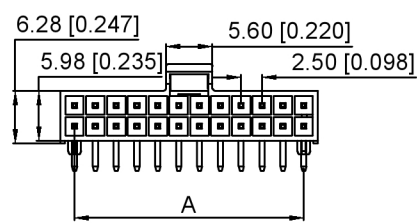
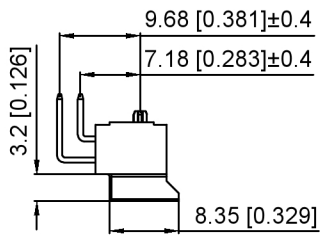
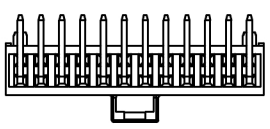
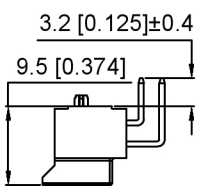
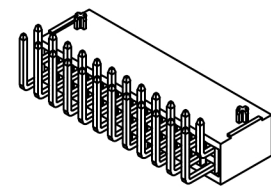
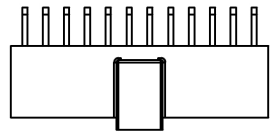
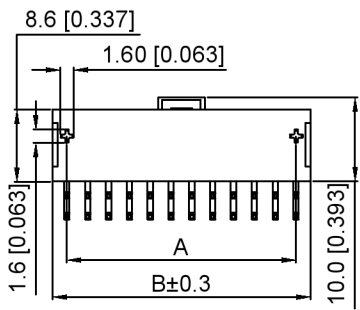

Specifications:

规格:
 Voltage rating:250V AC/DC
 额定电压: 250V AC/DC
 Current rating:5A AC/DC
 额定电流: 5A AC/DC
 Withstanding voltage:1500V AC/minute
 耐受电压: 1500V AC/分钟
 Temperature range:-25℃~+105℃
 温度范围: -25℃~+105℃
 Insulation resistance:1000MΩ min
 绝缘电阻: 1000MΩ Min
 Contact resistance:20mΩ Max
 接触电阻: 20mΩ Max

X2513 W R - 2xXX X - LP SN

① ② ③ ④ ⑤ ⑥ ⑦

- 1.Series No
- 2.Category:W-Wafer
- 3.Welding Board Range:R-Stright 90°
- 4.Row No.Pin No:2xXX-2x02~2x08 Pin
- 5.Special No: A:A Key ; B:B Key
- 6.Material:LP-LCP UL94V-0
- 7.Plating:SN-Tin plated

	2x02	2x03	2x04	2x05
A Key Color:Black				
B Key Color:Natural				
	2x06	2x07	2x08	
A Key Color:Black				
B Key Color:Natural				

A Key

B Key

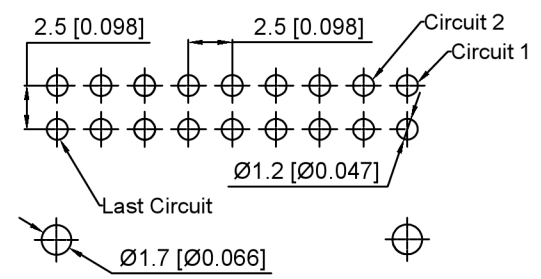

Recommended P.C.B hloe dimension
 Recommended P.C.B thickness 1.6~2.4mm

Circuit	DIM. A	DIM. B
N(N=4~16)	1.25 x N - 2.5	1.25 x N + 0.94

X2513WR-2xXXA-LPSN	LCP	Copper Alloy	X2513H
X2513WR-2xXXB-LPSN			
PART NO	Material	Material(Pin)	Suitable XKB Housing

广东星坤科技股份有限公司

Δ姓	日期
Δ数	
ΔX	

文件工程章

MARK	DESCRIPTION	DATE	REVISED	APPROVED	ANGLAR	±5°
					L ≤ 4	±0.2
					4 < L ≤ 16	±0.3
					16 < L ≤ 63	±0.4
					L > 63	±0.5
					UNSPECIFIED TOLERANCES	



DSND	SCALE: N/A	MODEL TYPE: 2.5mm Crimp Style Connector
DWN	VIEW:	PART NO.: X2513WR-2xXXX-LPSN
CHKD	UNIT: mm/in	DWG NO.:
APPD	SIZE: A4	X-X2513WR-2xXXX-LPSN
KKB INDUSTRIAL PRECISION CO.,LIMITED		WEIGHT
		SHEET
		REVISION
		1/1
		A0

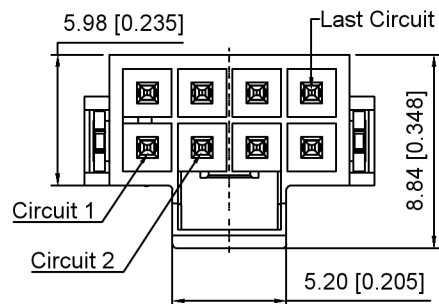
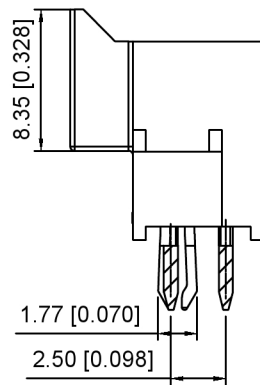
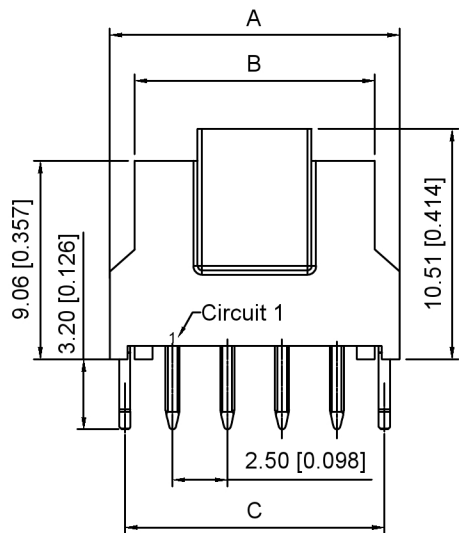

Specifications:
 规格:
Voltage rating:250V AC/DC
 额定电压: 250V AC/DC
Current rating:4A AC/DC
 额定电流: 4A AC/DC
Withstanding voltage:1500V AC/minute
 耐受电压: 1500V AC/分钟
Temperature range:-40°C~+105°C
 温度范围: -40°C~+105°C
Insulation resistance:1000MΩ min
 绝缘电阻: 1000MΩ Min
Contact resistance:15mΩ Max
 接触电阻: 15mΩ Max

X2513 W V - 2xXX L X - LP SN
 ① ② ③ ④ ⑤ ⑥ ⑦ ⑧

	2x02 Pin	2x03 Pin	2x04 Pin	2x05 Pin
A Key BLACK				
B Key NATURAL				
	2x06 Pin	2x07 Pin	2x08 Pin	
A Key BLACK				
B Key NATURAL				

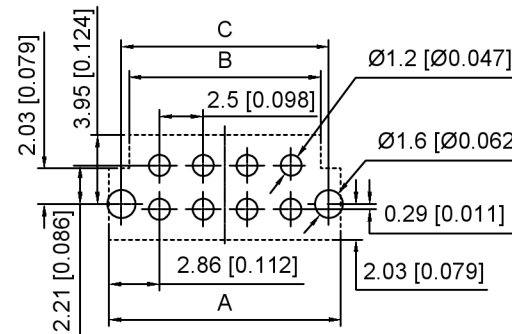

Recommended PCB Layout(Connector SIDE VIEW)
 Thickness=1.6mm ~2.4mm Tolerance:±0.05

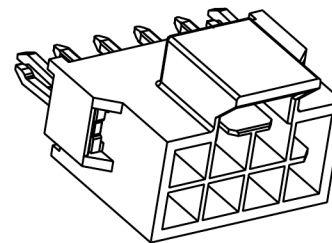

- Series No
- Category:W-Wafer
- Welding Board Range:V-Stright 180°
- Row No.Pin No:2xXX-2x02~2x12 Pin
- Special No:L-There are fixed card slots on both sides
- Type: A-A Key only for Black
B-B Key only for Natural color
- Material:LP-LCP UL94V-0
- Plating:SN-Tin plated
V01-Gold Flash

PART NO	DIM.A	DIM.B	DIM.C
2x02	8.22	5.95	6.84
2x03	10.72	8.44	9.34
2x04	13.22	10.94	11.84
2x05	15.72	13.44	14.34
2x06	18.22	15.94	16.84
2x07	20.72	18.44	19.34
2x08	23.22	20.94	21.84
2x12	25.22	22.94	23.84

X2513WV-2xXXLA-LPSN	LCP	Copper Alloy	X2513H
X2513WV-2xXXLB-LPSN			
PART NO	Material	Material(Pin)	Suitable XKB Housing

DSND		SCALE: N/A	MODEL TYPE: 2.5mm Crimp Style Connector
DWN		VIEW:	PART NO.: X2513WV-2xXXLX-LPSN
CHKD		UNIT: mm/in	DWG NO.: X-X2513WV-2xXXLX-LPSN
APPD		SIZE: A4	WEIGHT SHEET REVISION 1/1 A0



XKB INDUSTRIAL PRECISION CO.,LIMITED

ANGLAR	±5°
L ≤ 4	±0.2
4 < L ≤ 16	±0.3
16 < L ≤ 63	±0.4
L > 63	±0.5
UNSPECIFIED TOLERANCES	

广东星坤科技股份有限公司

姓名	日期
数量	日期

文件工程章

MARK	DESCRIPTION	DATE	REVISED	APPROVED
	REVISIONS			

www.helloxkb.com www.helloxkb.cn www.xk-dg.cn

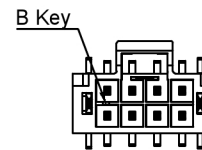
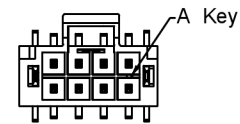
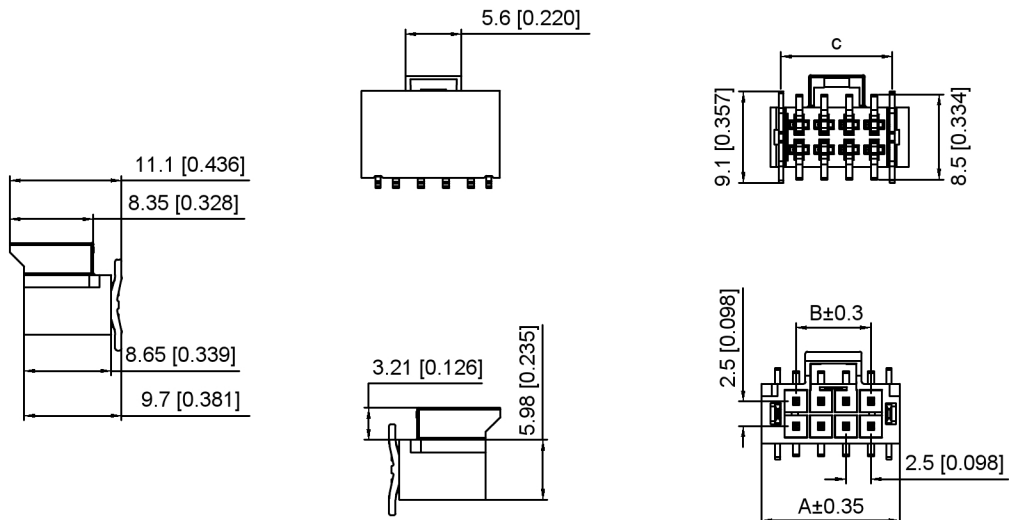

Specifications:
 规格:
 Voltage rating:250V AC/DC
 额定电压: 250V AC/DC
 Current rating:4A AC/DC
 额定电流: 4A AC/DC
 Withstanding voltage:1500V AC/minute
 耐受电压: 1500V AC/分钟
 Temperature range:-40℃~+105℃
 温度范围: -40℃~+105℃
 Insulation resistance:1000MΩ min
 绝缘电阻: 1000MΩ Min
 Contact resistance:15mΩ Max
 接触电阻: 15mΩ Max

X2513 W V S - 2xXX L X - LP SN
 ① ② ③ ④ ⑤ ⑥ ⑦ ⑧ ⑨

- Series No
- Category:W-Wafer
- Welding Board Range:V-Stright 180°
- Welding Way:S-SMT
- Row No.Pin No:2xXX-2x02~2x12 Pin
- Special No:L-There are fixed card slots on both sides
- Type: A-A Key only for Black
B-B Key only for Natural ccolor
- Material:LP-LCP UL94V-0
- Plating:SN-Tin plated
V01-Gold Flash

	2x02 Pin	2x03 Pin	2x04 Pin	2x05 Pin
A Key BLACK				
B Key NATURAL				
	2x06 Pin	2x07 Pin	2x08 Pin	
A Key BLACK				
B Key NATURAL				

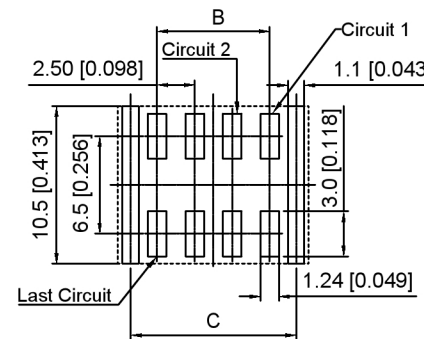

Recommended PCB Layout(Connector SIDE VIEW)
 Thickness=1.6mm Min.Tolerance:±0.05

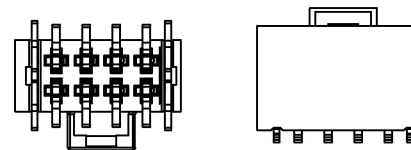

PART NO	DIM.A	DIM.B	DIM.C
2x02	8.83	2.50	6.11
2x03	11.33	5.00	8.61
2x04	13.83	7.50	11.11
2x05	16.33	10.00	13.61
2x06	18.83	12.50	16.11
2x07	21.33	15.00	18.61
2x08	23.83	17.50	21.11
2x12	25.83	19.50	23.11

X2513WVS-2xXXLA-LPSN	LCP	Copper Alloy	X2513H
X2513WVS-2xXXLB-LPSN			
PART NO	Material	Material(Pin)	Suitable XKB Housing

DSND		SCALE: N/A	MODEL TYPE: 2.5mm Crimp Style Connector
DWN		VIEW:	PART NO.: X2513WVS-2xXXLX-LPSN
CHKD		UNIT: mm/in	DWG NO.:
APPD		SIZE: A4	X-X2513WVS-2xXXLX-LPSN

XKLB

XKB INDUSTRIAL PRECISION CO., LIMITED

WEIGHT	SHEET	REVISION
	1/1	A0

广东星坤科技股份有限公司

DATE	日期
MARK	文件工程章

REVISIONS	UNSPECIFIED TOLERANCES
DATE	APPROVED
REVISED	APPROVED

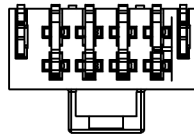
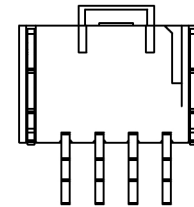
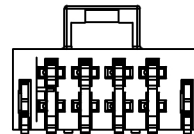
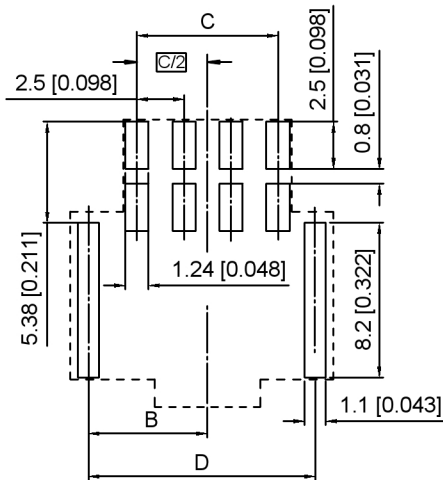
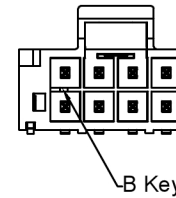
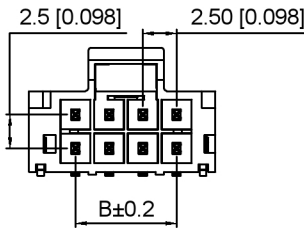
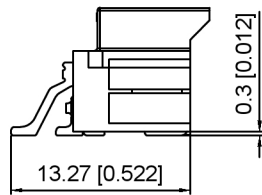
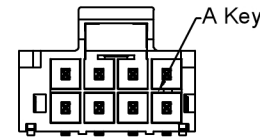
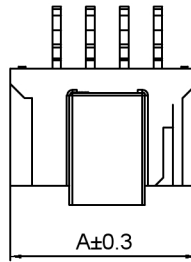
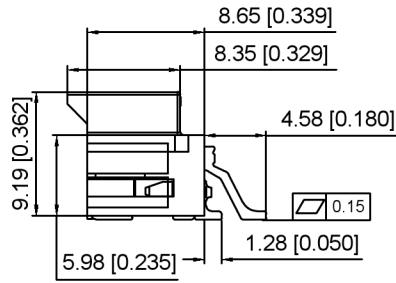

Specifications:
 规格:
 Voltage rating:250V AC/DC
 额定电压: 250V AC/DC
 Current rating:4A AC/DC
 额定电流: 4A AC/DC
 Withstanding voltage:1500V AC/minute
 耐受电压: 1500V AC/分钟
 Temperature range:-40℃~+105℃
 温度范围: -40℃~+105℃
 Insulation resistance:1000MΩ min
 绝缘电阻: 1000MΩ Min
 Contact resistance:15mΩ Max
 接触电阻: 15mΩ Max

X2513	W	R	S	- 2xXX	L	X	LP	SN
①	②	③	④	⑤	⑥	⑦	⑧	⑨

- 1.Series No
- 2.Category:W-Wafer
- 3.Welding Board Range:R-Stright 90°
- 4.Welding Way:S-SMT
- 5.Row No.Pin No:2xXX-2x02~2x08 Pin
- 6.Special No:L-There are fixed card slots on both sides
- 7.Type: A-A Key only for Black
B-B Key only for Natural ccolor
- 8.Material:LP-LCP UL94V-0
- 9.Plating:SN-Tin plated
V01-Gold Flash

PART NO	DIM.A	DIM.B	DIM.C	DIM.D
2x02	8.74	3.82	2.50	7.04
2x03	11.24	5.07	5.00	9.54
2x04	13.74	6.32	7.50	12.04
2x05	16.24	7.57	10.00	14.54
2x06	18.74	8.82	12.50	17.04
2x07	21.24	10.07	15.00	19.54
2x08	23.74	11.32	17.50	22.04

Recommended PCB Layout(Connector SIDE VIEW)
 Thickness=1.6mm Min.Tolerance:±0.05

X2513WRS-2xXXLA-LPSN	LCP	Copper Alloy	X2513H
X2513WRS-2xXXLB-LPSN			
PART NO	Material	Material(Pin)	Suitable XKB Housing

DSND		SCALE: N/A	MODEL TYPE: 2.5mm Crimp Style Connector
DWN		VIEW:	PART NO.: X2513WRS-2xXXLX-LPSN
CHKD		UNIT: mm/in	DWG NO.:
APPD		SIZE: A4	X-X2513WRS-2xXXLX-LPSN



XKLB INDUSTRIAL PRECISION CO., LIMITED

WEIGHT	SHEET	REVISION
	1/1	A0

ANGULAR	±5°
L ≤ 4	±0.2
4 < L ≤ 16	±0.3
16 < L ≤ 63	±0.4
L > 63	±0.5

UNSPECIFIED TOLERANCES

广东星坤科技股份有限公司

DATE	日期
DESCRIPTION	文件工程章

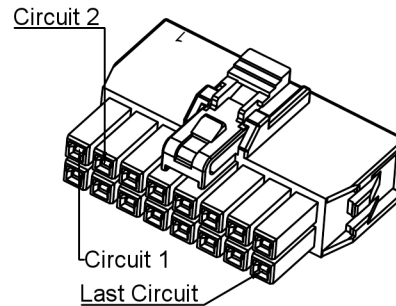
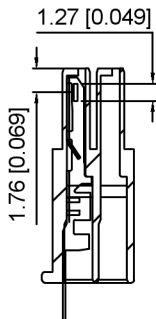
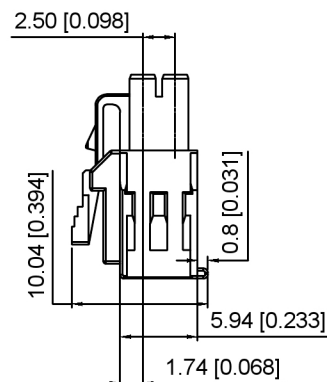
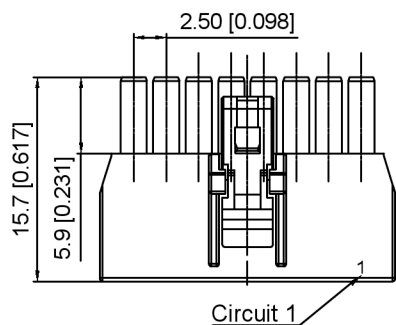

Specifications:

规格:
 Voltage rating: 250V AC/DC
 额定电压: 250V AC/DC
 Current rating: 4A AC/DC
 额定电流: 4A AC/DC
 Withstanding voltage: 1500V AC/minute
 耐受电压: 1500V AC/分钟
 Temperature range: -40°C~+105°C
 温度范围: -40°C~+105°C
 Insulation resistance: 1000MΩ min
 绝缘电阻: 1000MΩ Min
 Contact resistance: 30mΩ Max
 接触电阻: 30mΩ Max

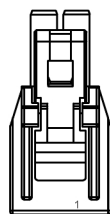
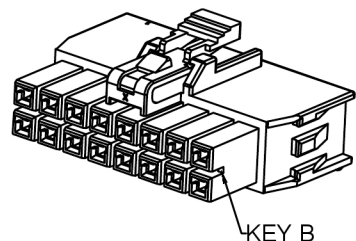
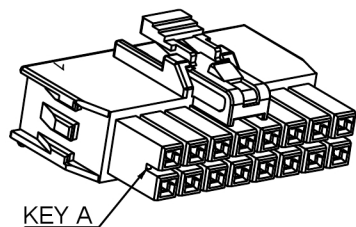
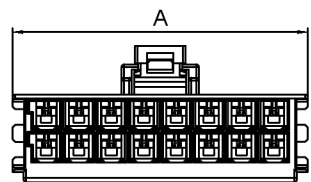

2x02 Pin

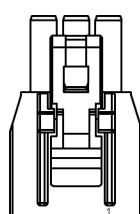

2x03 Pin

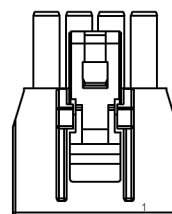

2x04 Pin

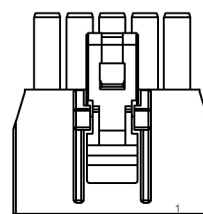

2x05 Pin

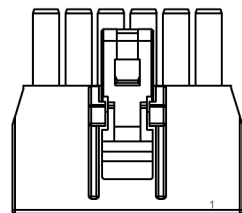

2x06 Pin

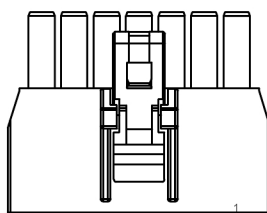

2x07 Pin

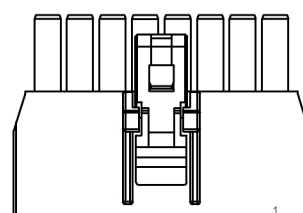

2x08 Pin

X2513 H - 2xXX X - 46
 ① ② ③ ④ ⑤

1. Series No
2. Category: H-HSG
3. Row No. Pin No: 2xXX-2x02~2x12 Pin
4. Special No: A: Key A (Black)
B: Key B (Natural)
5. Material: 46-Nylon 46+30%G.F UL94V-0

Poles	Dimensions(mm)
	A
2x02	7.70
2x03	10.20
2x04	12.70
2x05	15.20
2x06	17.70
2x07	20.20
2x08	22.70
2x12	32.70

X2513H-2xXXX-46	Nylon 46+30%G.F	X2513W	X2513T
X2513H-2xXXB-46			
PART NO	Material	Suitable XKB Wafer	Suitable XKB Terminal

DSND		SCALE: N/A	MODEL TYPE: 2.5mm Crimp Style Connector
DWN		VIEW:	PART NO.: X2513H-2xXXX-46
CHKD		UNIT: mm/in	DWG NO.: X-X2513H-2xXXX-46
APPD		SIZE: A4	



XKB INDUSTRIAL PRECISION CO., LIMITED

WEIGHT	SHEET	REVISION
	1/1	A0

广东星坤科技股份有限公司

Δ建	日期
Δ改	日期
ΔX	

文件工程章

MARK	DESCRIPTION	DATE	REVISED	APPROVED	ANGLAR	±5°
					L ≤ 4	±0.2
					4 < L ≤ 16	±0.3
					16 < L ≤ 63	±0.4
					L > 63	±0.5

REVISIONS
 www.helloxkb.com www.helloxkb.cn www.xk-dg.cn

UNSPECIFIED TOLERANCES

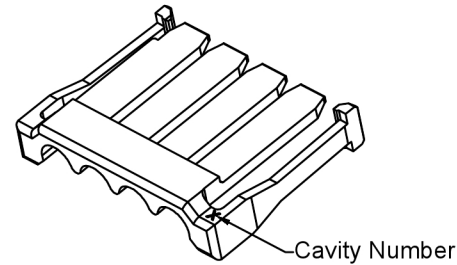
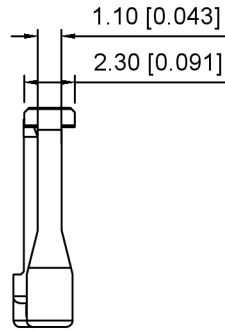
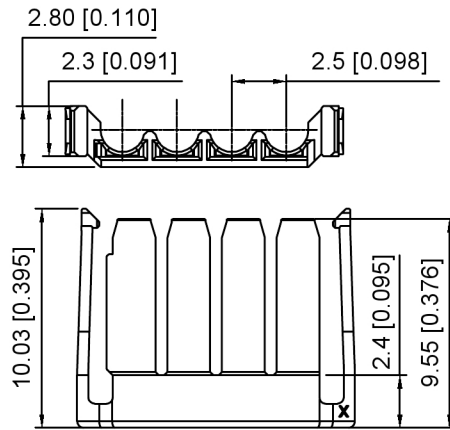

Specifications:
 规格:
 Voltage rating: 250V AC/DC
 额定电压: 250V AC/DC
 Current rating: 3A AC/DC
 额定电流: 3A AC/DC
 Withstanding voltage: 1500V AC/minute
 耐受电压: 1500V AC/分钟
 Temperature range: -40°C +105°C
 温度范围: -40°C +105°C
 Insulation resistance: 1000MΩ min
 绝缘电阻: 1000MΩ Min
 Contact resistance: 30mΩ Max
 接触电阻: 30mΩ Max

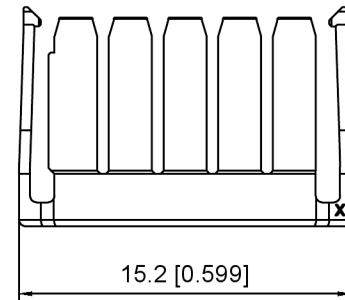
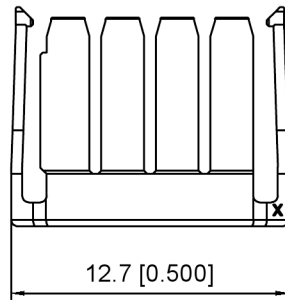
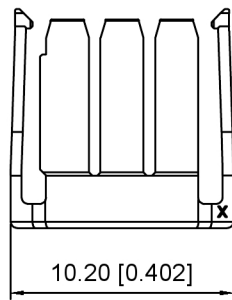
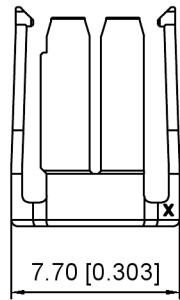

X2513 H L - XX - N0 X
 ① ② ③ ④ ⑤ ⑥

1. Series No
2. Category: H-HSG
3. Category: L-jointing clamp
4. Row No. Pin No: XX-02~08 Pin
5. Material: N0-Nylon 66 UL94V-0
6. Color: Blank-Natural ; BK-Black

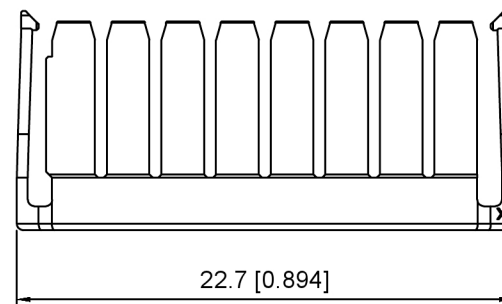
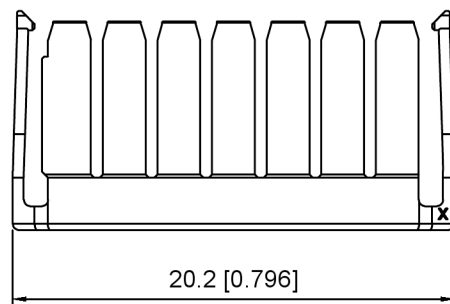
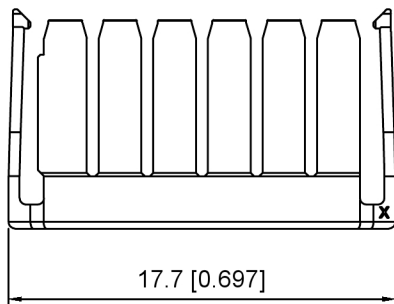

X2513HL-XX-N0	Nylon 66	X2513H	X2513T
PART NO	Material	Suitable XKB Housing	Suitable XKB Terminal

广东星坤科技股份有限公司

文件工程章

ANGLAR	±5°
L ≤ 4	±0.2
4 < L ≤ 16	±0.3
16 < L ≤ 63	±0.4
L > 63	±0.5
UNSPECIFIED TOLERANCES	



DSND	SCALE: N/A	MODEL TYPE: 2.5mm Crimp Style Connector
DWN	VIEW:	PART NO.: X2513HL-XX-N0
CHKD	UNIT: mm/in	DWG NO.: X-X2513HL-XX-N0
APPD	SIZE: A4	WEIGHT SHEET REVISION 1/1 A0

XKB INDUSTRIAL PRECISION CO., LIMITED

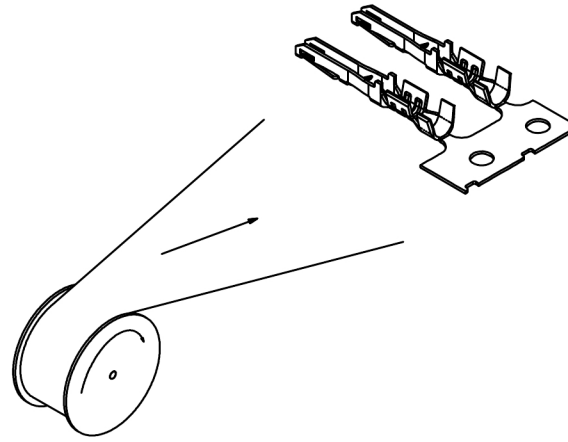
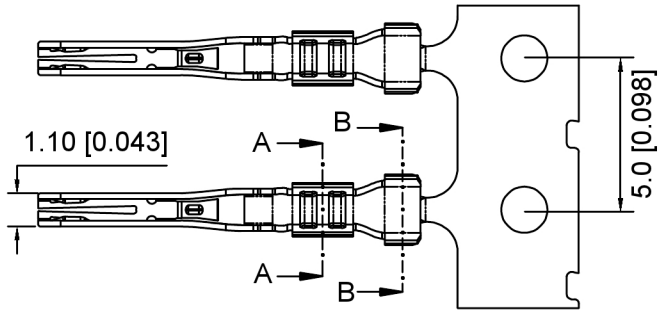

Specifications:
 规格:
 Voltage rating:250V AC/DC
 额定电压: 250V AC/DC
 Current rating:4A AC/DC
 额定电流: 4A AC/DC
 Withstanding voltage:1500V AC/minute
 耐受电压: 1500V AC/分钟
 Temperature range:-40°C-+105°C
 温度范围: -40°C-+105°C
 Insulation resistance:1000MΩ min
 绝缘电阻: 1000MΩ Min
 Contact resistance:30mΩ Max
 接触电阻: 30mΩ Max

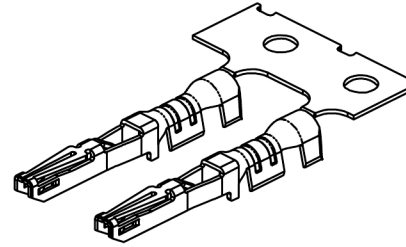
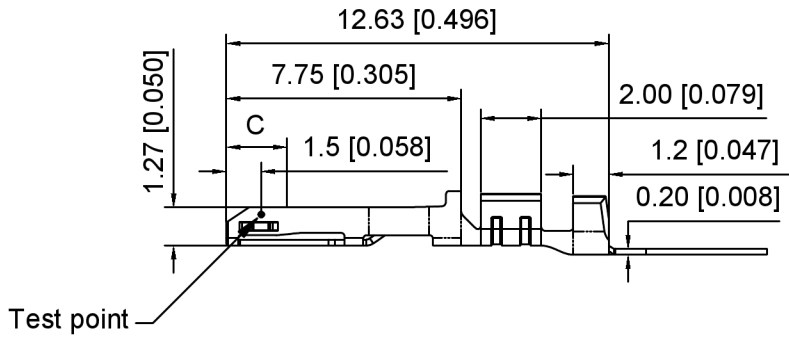

X2513 T - P V01 - X
 ① ② ③ ④ ⑤

1. Series No
2. Category:T-Terminal
3. Material :P-Phosphor Bronze
H-High Conductivity Copper Alloy
4. Plating:V01-Gold Flash
5. Special N0:H-High foot For #20~22AWG
L-Low foot For #24~26AWG

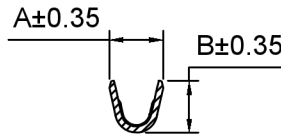

SEC:A-A

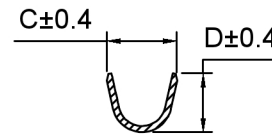

SEC:B-B

X2513T-PSN-H	AWG#20~22	1.80	1.85	2.33	1.94
X2513T-PSN-L	AWG#24~26	1.39	1.45	2.12	2.00
PART NO	Wire Range	DIM.A	DIM.B	DIM.C	DIM.D

X2513T-PSN-X	Phosphor Bronze	X2513H	X2513W
PART NO	Material	Suitable XKB Housing	Suitable XKB Wafer

DSND		SCALE: N/A	MODEL TYPE: 2.5mm Crimp Style Connector
DWN		VIEW:	PART NO.: X2513T-PSN-X
CHKD		UNIT: mm/in	DWG NO.: X-X2513T-PSN-X
APPD		SIZE: A4	

XKLB

XKB INDUSTRIAL PRECISION CO., LIMITED

WEIGHT	SHEET	REVISION
	1/1	A0

广东星坤科技股份有限公司

Δ建	日期
Δ改	
Δ修	
Δ查	

MARK DESCRIPTION DATE REVISED APPROVED

REVISIONS

UNSPECIFIED TOLERANCES

www.helloxkb.com www.helloxkb.cn www.xk-dg.cn

文件工程章

X-ON Electronics

Largest Supplier of Electrical and Electronic Components

Click to view similar products for [Headers & Wire Housings](#) category:

Click to view products by [XKB](#) manufacturer:

Other Similar products are found below :

[57102-F02-18ULF](#) [58102-G61-06LF](#) [582553-1](#) [009176003701906](#) [01.001.5753.1](#) [0050291907](#) [02.125.8002.8](#) [609-3404](#) [61062-3](#)
[CSU011177004](#) [622-0430](#) [622-3653LF](#) [63453-116](#) [636-1030](#) [636-1427](#) [636-3427](#) [636-4007](#) [641938-9](#) [644827-2](#) [65495-038](#) [65692-001LF](#)
[65781-018](#) [65781-047](#) [65817-010LF](#) [65817-015LF](#) [66207-023LF](#) [67095-007LF](#) [67601157](#) [68631-112](#) [68645-018](#) [699319-000](#)
[M90C108951C](#) [70.362.1628.0](#) [70-4210](#) [70-4226B](#) [70-4853B](#) [707-5028](#) [71.350.2428.0](#) [71961-016LF](#) [733-134](#) [733-162](#) [754199-000](#) [760-](#)
[3052](#) [80.063.4001.1](#) [800-90-001-10-001000](#) [800-90-010-10-002000](#) [801-43-002-10-013000](#) [801-43-006-10-002000](#) [803-41-018-10-001000](#)
[803-43-024-10-001000](#)