

For and on behalf of
XKB INDUSTRIAL PRECISION CO., LIMITED
 香港星坤工業精密有限公司

REVISIONS
 Authorized Signature(s)

MARK	DESCRIPTION	DATE	REVISED	APPROVED	UNSPECIFIED TOLERANCES
△ X					L > 63 ±0.5
△ X					16 < L ≤ 63 ±0.4
△ X					4 < L ≤ 16 ±0.3
					L ≤ 4 ±0.2
					ANGULAR ±5°

DATE	DATE	DATE	DATE	DATE	DATE
DATE	DATE	DATE	DATE	DATE	DATE
SCALE: N/A	VIEW:	UNIT: mm	SIZE: A4		

WEIGHT	SHEET	REVISION
1.0g	1/1	A0

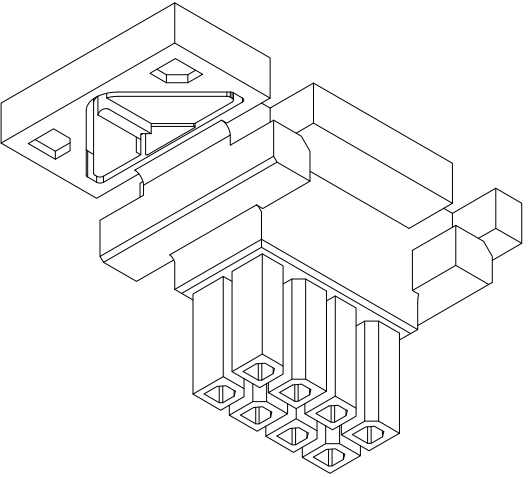
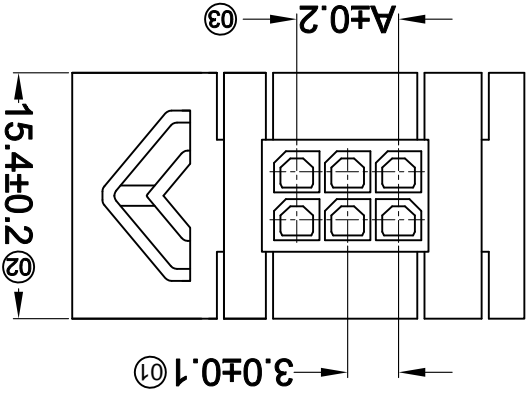
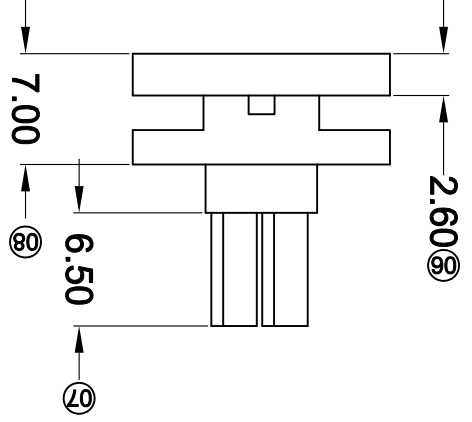
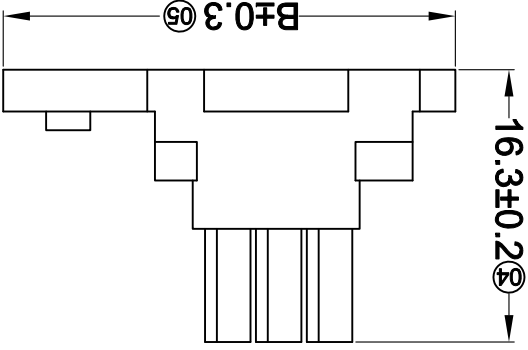

Poles	Dimensions(mm)		Poles	Dimensions(mm)	
	A	B		A	B
2*02	3.00	24.85	2*08	21.00	42.85
2*03	6.00	27.85	2*09	24.00	45.85
2*04	9.00	30.85	2*10	27.00	48.85
2*05	12.00	33.85	2*11	30.00	51.85
2*06	15.00	36.85	2*12	33.00	54.85
2*07	18.00	39.85			

- ① Series No.
- ② Category: H-HSG
- ③ Welding Board Angle: F-Female HSG
- ④ Row No.-Pin No.: 2*XX-2*02P~2*12P
- ⑤ Plug the Pin & special No.: WS-With Base
- ⑥ Material: N2-PA66 94V-2;
- ⑦ Color: Blank-natural color

X3025 H F-2*XX WS-N2 XX
 ① ② ③ ④ ⑤ ⑥ ⑦

- Specifications :
- Voltage rating: 250V AC / DC
 - Current rating: 5A AC / DC
 - Withstanding voltage: 1500V AC/minute
 - Temperature range: -25°C~+85°C
 - Insulation resistance: ≥1000MΩ
 - Contact resistance: ≤10mΩ
 - After environmental testing: ≤17mΩ

RoHS
Lead-free

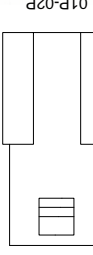
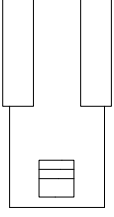
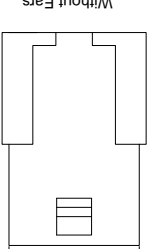
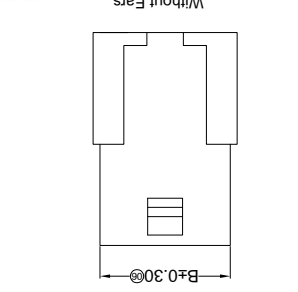
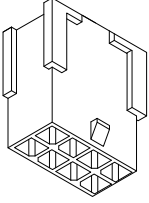
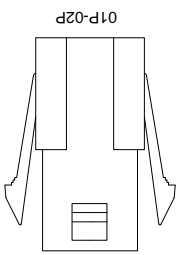
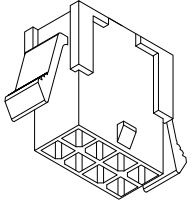
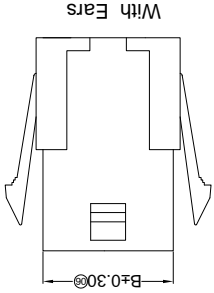
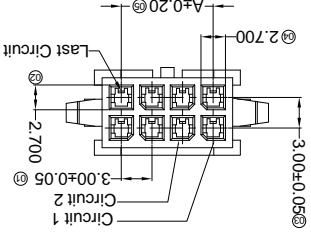

For and on behalf of
XKB INDUSTRIAL PRECISION CO., LIMITED
香港星坤工業精密有限公司

MARK	DESCRIPTION	DATE	REVISED	APPROVED	UNSPECIFIED TOLERANCES
△ X					$L > 63$
△ X					$16 < L \leq 63$
△ X					$4 < L \leq 16$
					$L \leq 4$
					ANGULAR $\pm 5^\circ$

REVISIONS
(Unauthorized Signature(s))

DSND	DATE	SCALE: N/A	MODEL TYPE: X3025HF-2*XX-N2
DWN	DATE	VIEW:	PART NO.: 3.00 mm Crimp Style Connectors
CHKD	DATE	UNIT: mm	DWG NO.:
APPD	DATE	SIZE: A4	

XKB INDUSTRIAL PRECISION CO., LIMITED

WEIGHT	SHEET	REVISION
1.0g	1/1	A0

PART NO	Material	Suitable SWB Terminal	Mates With XKB Housing	Note
X3025HF-2*XXG-N2	Nylon 66 94V-2	X3025TM	X3025HM	With Ears
X3025HF-2*XXI-N2	Nylon 66 94V-2	X3025TM	X3025HM	Without Ears

Poles	Dimensions(mm)		Poles	Dimensions(mm)	
	A	B		A	B
2*01	18.00	22.00	2*07	4.00	2.07
2*02	3.00	7.00	2*08	7.00	2.08
2*03	6.00	10.00	2*09	10.00	2.09
2*04	9.00	13.00	2*10	13.00	2.10
2*05	12.00	16.00	2*11	16.00	2.11
2*06	15.00	19.00	2*12	19.00	2.12
			A		33.00
			B		37.00

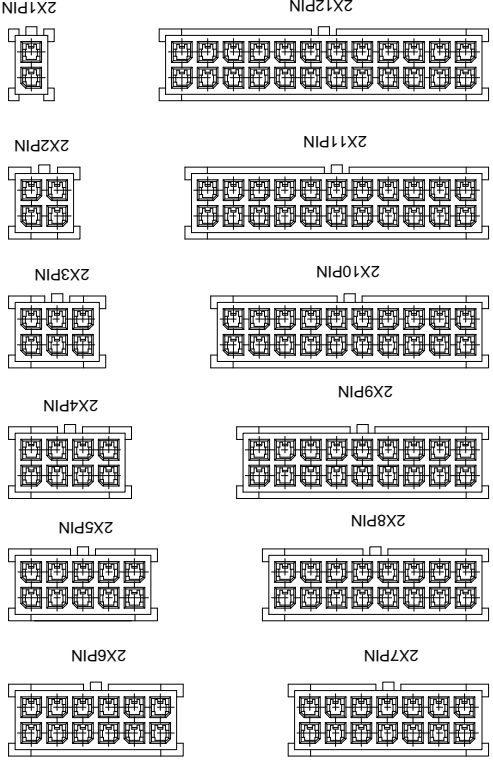

- Specifications :**
- Voltage rating: 250V AC / DC
 - Current rating: 5A AC / DC
 - Withstanding voltage: 1000V AC/minute
 - Temperature range: -25°C~+85°C
 - Insulation resistance: $\geq 1000M\Omega$
 - Contact resistance: $\leq 10m\Omega$
 - After environmental testing: $\leq 20m\Omega$
- ①** Series No.
② Category: H-HSG
③ Welding Board Angle: F-Female HSG
④ Row No.-Pin No.: 2*XX-2*01P-2*12P
⑤ Plug the Pin & special No.: I-Without Ears
⑥ Material: N2-PA66 94V-2;
⑦ Color: Blank-Natural Color

X3025 H F-2*XX XX-N2 XX

① ② ③ ④ ⑤ ⑥ ⑦

8

7

6

5

4

3

2

1

E

F

D

F

C

F

B

F

A

F

For and on behalf of
KRB INDUSTRIAL PRECISION CO., LIMITED
 香港星坤工業精密有限公司

MARK	DESCRIPTION	DATE	REVISIONS	UNSPECIFIED TOLERANCES
△ X				L > 63 ±0.5
△ X				16 > L ≤ 63 ±0.4
△ X				4 < L ≤ 16 ±0.3
				L ≤ 4 ±0.2
				ANGULAR ±5°

REVISIONS	DATE	APPROVED	REVISIONS	DATE	APPROVED

DATE	DESCRIPTION	SCALE: N/A	VIEW:	UNIT: mm	SIZE: A4

WEIGHT	SHEET	REVISION
1.0g	1/1	A0

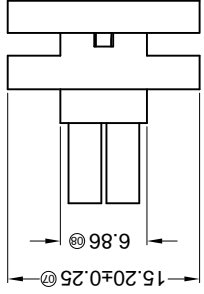
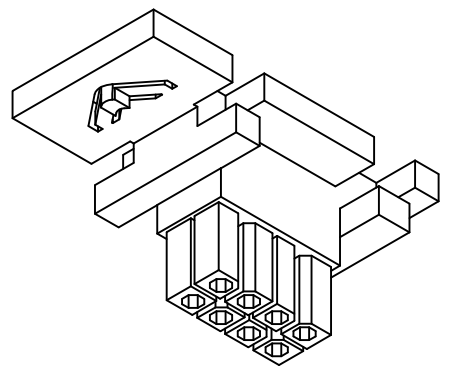
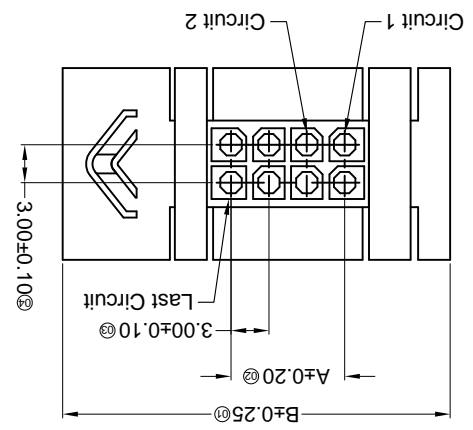
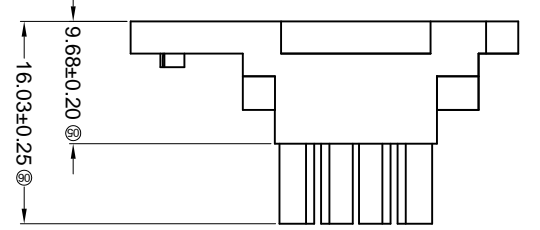
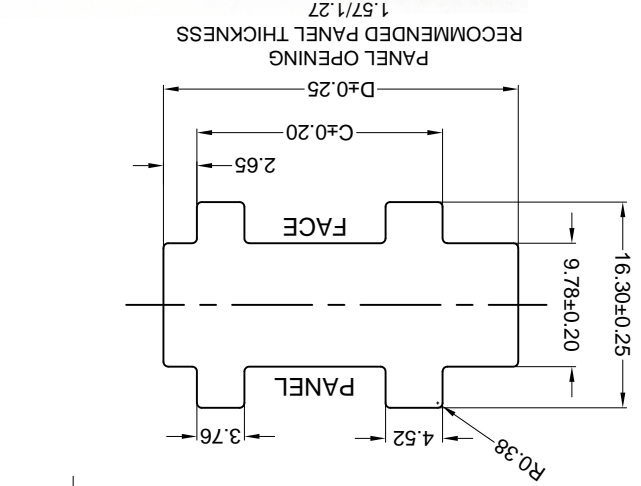

PART NO	Material	Suitable SWB Terminal	Mates With XKB Wafer
X3025HM-2*XXWS-N2	Nylon 66 94V-2	X3025TF	X3025W

Poles	A	B	C	D
2*02	3.00	24.60	13.46	22.10
2*03	6.00	27.70	16.46	25.10
2*04	9.00	30.70	19.46	28.10
2*05	12.00	33.80	22.46	31.10
2*06	15.00	36.80	25.46	34.10
2*07	18.00	39.90	28.46	37.10
2*08	21.00	42.90	31.46	40.10
2*09	24.00	46.00	34.46	43.10
2*10	27.00	49.00	37.46	46.10
2*11	30.00	51.80	40.46	49.10
2*12	33.00	54.90	43.46	52.10

Dimensions(mm)

- ① Series No.
- ② Category: H-HSG
- ③ Welding Board Angle: M-Male HSG
- ④ Row No.-Pin No.: 2*XX-2*02P~2*10P
- ⑤ Plug the Pin & special No.: WS-With Base
- ⑥ Material: N2-PA66 94V-2;
- ⑦ Color: Blank-natural color Black

X3025 H M-2*XX WS-N2 XX

- Specifications :
- Voltage rating: 250V AC / DC
- Current rating: 5A AC / DC
- Withstanding voltage: 1500V AC/minute
- Temperature range: -25°C~+85°C
- Insulation resistance: ≥1000MΩ
- Contact resistance: ≤10mΩ
- After environmental testing: ≤20mΩ

REVISIONS
Authorized Signatures(s)

MARK	DESCRIPTION	DATE	REVISED	APPROVED	UNSPECIFIED TOLERANCES
△ X					L > 63
△ X					16 < L ≤ 63
△ X					4 < L ≤ 16
					L ≤ 4
					ANGULAR

For and on behalf of
KXB INDUSTRIAL PRECISION CO., LIMITED
香港星坤工業精密有限公司

KXB INDUSTRIAL PRECISION CO., LIMITED

MODEL TYPE:	X3025HM-2*XX-N2
PART NO.:	X3025HM-2*XX-N2
3.00 mm Crimp Style Connectors	
DMG NO.:	
SIZE: A4	
UNIT: mm	
DATE	
DATE	
DATE	
DATE	
SCALE: N/A	
WEIGHT	1.0g
SHEET	1/1
REVISION	A0

PART NO	X3025HM-2*XX-N2	Material	Nylon 66 94V-2	Suitable SWB Terminal	X3025TF	Mates With XKB Water	X3025W
---------	-----------------	----------	----------------	-----------------------	---------	----------------------	--------

Poles	Dimensions(mm)		Poles	Dimensions(mm)	
	A	B		A	B
2*01	2*07	18.00	2*12	2*07	21.85
2*02	3.00	24.00	2*08	2*08	24.85
2*03	6.00	27.85	2*09	2*09	27.85
2*04	9.00	30.85	2*10	2*10	30.85
2*05	12.00	33.85	2*11	2*11	33.85
2*06	15.00	36.85	2*12	2*12	36.85

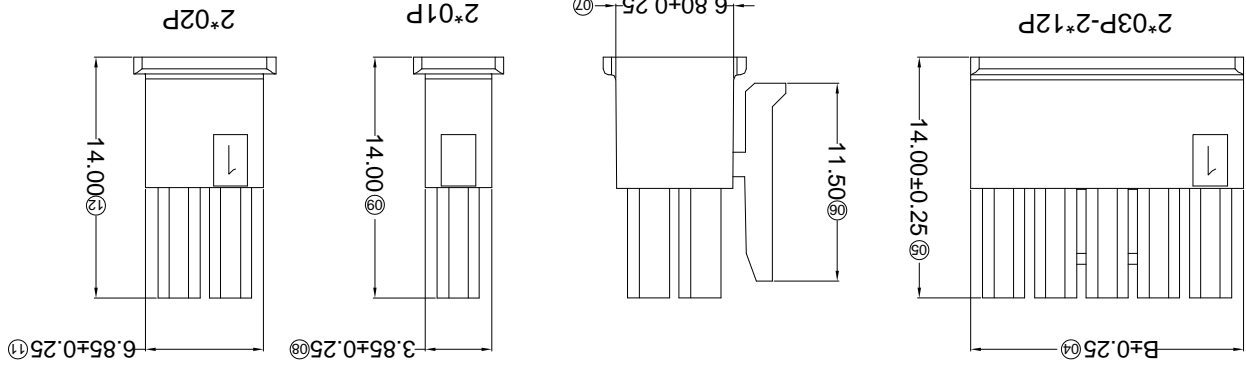
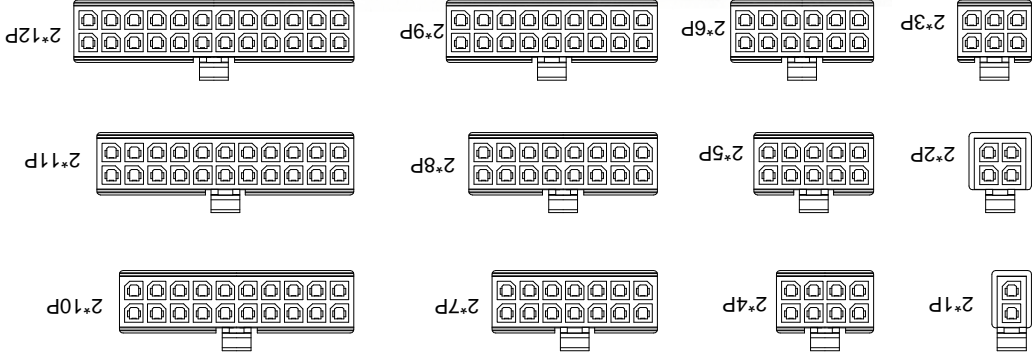

X3025 H M-2*XX XX-N2 XX

① Series No.

② Category: H-HSG

③ Welding Board Angle: M-Male HSG

④ Row No.-Pin No.: 2*XX-2*01P~2*12P

⑤ Plug the Pin & special No.:

⑥ Material: N2-PA66 94V-2;

⑦ Color: Blank-Natural Color

- Specifications :
- Voltage rating: 250V AC / DC
 - Current rating: 5A AC / DC
 - Withstanding voltage: 1000V AC/minute
 - Temperature range: -25°C~+85°C
 - Insulation resistance: ≥1000MΩ
 - Contact resistance: ≤10mΩ
 - After environmental testing: ≤20mΩ

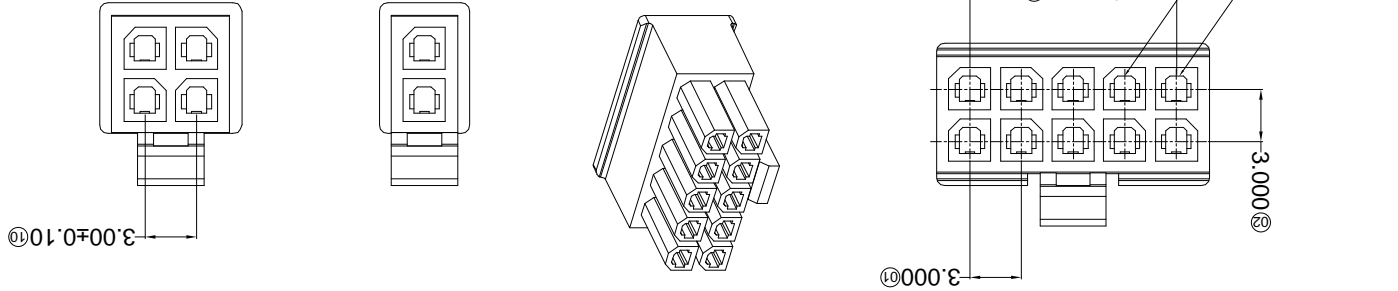

For and on behalf of
KKB INDUSTRIAL PRECISION CO., LIMITED
 香港星坤工業精密有限公司

REVISIONS
 Authorized Signature(s)

MARK	DESCRIPTION	DATE	REVISED	APPROVED	UNSPECIFIED TOLERANCES
△ X					L > 63 ± 0.5
△ X					16 < L ≤ 63 ± 0.4
△ X					4 < L ≤ 16 ± 0.3
△ X					L ≤ 4 ± 0.2
					ANGULAR ± 5°

REVISION	SHEET	WEIGHT	DATE	DATE	DATE	DATE	DATE
A0	1/1	1.0g					

KKB INDUSTRIAL PRECISION CO., LIMITED	SIZE: A4	UNIT: mm	VIEW:	SCALE: N/A
APPD		DATE		
CHKD		DATE		
DWN		DATE		
DSND		DATE		

MODEL TYPE: X3025HR-2*XX-LPSN	PART NO.:	3.00 mm Crimp Style Connectors	DWG NO.:
-------------------------------	-----------	--------------------------------	----------

Part No.	Material	Material(Pin)	Finish(Pin)	Mates With XKB Housing
X3025HR-2*XX-LPSN	LCP UL 94V-0	Brass	Tin-Plated	X3025HW or 3025H

Poles	Dimensions(mm)		
	A	B	C
2'02	3.00	6.70	2'08
2'03	6.00	9.70	2'09
2'04	9.00	12.70	2'10
2'05	12.00	15.70	2'11
2'06	15.00	18.70	2'12
2'07	18.00	21.70	15.00

Poles	Dimensions(mm)		
	A	B	C
2'02	21.00	24.70	18.00
2'03	24.00	27.70	21.00
2'04	27.00	30.70	24.00
2'05	30.00	33.70	27.00
2'06	33.00	36.70	30.00
2'07	36.00	39.70	33.00

- ① Series No.
- ② Category: H-HSG
- ③ Welding Board Angle: BOARD-IN-R-90°
- ④ Row No.-Pin No.: 2*XX-2*02P~2*12P
- ⑤ Plug the Pin & special No.:
- ⑥ Material: LP-LCP 94V-0;
- ⑦ Plating Category: SN-Bright tin plating
- ⑧ Color: Blank-Natural Color

X3025 H R-2*XX LP SN XX
 ① ② ③ ④ ⑤ ⑥ ⑦ ⑧

- Specifications :
- Voltage rating: 250V AC / DC
 - Current rating: 5A AC / DC
 - Withstanding voltage: 1000V AC/minute
 - Temperature range: -25°C~+85°C
 - Insulation resistance: ≥1000MΩ
 - Contact resistance: ≤10mΩ
 - After environmental testing: ≤20mΩ

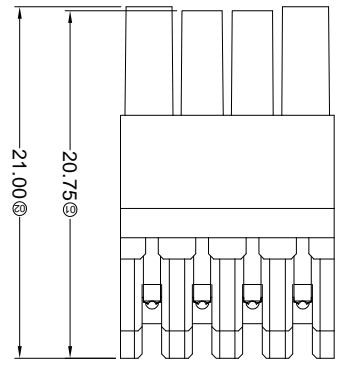
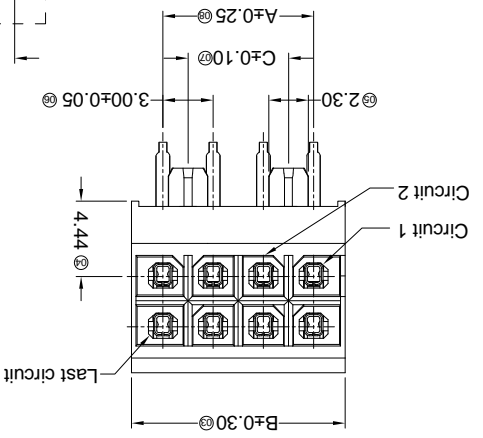
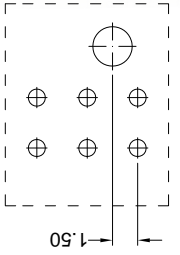
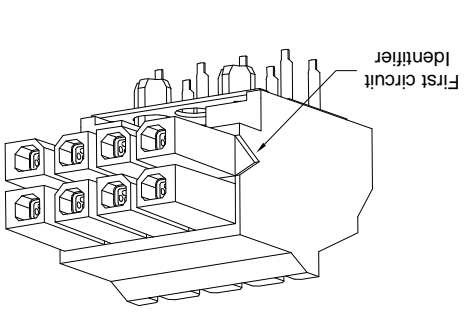
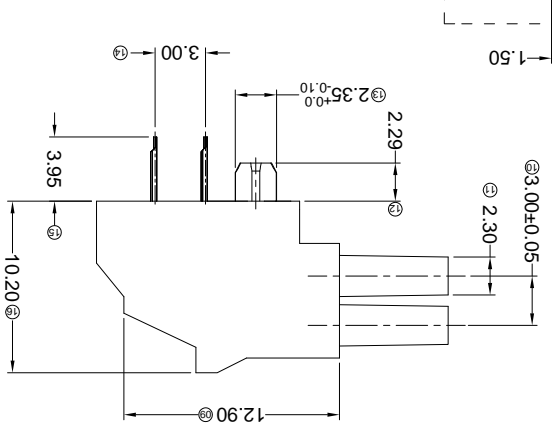
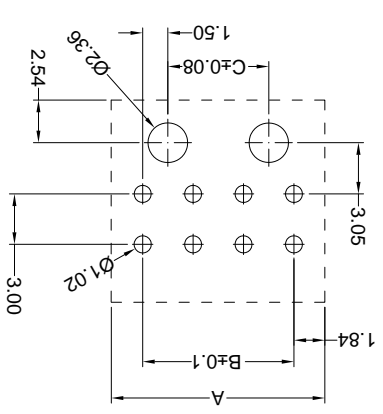

For and on behalf of
KRB INDUSTRIAL PRECISION CO., LIMITED
 香港星坤工業精密有限公司

REVISIONS
 Authorized Signature(s)

MARK	DESCRIPTION	DATE	REVISED	APPROVED	UNSPECIFIED TOLERANCES
△ X					L > 63 ±0.5
△ X					16 < L ≤ 63 ±0.4
△ X					4 < L ≤ 16 ±0.3
△ X					L ≤ 4 ±0.2
					ANGULAR ±5°

DSND	DATE	SCALE: N/A	MODEL TYPE: X3025HV-2*XX-LPSN
DWN	DATE <td>VIEW: </td> <td>PART NO.: 3.00 mm Crimp Style Connectors</td>	VIEW:	PART NO.: 3.00 mm Crimp Style Connectors
CHKD	DATE <td>UNIT: mm</td> <td>DWG NO.:</td>	UNIT: mm	DWG NO.:
APPD	DATE <td>SIZE: A4</td> <td>WEIGHT 1.0g</td>	SIZE: A4	WEIGHT 1.0g
			SHEET 1/1
			REVISION A0

Recommended P.C.B Layout

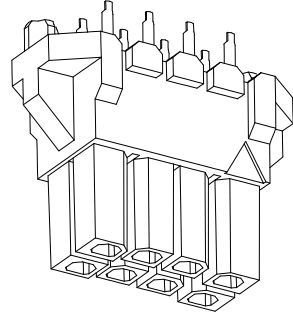
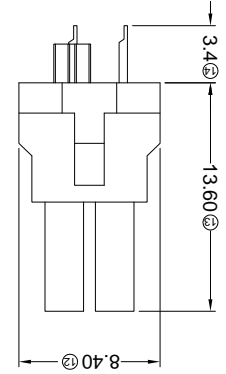
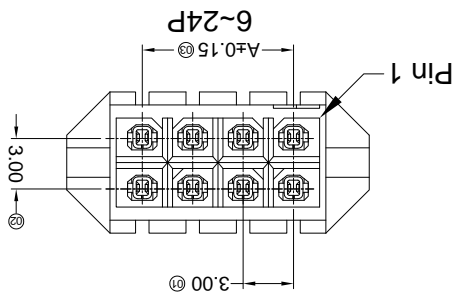
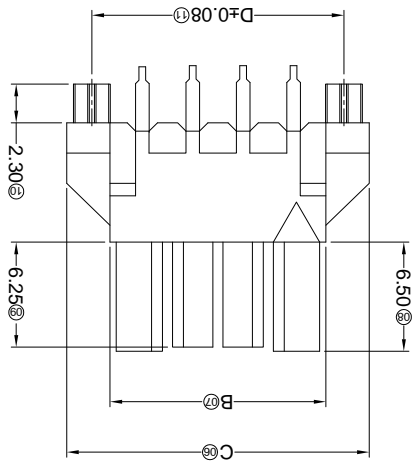
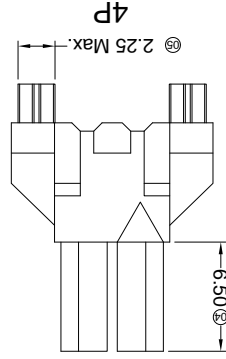
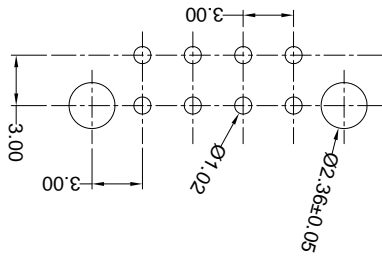

Part No.	Material	Material(Pin)	Finish(Pin)	Mates With KRB Housing
X3025HV-2*XX-LPSN	LCP UL 94V-0	Brass	Tin-Plated	X3025HW or 3025H

Poles	Dimensions(mm)			
	A	B	C	D
2*02	3.00	6.85	12.00	9.00
2*03	6.00	9.85	15.00	12.00
2*04	9.00	12.85	18.00	15.00
2*05	12.00	15.85	21.00	18.00
2*06	15.00	18.85	24.00	21.00
2*07	18.00	21.85	27.00	24.00
2*08	21.00	24.85	30.00	27.00
2*09	24.00	27.85	33.00	30.00
2*10	27.00	30.85	36.00	33.00
2*11	30.00	33.85	39.00	36.00
2*12	33.00	36.85	42.00	39.00

- ① Series No.
- ② Category: H-HSG
- ③ Welding Board Angle: BOARD-IN: V-180°
- ④ Row No.-Pin No.: 2*XX-2*02P~2*12P
- ⑤ Plug the Pin & special No.:
- ⑥ Material: LP-LCP 94V-0;
- ⑦ Plating Category: SN-Bright tin plating
- ⑧ Color: Blank-Natural Color

X3025 H V-2*XX-LP SN XX

- Specifications:
- Voltage rating: 250V AC / DC
 - Current rating: 5A AC / DC
 - Withstanding voltage: 1000V AC/minute
 - Temperature range: -25°C~+85°C
 - Insulation resistance: ≥1000MΩ
 - Contact resistance: ≤10mΩ
 - After environmental testing: ≤20mΩ

For and on behalf of
XKB INDUSTRIAL PRECISION CO., LIMITED
 香港星坤工業精密有限公司

REVISIONS
 Authorized Signature(s)

MARK	DESCRIPTION	DATE	REVISED	APPROVED	UNSPECIFIED TOLERANCES
△ X					L > 63 ± 0.5
△ X					16 > L ≤ 63 ± 0.4
△ X					4 < L ≤ 16 ± 0.3
△ X					L ≤ 4 ± 0.2
					ANGULAR ± 5°

DSND	DATE	SCALE: N/A	MODEL TYPE: X3025TF-PXXX
DWN	DATE	VIEW:	PART NO.:
CHKD	DATE	UNIT: mm	DWG NO.:
APPD	DATE	SIZE: A4	REVISION
			WEIGHT 1.0g
			SHEET 1/1
			REVISION A0

PART NO	Material	Wire Range	Insulation O.D.	Finish	Used in XKB Housing
X3025TF-PG30	Phosphor Bronze	AWG#20-24	1.85mm(Max)	Stamping Before Plating:30~50u" Ni;Contact Area Gold:30u" Min.	X3025HM
X3025TF-PG15				Stamping Before Plating:30~50u" Ni;Contact Area Gold:15u" Min.	
X3025TF-PG01				Stamping Before Plating:30~50u" Ni;Contact Area Gold Flash	
X3025TF-PSN				Stamping Before Plating:30~50u" Ni;70~120u" Sn	

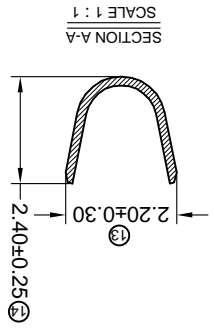
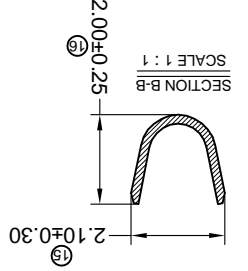
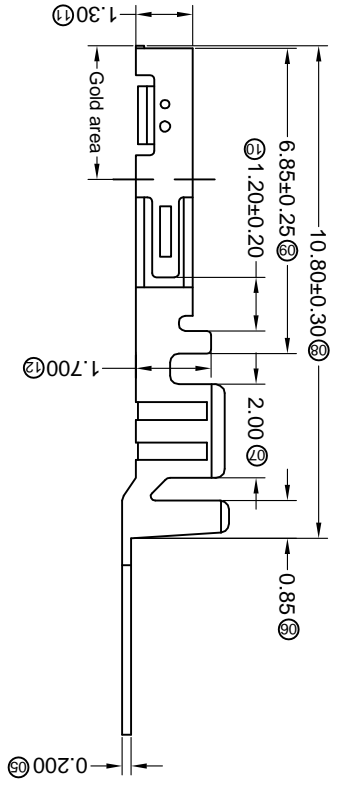
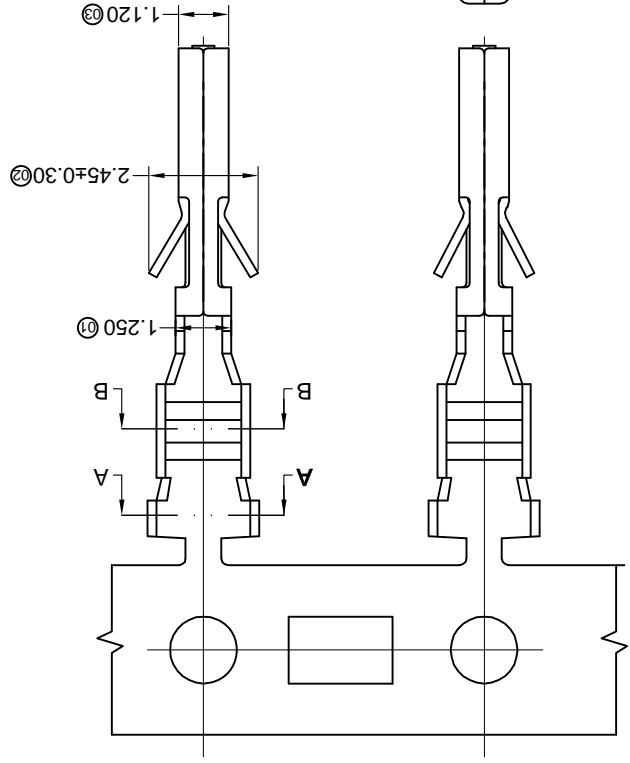
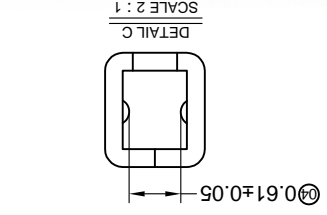

■ Specifications :

- Voltage rating: 250V AC / DC
- Current rating: 5A AC / DC
- Withstanding voltage: 1000V AC/minute
- Temperature range: -40°C~+85°C
- Insulation resistance: ≥1000MΩ
- Contact resistance: ≤10mΩ
- After environmental testing: ≤20mΩ

X3025 T F-P XX X-X
 ①① ①② ①③ ①④ ①⑤ ①⑥ ①⑦

- ① Series Number
- ② Category: T-terminal
- ③ Shape: F-Female Terminal
- ④ Material: P-Phosphor bronze
- ⑤ Plating style:
- ⑥ G-Gold-Plated Contact
- ⑦ *01-Gold Flash *15-15u" *30-30u"
- ⑧ SN-Bright tin plating 70-120u"
- ⑨ Plating method:
- ⑩ Blank-Stamping before plating
- ⑪ Mold No./Mark/Special No.

REVISIONS
Authorized Signature(s)

For and on behalf of
XKB INDUSTRIAL PRECISION CO., LIMITED
香港星坤工業精密有限公司

MARK	DESCRIPTION	DATE	REVISED	APPROVED	UNSPECIFIED TOLERANCES
△ X					L > 63
△ X					16 > L ≤ 63
△ X					4 < L ≤ 16
△ X					L ≤ 4
					ANGULAR ± 5°

DATE	SCALE: N/A	MODEL TYPE: X3025TM-PXX
DATE	VIEW:	PART NO.:
DATE	UNIT: mm	DWG NO.:
DATE	SIZE: A4	REVISION
DATE		SHEET
DATE		1/1
DATE		WEIGHT
DATE		1.0g

PART NO	Material	Wire Range	Insulation O.D.	Finish
X3025TM-PSN	Phosphor Bronze AWG#20-24	1.85mm(Max)		Stamping Before Plating:30u" Ni;70u" Sn
X3025TM-PG01				Stamping Before Plating:30u" Ni>Contact Area Gold Flash
X3025TM-PG15				Stamping Before Plating:30u" Ni>Contact Area Gold:15u" Min.
X3025TM-PG30				Stamping Before Plating:30u" Ni>Contact Area Gold:30u" Min.

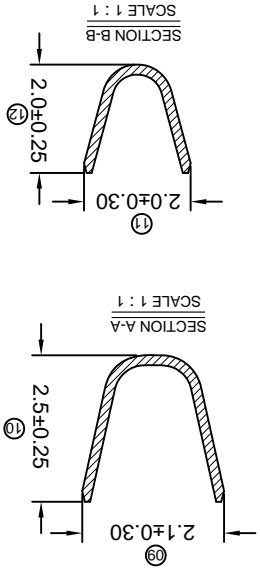
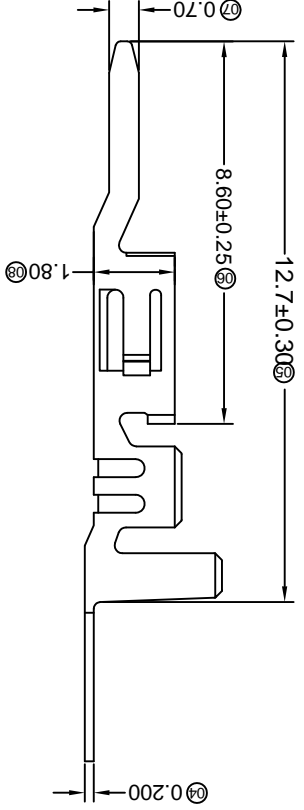
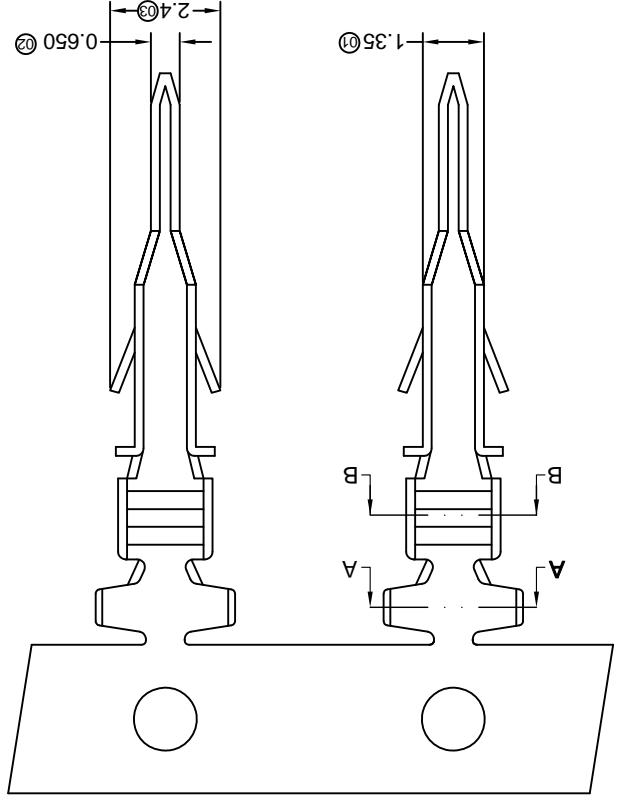

- Specifications :**
- Voltage rating: 250V AC / DC
 - Current rating: 5A AC / DC
 - Withstanding voltage: 1000V AC/minute
 - Temperature range: -25°C~+85°C
 - Insulation resistance: ≥1000MΩ
 - Contact resistance: ≤10mΩ
 - After environmental testing: ≤20mΩ
- X3025 T-M-P XX X-X**
- ① Series Number
 - ② Category: T-terminal
 - ③ Shape: M-Male Terminal
 - ④ Material: P-Phosphor bronze
 - ⑤ Plating style: G-Gold-Plated Contact
 - ⑥ Plating method: SN-Bright tin plating 70u"
 - ⑦ *01-Gold Flash *15-15u" *30-30u"
 - ⑧ Mold No./Mark/Special No.

A B C D E F

8 7 6 5 4 3 2 1

A B C D E F

8 7 6 5 4 3 2 1

For and on behalf of
KKB INDUSTRIAL PRECISION CO., LIMITED
 香港星坤工業精密有限公司

REVISIONS
 Authorized Signatures(s)

MARK	DESCRIPTION	DATE	REVISED	APPROVED	UNSPECIFIED TOLERANCES
△ X					L > 63 ± 0.5
△ X					16 > L ≤ 63 ± 0.4
△ X					4 < L ≤ 16 ± 0.3
					L ≤ 4 ± 0.2
					ANGULAR ± 5°

DATE	SCALE: N/A	MODEL TYPE: X3025WR-2*XX-N0XXX	VIEW:	DATE	DATE	DATE	SIZE: A4	WEIGHT: 1.0g	SHEET: 1/1	REVISION: A0
DNSD										
DWN										
CHKD										
APPD										

2P P.C.B LAYOUT

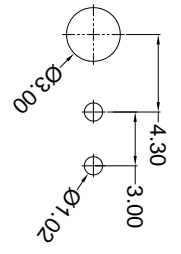

4P-6P P.C.B LAYOUT

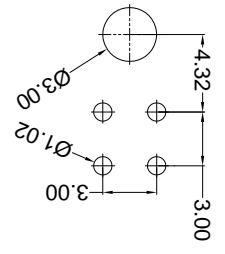

8P-24P P.C.B LAYOUT

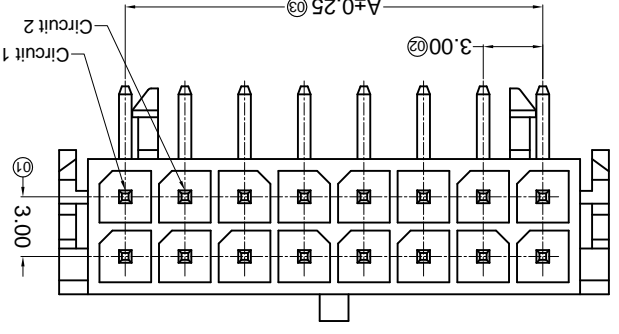
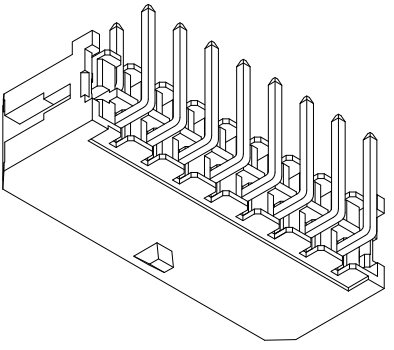
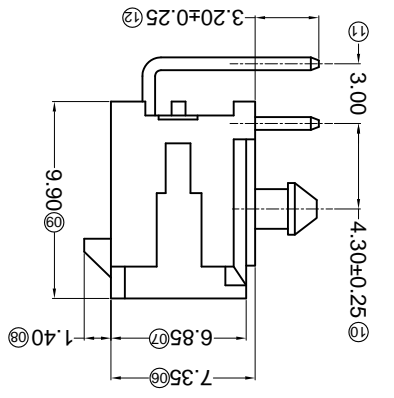
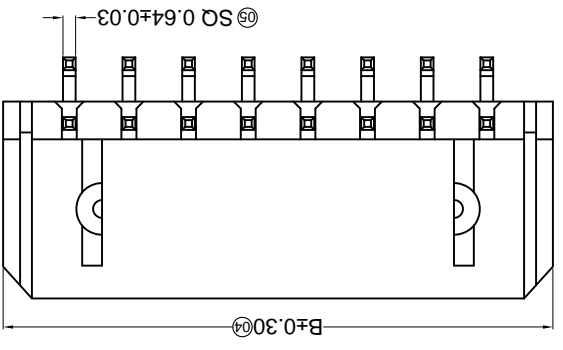
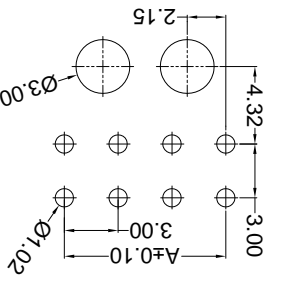

Part No.	Material	Material(Pin)	Finish(Pin)	Mates With XKB Housing
X3025WR-2*XX-46SN	PA46 UL 94V-0	Brass	Tin-Plated	X3025H
X3025WR-2*XX-46G01	PA46 UL 94V-0	Brass	Contact Gold	

Scale 1:3

Dimensions (mm)	Poles	
	A	B
2*01	---	6.65
2*02	3.00	9.65
2*03	6.00	12.65
2*04	9.00	15.65
2*05	12.00	18.65
2*06	15.00	21.65
2*07	18.00	24.65
2*08	21.00	27.65
2*09	24.00	30.65
2*10	27.00	33.65
2*11	30.00	36.65
2*12	33.00	39.65

- ① Series No.
- ② Category: W-water
- ③ Welding Board Angle: R-90°
- ④ Welding Way: Blank-DIP
- ⑤ Row No.-Pin No.: 2*XX-2*01P-2*12P
- ⑥ Special NO.:
- ⑦ Material: 46-PA46 94V-0
- ⑧ Planting Category: G01-Contact Gold Flash
- ⑨ Plating Category: SN-Bright tin plating
- ⑩ Color: Blank-natural color

- Specifications:
- Voltage rating: 250V AC / DC
- Current rating: 5A AC / DC
- Withstanding voltage: 1000V AC/minute
- Temperature range: -25°C~+85°C
- Insulation resistance: ≥1000MΩ
- Contact resistance: ≤10mΩ
- After environmental testing: ≤20mΩ

REVISIONS
Authorized Signature(s)

MARK	DESCRIPTION	DATE	REVISED	APPROVED	UNSPECIFIED TOLERANCES
△ X					L > 63 ± 0.5
△ X					16 < L ≤ 63 ± 0.4
△ X					4 < L ≤ 16 ± 0.3
					L ≤ 4 ± 0.2
					ANGULAR ± 5°

For and on behalf of
KXB INDUSTRIAL PRECISION CO., LIMITED
香港星坤工業精密有限公司

KXB INDUSTRIAL PRECISION CO., LIMITED

MODEL TYPE:	X3025WR-2*XXB-XXSN
PART NO.:	
VIEW:	
UNIT:	mm
DATE:	
DATE:	
SIZE:	A4
WEIGHT:	1.0g
SHEET:	1/1
REVISION:	A0

Poles	Dimensions (mm)		Poles	Dimensions (mm)	
	A	B		A	B
2*01	---	6.65	2*07	18.00	24.65
2*02	3.00	9.65	2*08	21.00	27.65
2*03	6.00	12.65	2*09	24.00	30.65
2*04	9.00	15.65	2*10	27.00	33.65
2*05	12.00	18.65	2*11	30.00	36.65
2*06	15.00	21.65	2*12	33.00	39.65

Part No.	Material	Material (Pin)	Finish (Pin)	Mates With
X3025WR-2*XXB-L-PSN	LCP UL 94V-0	Brass	Tin-Plated	X3025H
X3025WR-2*XXB-46SN	Nylon 46 UL 94V-0			
X3025WR-2*XXB-66SN	Nylon 66 UL 94V-0			

Recommended P.C.B Layout
General Tolerance ± 0.05

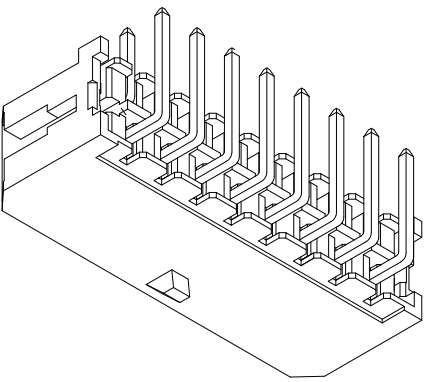
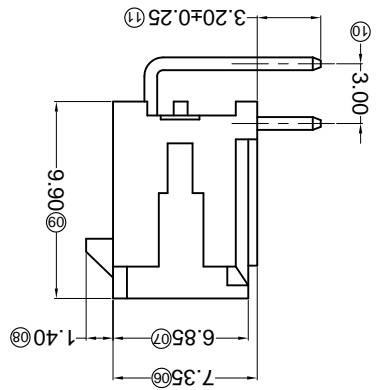
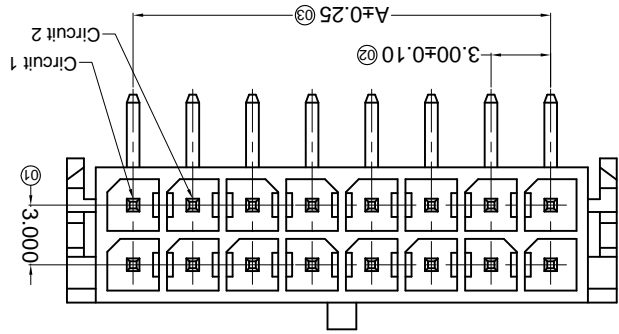
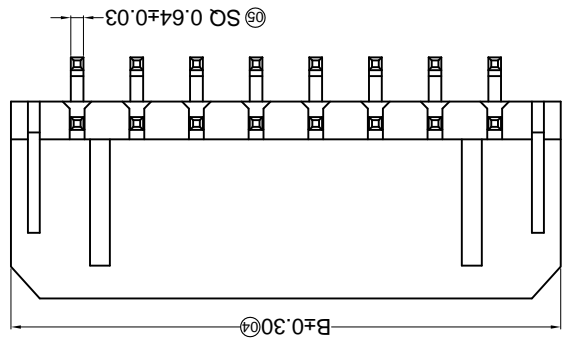
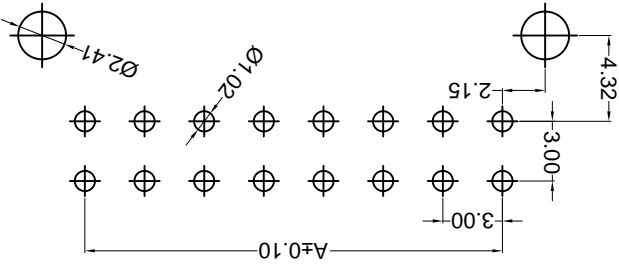

Specifications :

- Voltage rating: 250V AC / DC
- Current rating: 5A AC / DC
- Withstanding voltage: 1000V AC/minute
- Temperature range: -25°C~+85°C
- Insulation resistance: ≥ 1000MΩ
- Contact resistance: ≤ 10mΩ
- After environmental testing: ≤ 20mΩ

X3025 W R X- 2*XX B-XX XX XX
 ① Series No.
 ② Category: W-water
 ③ Welding Board Angle: R-90°
 ④ Welding Way: Blank-DIP
 ⑤ Row No.-Pin No.: 2*XX-2*01P-2*12P
 ⑥ Special NO.: B-Without positioning column
 ⑦ Material:
 ⑧ 46-PA46 94V-0 66-PA66 94V-0 LP-LCP 94V-0
 ⑨ Plating Category: SN-Bright tin plating
 ⑩ Color: Blank-natural color

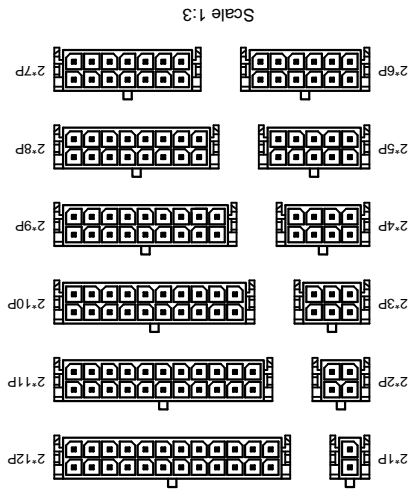

For and on behalf of
KRB INDUSTRIAL PRECISION CO., LIMITED
 香港星坤工業精密有限公司

MARK	DESCRIPTION	DATE	REVISIONS	APPROVED	REVISOR	DATE
△ X						
△ X						
△ X						

UNSPECIFIED TOLERANCES	APPROVED	REVISOR	DATE
L > 63			
16 < L ≤ 63			
4 < L ≤ 16			
L ≤ 4			
ANGULAR			

REVISION	SHEET	WEIGHT	DATE	DATE	DATE	DATE
A0	1/1	1.0g				

MODEL TYPE	SCALE	DATE	DATE	DATE	DATE
X3025WR-2*XXC-XXX	N/A				

Part No.	Material	Material (P/n)	Finish (P/n)	Mates With (P/n)
X3025WR-2*XXC-66G02	Nylon 66 UL 94V-0		Gold Flash	X3025H
X3025WR-2*XXC-L-PSN	LCP UL 94V-0		Tin-Plated	
X3025WR-2*XXC-46SN	Nylon 46 UL 94V-0			
X3025WR-2*XXC-66SN	Nylon 66 UL 94V-0			

Recommended P.C.B Layout
 General Tolerance ±0.05

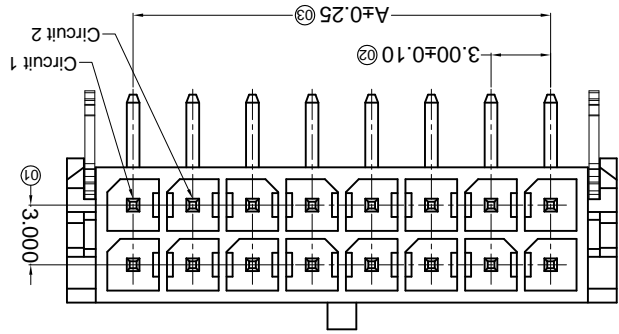
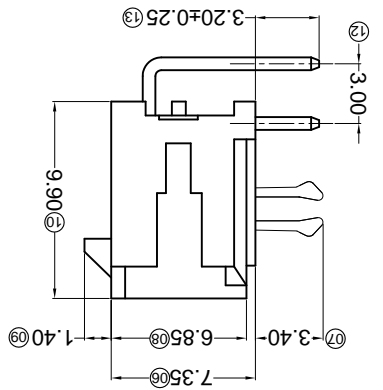
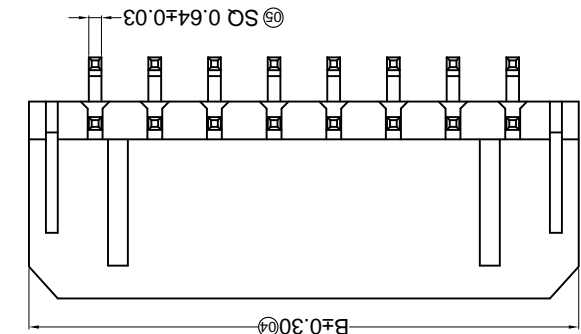
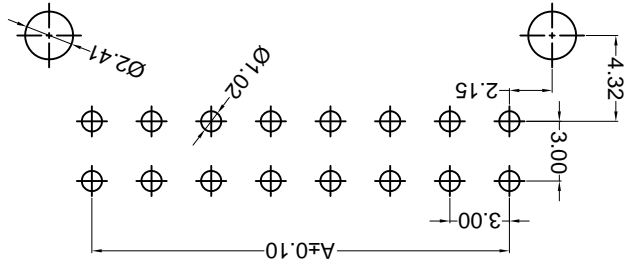

Specifications :

- Voltage rating: 250V AC / DC
- Current rating: 5A AC / DC
- Withstanding voltage: 1000V AC/minute
- Temperature range: -25°C~+85°C
- Insulation resistance: ≥1000MΩ
- Contact resistance: ≤10mΩ
- After environmental testing: ≤20mΩ

- ① Series No.
- ② Category: W-water
- ③ Welding Board Angle: R-90°
- ④ Welding Way: Blank-DIP
- ⑤ Row No.-Pin No.: 2*XX-2*01P~2*12P
- ⑥ Special NO.: C-The harpoon
- ⑦ Material:
- ⑧ 46-P A46 94V-0 66-PA66 94V-0 LP-LCP 94V-0 Planting Category:
- ⑨ G*:Gold-Plated Contact *02-2u"
- ⑩ SN-Bright tin plating 70u"
- ⑪ Color: Blank-natural color

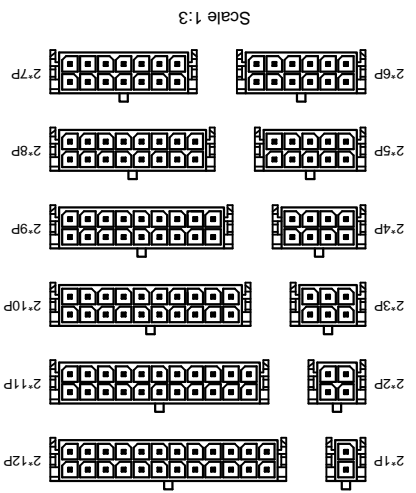

Poles	A	B	Dimensions (mm)
2*01	---	6.65	
2*02	3.00	9.65	
2*03	6.00	12.65	
2*04	9.00	15.65	
2*05	12.00	18.65	
2*06	15.00	21.65	
2*07	18.00	24.65	
2*08	21.00	27.65	
2*09	24.00	30.65	
2*10	27.00	33.65	
2*11	30.00	36.65	
2*12	33.00	39.65	

For and on behalf of
KXB INDUSTRIAL PRECISION CO., LIMITED
 香港星坤工業精密有限公司

REVISIONS
 (Authorized Signatures)

MARK	DESCRIPTION	DATE	REVISED	APPROVED	UNSPECIFIED TOLERANCES
△ X					L > 63
△ X					16 < L ≤ 63
△ X					4 < L ≤ 16
△ X					L ≤ 4
					ANGULAR
					± 5°

DATE	DATE	DATE	DATE	DATE	DATE	DATE	DATE	DATE	DATE
DSND	DWN	CHKD	APPD						
SCALE: N/A	VIEW:	UNIT: mm	SIZE: A4						
MODEL TYPE: X3025WR-2*XXH-LPSN	PART NO.:	3.00 mm Crimp Style Connectors		DWG NO.:					
WEIGHT: 1.0g	SHEET: 1/1	REVISION: A0							

PCB LAYOUT: Component side

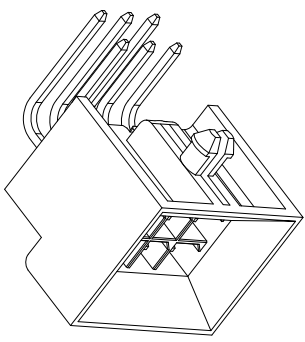
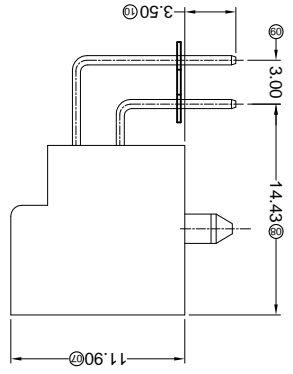
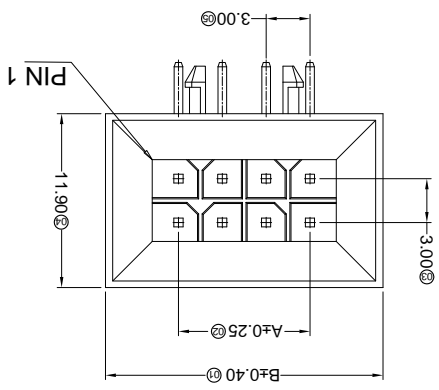
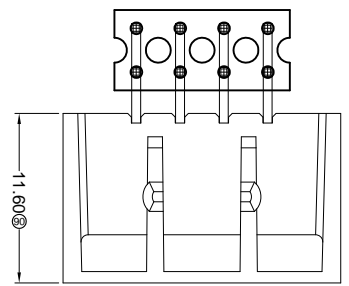
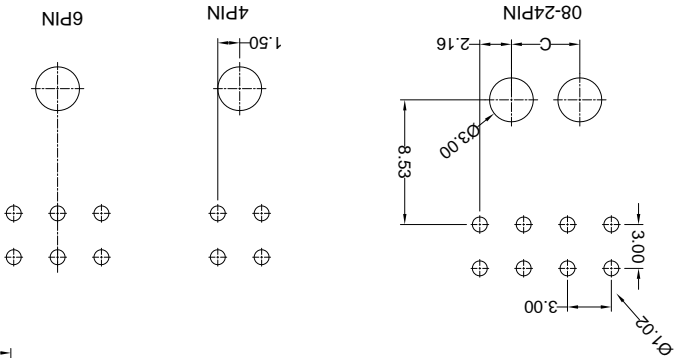

Part No.	Material	Material(Pin)	Finish(Pin)	Mates With XKB Housing
X3025WR-2*XXH-LPSN	LCP UL 94V-0	Brass	Tin-Plated	X3025H

Poles	Dimensions (mm)		
	A	B	C
2*02	3.00	13.00	2*08
2*03	6.00	16.00	2*09
2*04	9.00	19.00	4.68
2*05	12.00	22.00	7.68
2*06	15.00	25.00	10.68
2*07	18.00	28.00	13.68

- ① Series No. X3025 W R X-2*XX H-LP SN XX
- ② ③ ④ ⑤ ⑥ ⑦ ⑧ ⑨
- ① Series No.
 - ② Category: W-water
 - ③ Welding Board Angle: R-90°
 - ④ Welding Way: Blank-DIP
 - ⑤ Row No.-Pin No.: 2*XX-2*01P~2*12P
 - ⑥ Special NO.: H-With Base and positioning column
 - ⑦ Material: LP-LCP 94V-0
 - ⑧ Planting Category: SN-Bright tin plating
 - ⑨ Color: Blank-natural color

- Specifications:**
- Voltage rating: 250V AC / DC
 - Current rating: 5A AC / DC
 - Withstanding voltage: 1500V AC/minute
 - Temperature range: -25°C~+85°C
 - Insulation resistance: ≥1000MΩ
 - Contact resistance: ≤10mΩ
 - After environmental testing: ≤20mΩ

REVISIONS
(Unauthorized Signatures)

MARK	DESCRIPTION	DATE	REVISED	APPROVED	UNSPECIFIED TOLERANCES
△ X					L > 63 ± 0.5
△ X					16 < L ≤ 63 ± 0.4
△ X					4 < L ≤ 16 ± 0.3
△ X					L ≤ 4 ± 0.2
					ANGULAR ± 5°

For and on behalf of
KXB INDUSTRIAL PRECISION CO., LIMITED
香港星坤工業精密有限公司

KXB INDUSTRIAL PRECISION CO., LIMITED

DATE	SCALE: N/A	MODEL TYPE:
		X3025WRS-2*XXA-LPXX
DATE	VIEW:	PART NO.:
DATE	UNIT: mm	DWG NO.:
		3.00 mm Crimp Style Connectors
DATE	SIZE: A4	REVISION
		A0
WEIGHT	SHEET	8
1.0g	1/1	

PART NO	Material	Material(Pin)	Finish(Pin)	Mates With XKB Housing
X3025WRS-2*XXA-LP5W	LCP UL 94V-0	Brass	Tin-Plated	X3025H
X3025WRS-2*XXA-LP5W	LCP UL 94V-0	Brass	Mate Tin Plating	

Poles	Dimensions (mm)		
	A	B	C
2*01	6.65	2*07	18.00
2*02	3.00	2*08	21.00
2*03	6.00	2*09	24.00
2*04	9.00	2*10	27.00
2*05	12.00	2*11	30.00
2*06	15.00	2*12	33.00
2*07	18.00	2*13	36.00
2*08	21.00	2*14	39.00
2*09	24.00	2*15	42.00
2*10	27.00	2*16	45.00
2*11	30.00	2*17	48.00
2*12	33.00	2*18	51.00
2*13	36.00	2*19	54.00
2*14	39.00	2*20	57.00
2*15	42.00	2*21	60.00
2*16	45.00	2*22	63.00
2*17	48.00	2*23	66.00
2*18	51.00	2*24	69.00
2*19	54.00	2*25	72.00
2*20	57.00	2*26	75.00
2*21	60.00	2*27	78.00
2*22	63.00	2*28	81.00
2*23	66.00	2*29	84.00
2*24	69.00	2*30	87.00
2*25	72.00	2*31	90.00
2*26	75.00	2*32	93.00
2*27	78.00	2*33	96.00
2*28	81.00	2*34	99.00
2*29	84.00	2*35	102.00
2*30	87.00	2*36	105.00
2*31	90.00	2*37	108.00
2*32	93.00	2*38	111.00
2*33	96.00	2*39	114.00
2*34	99.00	2*40	117.00
2*35	102.00	2*41	120.00
2*36	105.00	2*42	123.00
2*37	108.00	2*43	126.00
2*38	111.00	2*44	129.00
2*39	114.00	2*45	132.00
2*40	117.00	2*46	135.00
2*41	120.00	2*47	138.00
2*42	123.00	2*48	141.00
2*43	126.00	2*49	144.00
2*44	129.00	2*50	147.00
2*45	132.00	2*51	150.00
2*46	135.00	2*52	153.00
2*47	138.00	2*53	156.00
2*48	141.00	2*54	159.00
2*49	144.00	2*55	162.00
2*50	147.00	2*56	165.00
2*51	150.00	2*57	168.00
2*52	153.00	2*58	171.00
2*53	156.00	2*59	174.00
2*54	159.00	2*60	177.00
2*55	162.00	2*61	180.00
2*56	165.00	2*62	183.00
2*57	168.00	2*63	186.00
2*58	171.00	2*64	189.00
2*59	174.00	2*65	192.00
2*60	177.00	2*66	195.00
2*61	180.00	2*67	198.00
2*62	183.00	2*68	201.00
2*63	186.00	2*69	204.00
2*64	189.00	2*70	207.00
2*65	192.00	2*71	210.00
2*66	195.00	2*72	213.00
2*67	198.00	2*73	216.00
2*68	201.00	2*74	219.00
2*69	204.00	2*75	222.00
2*70	207.00	2*76	225.00
2*71	210.00	2*77	228.00
2*72	213.00	2*78	231.00
2*73	216.00	2*79	234.00
2*74	219.00	2*80	237.00
2*75	222.00	2*81	240.00
2*76	225.00	2*82	243.00
2*77	228.00	2*83	246.00
2*78	231.00	2*84	249.00
2*79	234.00	2*85	252.00
2*80	237.00	2*86	255.00
2*81	240.00	2*87	258.00
2*82	243.00	2*88	261.00
2*83	246.00	2*89	264.00
2*84	249.00	2*90	267.00
2*85	252.00	2*91	270.00
2*86	255.00	2*92	273.00
2*87	258.00	2*93	276.00
2*88	261.00	2*94	279.00
2*89	264.00	2*95	282.00
2*90	267.00	2*96	285.00
2*91	270.00	2*97	288.00
2*92	273.00	2*98	291.00
2*93	276.00	2*99	294.00
2*94	279.00	2*100	297.00
2*95	282.00	2*101	300.00
2*96	285.00	2*102	303.00
2*97	288.00	2*103	306.00
2*98	291.00	2*104	309.00
2*99	294.00	2*105	312.00
2*100	297.00	2*106	315.00

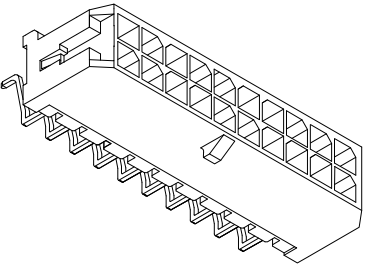
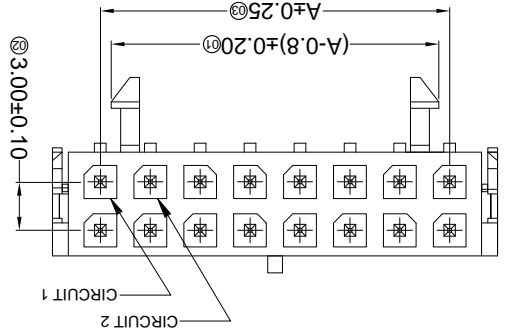
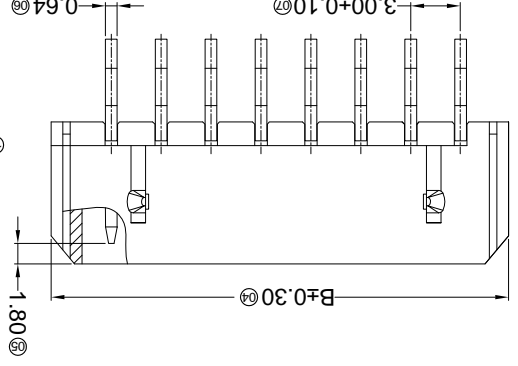
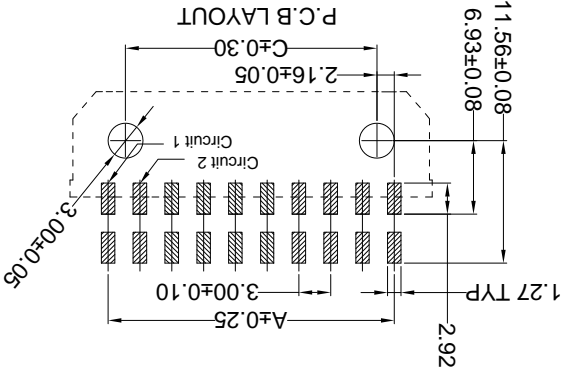
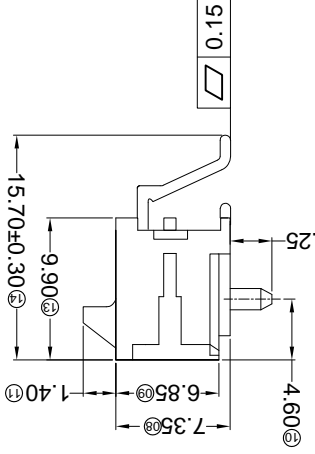
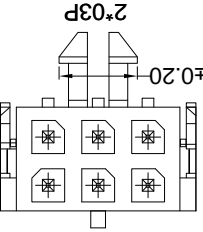

- ① Series No.
② Category: W-water
③ Welding Board Angle: R- Right Angle 90°
④ Welding Way: S-SMT
⑤ Row No.-Pin No.: 2*XX-2*01P-2*12P
⑥ Plug the Pin & Special No.: A-With Post
⑦ Material: LP-LCP 94V-0
⑧ Planting Category: SN-Bright tin plating; SW-Matte Tin plating
⑨ Color: Blank-natural color

- Specifications:
- Voltage rating: 250V AC / DC
 - Current rating: 5A AC / DC
 - Withstanding voltage: 1000V AC/minute
 - Temperature range: -25°C~+85°C
 - Insulation resistance: >1000MΩ
 - Contact resistance: ≤10mΩ
 - After environmental testing: <20mΩ

For and on behalf of
KKB INDUSTRIAL PRECISION CO., LIMITED
 香港星坤工業精密有限公司

REVISIONS
 Authorized Signature(s)

MARK	DESCRIPTION	DATE	REVISED	APPROVED	UNSPECIFIED TOLERANCES
△ X					L > 63
△ X					16 < L ≤ 63
△ X					4 < L ≤ 16
△ X					L ≤ 4
					ANGULAR
					± 5°
					± 0.2
					± 0.3
					± 0.4
					± 0.5

REVISION	SHEET	WEIGHT	DATE	DATE	DATE	DATE	DATE	DATE
A0	1/1	1.0g						

KKB INDUSTRIAL PRECISION CO., LIMITED

DSND	SCALE: N/A	DATE	DATE	DATE	DATE	DATE	DATE
DWN	VIEW:	DATE	DATE	DATE	DATE	DATE	DATE
CHKD	UNIT: mm	DATE	DATE	DATE	DATE	DATE	DATE
APPD	SIZE: A4	DATE	DATE	DATE	DATE	DATE	DATE

MODEL TYPE: X3025WRS-2*XXC-XXXX
 PART NO.:
 DWG NO.:
 3.00 mm Crimp Style Connectors

PART NO	Material	Material(Pin)	Finish(Pin)	(Solder Tabs) Material	(Solder Tabs) Finish	Mates With XKB Housing
X3025WRS-2*XXC-LPSW	LCP UL 94V-0	Brass	Ni:50u"Min; Sn:120u"Min	Brass	Tin-Plated	X3025H
X3025WRS-2*XXC-LPSN	LCP UL 94V-0	Brass	Ni:50u"Min; Sn:120u"Min	Brass	Tin-Plated	
X3025WRS-2*XXC-NOSN	PA66 UL 94V-0	Brass	Ni:50u"Min; Sn:120u"Min	Brass	Finish Tabs	

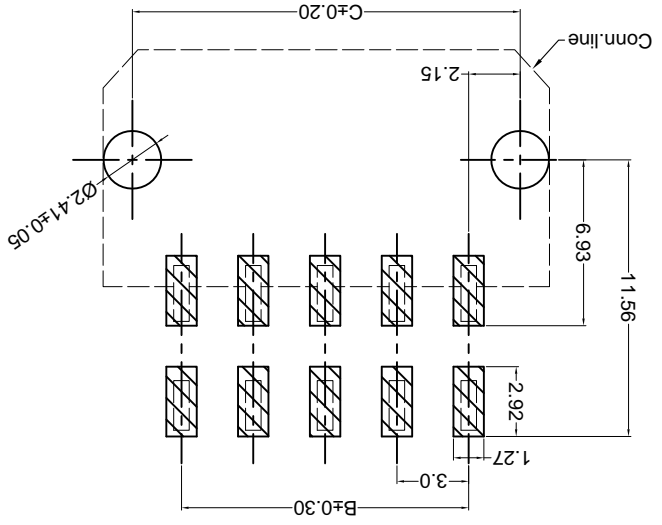
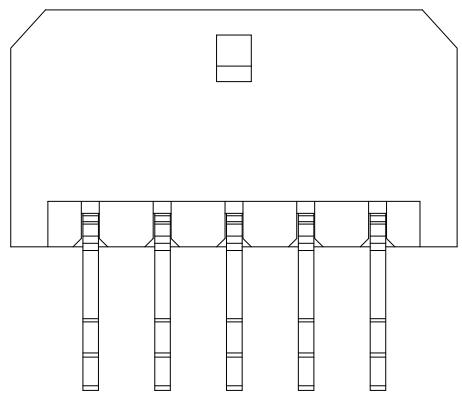
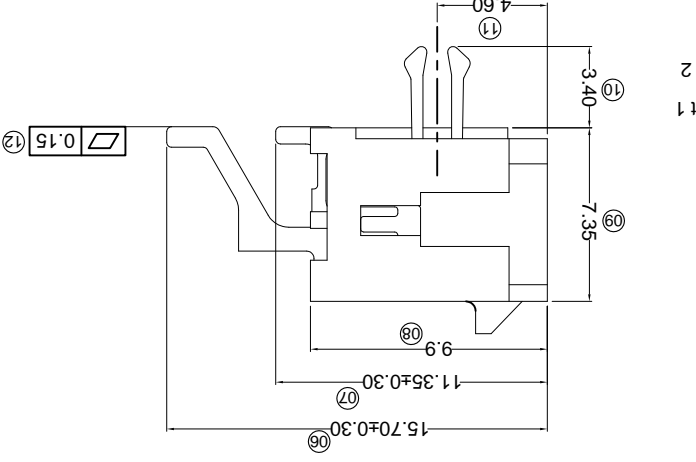
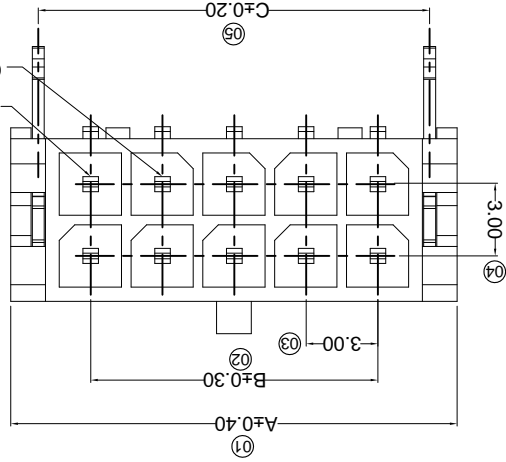

Poles	A	B	C
02	6.65	---	4.20
04	9.65	3.00	7.20
06	12.65	6.00	10.20
08	15.65	9.00	13.20
10	18.65	12.00	16.20
12	21.65	15.00	19.20
14	24.65	18.00	22.20
16	27.65	21.00	25.20
18	30.65	24.00	28.20
20	33.65	27.00	31.20
22	36.65	30.00	34.20
24	39.65	33.00	37.20

- **Specifications :**
- Voltage rating: 250V AC / DC
 - Current rating: 5A AC / DC
 - Withstanding voltage: 1000V AC/minute
 - Temperature range: -25°C~+85°C
 - Insulation resistance: ≥1000MΩ
 - Contact resistance: ≤10mΩ
 - After environmental testing: ≤20mΩ
- ① Series No.
 X3025 W R S-2*XX C-XX XX XX
- ② Category: W-water
 ③ Welding Board Angle: R-90°
 ④ Welding Way: S-SMT
 ⑤ Row No.-Pin No.: 2*XX-Double row
 ⑥ Special NO.: C-The harpoon
 ⑦ Material: LP-LCP 94V-0
 ⑧ Material: N0-PA66 94V-0
 ⑨ Plating Category:
 SN-Bright tin plating 70u"
 SW-Fog Tin plating
 Color: Blank-natural color

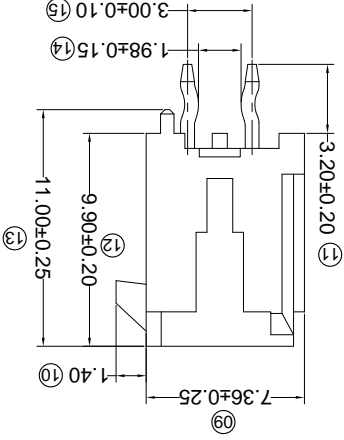
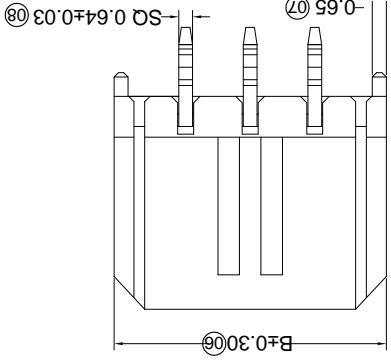
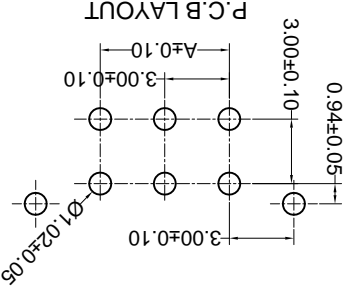
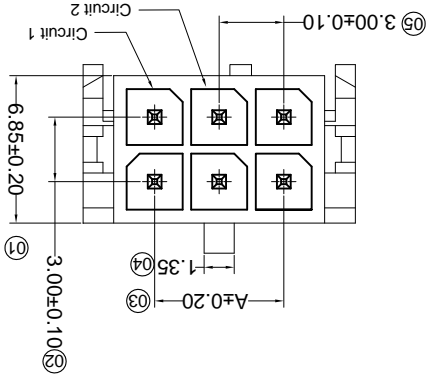

PART NO	Material	Material(Pin)	Finish(Pin)	Mates With XKB Housing
X3025WV-2*XX-46V01	PA46 UL 94V-0	Brass	Tin-Plated	X3025H
X3025WV-2*XX-LP5N	LC P UL 94V-0			
X025WV-2*XX-66B5N	PA66 UL 94V-0			
X3025WV-2*XX-46S5N	PA46 UL 94V-0			
X3025WV-2*XX-PT5N	PBT UL 94V-0			
X3025WV-2*XX-PT5N	PBT UL 94V-0			

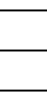
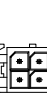
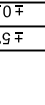
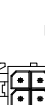
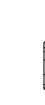
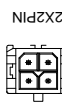
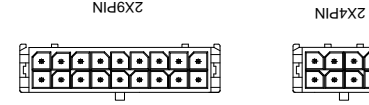
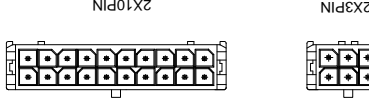
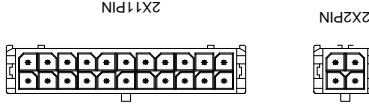
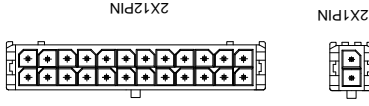
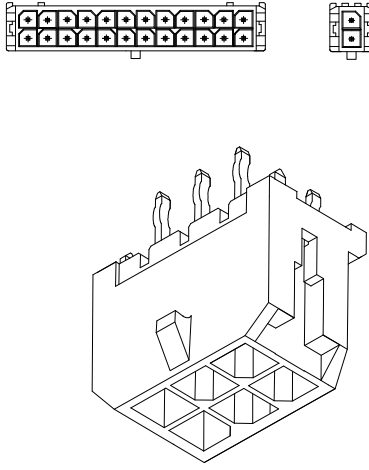

- Specifications :
- Voltage rating: 250V AC / DC
 - Current rating: 5A AC / DC
 - Withstanding voltage: 1000V AC/minute
 - Temperature range: -25°C~+85°C
 - Insulation resistance: ≥1000MΩ
 - Contact resistance: ≤10mΩ
 - After environmental testing: ≤20mΩ

X3025 W V X-2*XX X-XX XX XX ① ② ③ ④ ⑤ ⑥ ⑦ ⑧ ⑨

- Series No.
- Category: W-WAFER
- Welding Board Angle: V-Straight 180°
- Welding Way: Blank-DIP
- Row No.-Pin No.: 2*XX-2*01P~2*22P
- Plug the Pin & Special No.:
- Material: 66-PA66 94V-0; PT-PBT 94V-0; 46-PA46 94V-0 LP-LCP 94V-0
- Plating Category: SN-Bright Tin Plating; V01-All Gold Flash
- Color: Blank-Natural Color

Poles	Dimensions (mm)	
	A	B
2*01	---	6.65
2*02	3.00	9.65
2*03	6.00	12.65
2*04	9.00	15.65
2*05	12.00	18.65
2*06	15.00	21.65
Poles <th colspan="2">Dimensions (mm)</th>	Dimensions (mm)	
	A	B
2*01	18.00	24.65
2*02	21.00	27.65
2*03	24.00	30.65
2*04	27.00	33.65
2*05	30.00	36.65
2*06	33.00	39.65

For and on behalf of
XKB INDUSTRIAL PRECISION CO., LIMITED

香港星坤工業精密有限公司

Authorized Signature(s)

MARK	DESCRIPTION	DATE	REVISED	APPROVED	UNSPECIFIED TOLERANCES
△ X					L > 63 ±0.5
△ X					16 < L ≤ 63 ±0.4
△ X					4 < L ≤ 16 ±0.3
					L ≤ 4 ±0.2
					ANGULAR ±5°

DSND	DATE	SCALE: N/A	MODEL TYPE: X3025WV-2*XX-XXXX
DWN	DATE <td>VIEW: ②</td> <td>PART NO.:</td>	VIEW: ②	PART NO.:
CHKD	DATE <td>UNIT: mm</td> <td>DWG NO.:</td>	UNIT: mm	DWG NO.:
APPD	DATE <td>SIZE: A4</td> <td>REVISION</td>	SIZE: A4	REVISION
		WEIGHT	1.0g
		SHEET	1/1
		REVISION	A0

XKB INDUSTRIAL PRECISION CO., LIMITED

For and on behalf of
KXB INDUSTRIAL PRECISION CO., LIMITED
 香港星坤工業精密有限公司

Authorized Signatures

MARK	DESCRIPTION	DATE	REVISED	APPROVED	UNSPECIFIED TOLERANCES
△ X					L > 63
△ X					16 > L ≤ 63
△ X					4 < L ≤ 16
△ X					L ≤ 4
					ANGULAR
					± 5°

REVISIONS	DATE	REVISED	APPROVED	UNSPECIFIED TOLERANCES
				L > 63
				16 > L ≤ 63
				4 < L ≤ 16
				L ≤ 4
				ANGULAR
				± 5°

MODEL TYPE:	SCALE: N/A	DATE:	DNSD
X3025WV-2*XXC-XXC-XXXX			

PART NO:	VIEW:	DATE:	DWN
300 mm Crimp Style Connectors			

DMG NO.:	UNIT: mm	DATE:	CHKD

WEIGHT	SHEET	REVISION	APPD
1.0g	1/1	A0	

SIZE: A4	DATE:	DATE:	DATE:

PART NO	Material	Material(Pin)	Finish(Pin)	Mates With
X3025WV-2*XXC-N0SN	Nylon 9T UL 94V-0	Brass	Tin Plating Fog	X3025H
X3025WV-2*XXC-LPSW	LCP UL 94V-0			

Poles	Dimensions (mm)
A	39.65
B	36.65
	33.00
	30.00
	27.00
	24.00
	21.00
	18.00
	15.00
	12.00
	9.00
	6.00
	3.00
	0.94

- ① Series No.
- ② Category:
- ③ W-water
- ④ Welding Board Angle:
- ⑤ V-180°
- ⑥ Welding Way:
- ⑦ Blank-DIP
- ⑧ Row No.-Pin No.
- ⑨ 2*XX-Double row
- ⑩ Special NO.
- ⑪ C-The harpoon
- ⑫ Material:
- ⑬ LP-LCP 94V-0 N0-PA9T 94V-0
- ⑭ Planting Category:
- ⑮ V**All Gold-Plated
- ⑯ *01-Gold Flash : *02-2u" ; *03-3u" ; *05-5u"
- ⑰ *10-10u" ; *15-15u" ; *30-30u" ; *50-50u"
- ⑱ SN-Bright tin plating 70u"
- ⑲ SN1-Bright tin plating 120u"Min. ;
- ⑳ SW-Fog Tin plating
- ㉑ Color:
- ㉒ Blank-natural color

X3025 W V X-2*XX C-XX XX XX
 ① ② ③ ④ ⑤ ⑥ ⑦ ⑧ ⑨ ⑩ ⑪ ⑫ ⑬ ⑭ ⑮ ⑯ ⑰ ⑱ ⑲ ⑳ ㉑ ㉒

- Specifications :
- Voltage rating: 250V AC / DC
- Current rating: 5A AC / DC
- Withstanding voltage: 1000V AC/minute
- Temperature range: -25°C~+85°C
- Insulation resistance: ≥1000MΩ
- Contact resistance: ≤10mΩ
- After environmental testing: ≤20mΩ

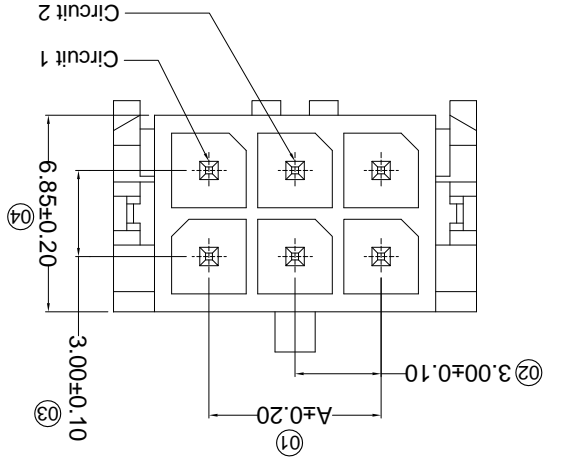
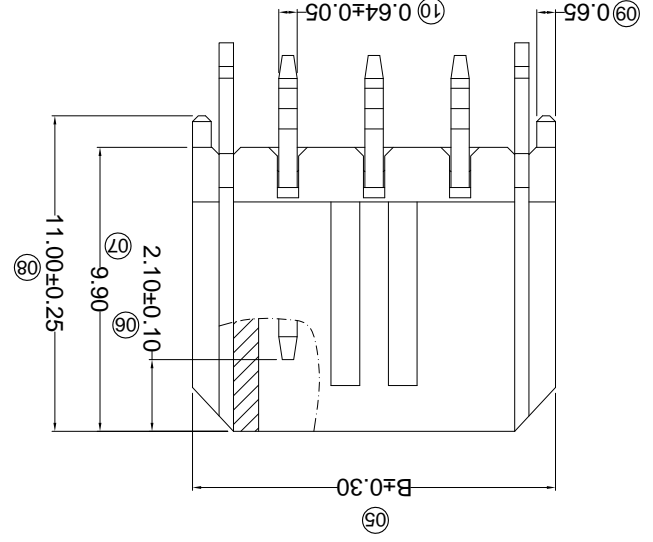
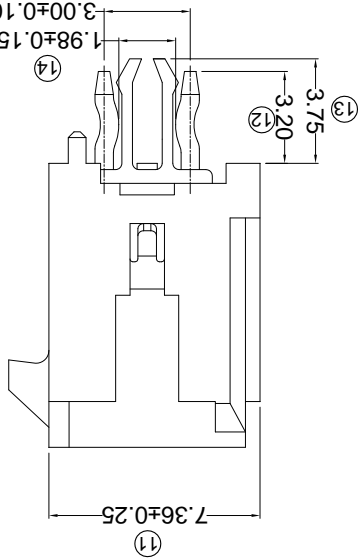

P.C.B LAYOUT

REVISIONS
Authorized Signatures

MARK	DESCRIPTION	DATE	REVISED	APPROVED	UNSPECIFIED TOLERANCES
△ X					L > 63
△ X					16 < L ≤ 63
△ X					4 < L ≤ 16
△ X					L ≤ 4
					ANGULAR
					± 5°

For and on behalf of
XKB INDUSTRIAL PRECISION CO., LIMITED
香港星坤工業精密有限公司

XKB INDUSTRIAL PRECISION CO., LIMITED

WEIGHT	1.0g
SHEET	1/1
REVISION	A0
SIZE:	A4
DATE:	
UNIT:	mm
VIEW:	①
SCALE:	N/A
MODEL TYPE:	X3025WV-2*XXCN-LPSN
PART NO.:	
DWG NO.:	

PART NO	Material	Material(Pin)	Finish(Pin)	Mates With XKB Housing
X3025WV-2*XXCN-LPSN	LCP UL 94V-0	Brass	Tin-Plated	X3025H

Poles	A	B
02	--	6.65
04	3.00	9.65
06	6.00	12.65
08	9.00	15.65
10	12.00	18.65
12	15.00	21.65
14	18.00	24.65
16	21.00	27.65
18	24.00	30.65
20	27.00	33.65
22	30.00	36.65
24	33.00	39.65

- ① Series No.
- ② Category:
- ③ W-water
- ④ Welding Board Angle:
- ⑤ V-180°
- ⑥ Welding Way:
- ⑦ Blank-DIP
- ⑧ Row No.-Pin No.
- ⑨ 2*XX-Double row
- ⑩ Special NO.
- ⑪ C-The harpoon N-without K the feet
- ⑫ Material:
- ⑬ LP-LCP 94V-0
- ⑭ Planting Category:
- ⑮ V**All Gold-Plated
- ⑯ *01-Gold Flash ; *02-2u" ; *03-3u" ; *05-5u"
- ⑰ *10-10u" ; *15-15u" ; *30-30u" ; *50-50u"
- ⑱ SN-Bright tin plating 70u"
- ⑲ SN1-Bright tin plating 120u"Min.
- ⑳ SW-Fog Tin plating
- ㉑ Color:
- ㉒ Blank-natural color

- Specifications :**
- Voltage rating: 250V AC / DC
 - Current rating: 5A AC / DC
 - Withstanding voltage: 1000V AC/minute
 - Temperature range: -25°C~+85°C
 - Insulation resistance: ≥1000MΩ
 - Contact resistance: ≤10mΩ
 - After environmental testing: ≤20mΩ

P.C.B LAYOUT

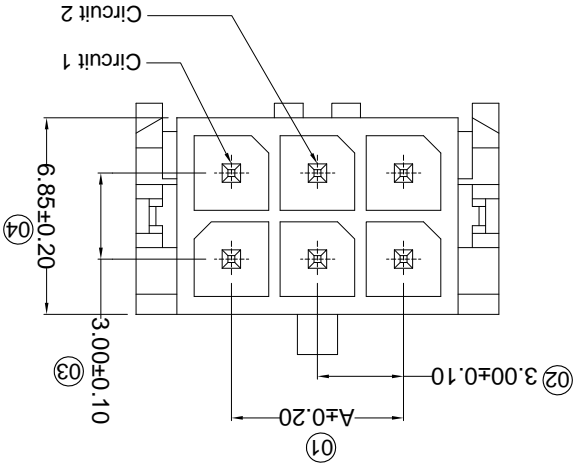
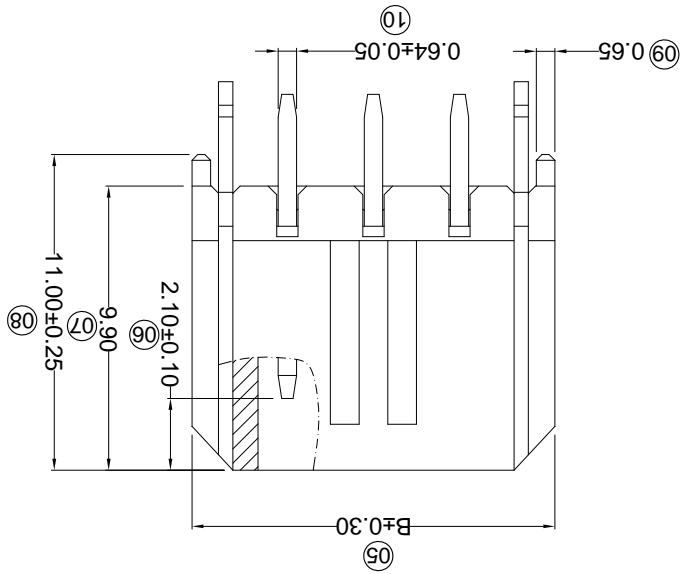
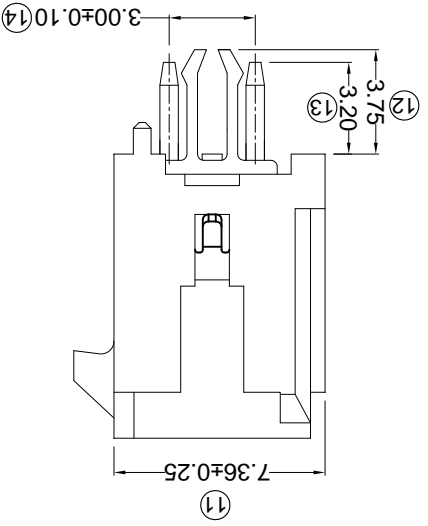
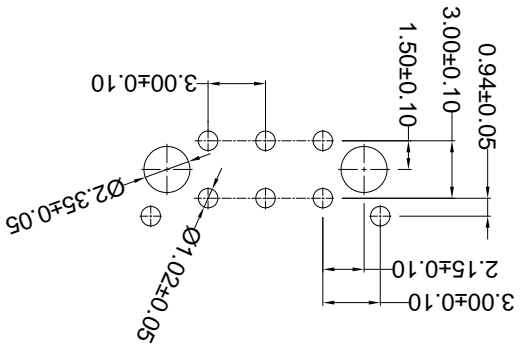

For and on behalf of
KXB INDUSTRIAL PRECISION CO., LIMITED
 香港星坤工業精密有限公司

Authorized Signatures

MARK	DESCRIPTION	DATE	REVISIONS	APPROVED	REVISOR	DATE
△ X						
△ X						
△ X						

UNSPECIFIED TOLERANCES
L > 63 ± 0.5
16 < L ≤ 63 ± 0.4
4 < L ≤ 16 ± 0.3
L ≤ 4 ± 0.2
ANGULAR ± 5°

REVISION	SHEET	WEIGHT	DATE	DATE	DATE	DATE	DATE	DATE
A0	1/1	1.0g						

Part No.	Material	Material(Pin)	Finish(Pin)	Tin-Plated	Part No.	Material	Material(Pin)	Finish(Pin)	Tin-Plated
X3025WV-2*XXH-LPSN	LCP UL 94V-0	Brass			X3025H				

Dimensions (mm)	A	B	C
04	3.00	13.00	12.00
06	6.00	16.00	15.00
08	9.00	19.00	18.00
10	12.00	22.00	21.00
12	15.00	25.00	24.00
14	18.00	28.00	27.00
16	21.00	31.00	30.00
18	24.00	34.00	33.00
20	27.00	37.00	36.00
22	30.00	40.00	39.00
24	33.00	43.00	42.00

- ① Series No.
- ② Category: W-water
- ③ Welding Board Angle: V-180°
- ④ Welding Way: Blank-DIP
- ⑤ Row No.-Pin No.
- ⑥ 2*XX-Double row
- ⑦ Special NO.
- ⑧ H-Arrange ushering with positioning column
- ⑦ Material: LP-LCP 94V-0
- ⑧ Planting Category: V**All Gold-Plated
- ⑧ G**Gold-Plated Contact
- ⑧ *01-Gold Flash ; *02-2u" ; *03-3u" ; *05-5u"
- ⑧ *10-10u" ; *15-15u" ; *30-30u" ; *50-50u"
- ⑧ SN-Bright tin plating 70u"
- ⑧ SN1-Bright tin plating 120u"Min. ;
- ⑧ SW-Fog Tin plating
- ⑧ Color: Blank-natural color

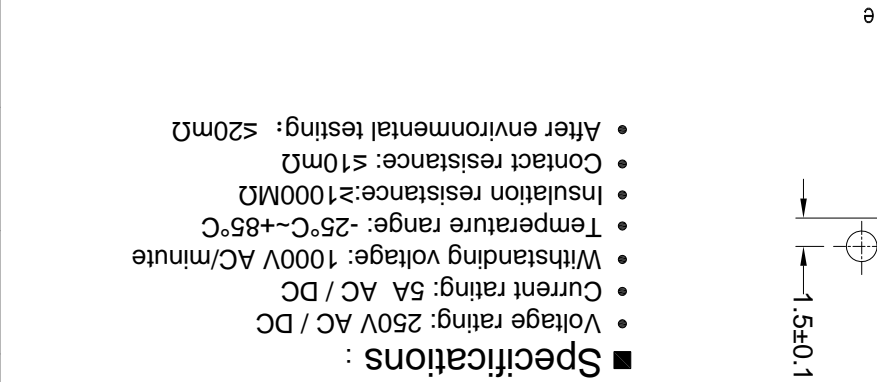

- Specifications :
- Voltage rating: 250V AC / DC
 - Current rating: 5A AC / DC
 - Withstanding voltage: 1000V AC/minute
 - Temperature range: -25°C~+85°C
 - Insulation resistance: ≥1000MΩ
 - Contact resistance: ≤10mΩ
 - After environmental testing: ≤20mΩ

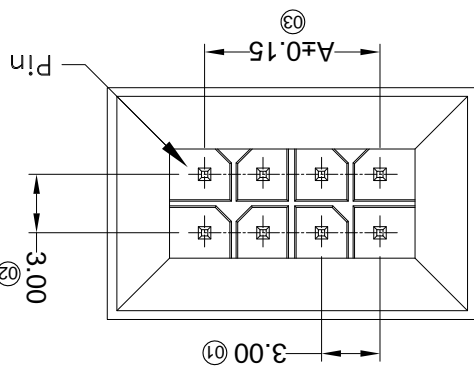
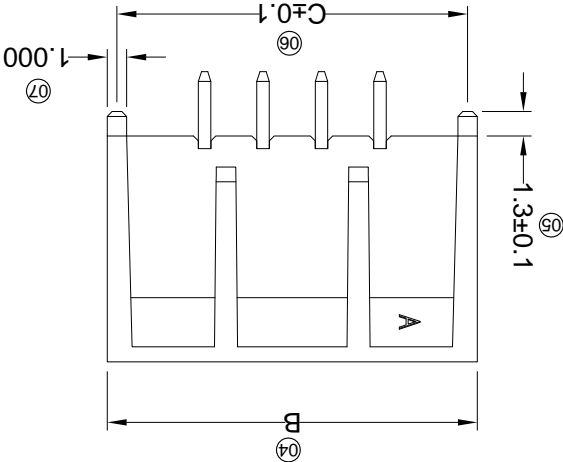
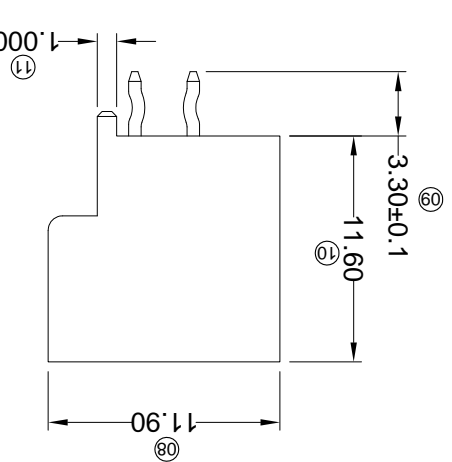

REVISIONS
 (Authorized Signatures)

MARK	DESCRIPTION	DATE	REVISED	APPROVED	UNSPECIFIED TOLERANCES
△ X					L > 63
△ X					16 < L ≤ 63
△ X					4 < L ≤ 16
△ X					L ≤ 4
					ANGULAR
					± 5°

For and on behalf of
XKB INDUSTRIAL PRECISION CO., LIMITED
 香港星坤工業精密有限公司

XKB INDUSTRIAL PRECISION CO., LIMITED

WEIGHT	1.0g
SHEET	1/1
REVISION	A0
SIZE:	A4
DATE:	
UNIT:	mm
VIEW:	
SCALE:	N/A
MODEL TYPE:	X3025WVS-2*XXC-LPXX
PART NO.:	
3.00 mm Crimp Style Connectors	
DWG NO.:	

Recommended P.C.B Layout
 General Tolerance±0.05

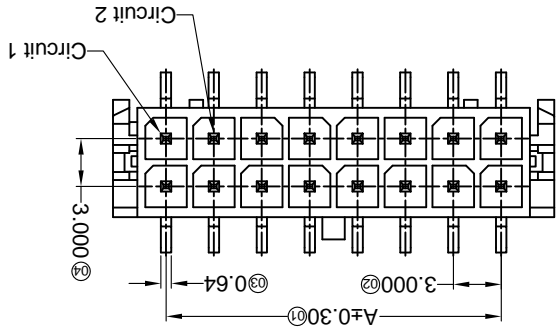
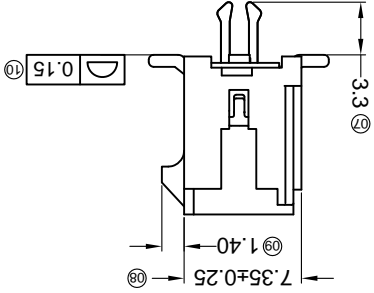
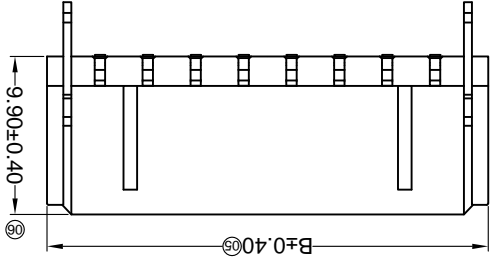
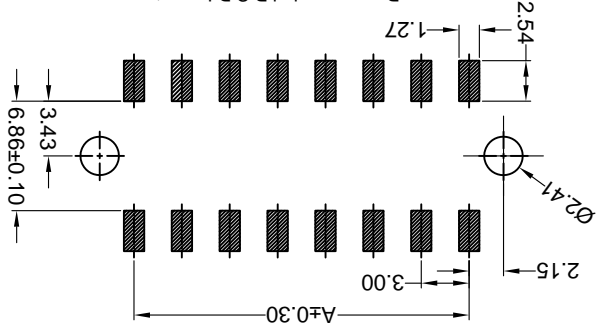

PART NO	Material	Material (Pn)	Finish (Pn)	Material (Pn)	Material (Pn)	Material (Pn)	Material (Pn)
X3025WVS-2*XXC-LPXX	LCP UL 94V-0	Brass	Tin-Plated	Brass	Tin-Plated	Brass	Tin-Plated
X3025WVS-2*XXC-LPXX	LCP UL 94V-0	Brass	Tin-Plated	Brass	Tin-Plated	Brass	Tin-Plated

Poles	Dimensions(mm)	A	B
2*01	---	6.65	2*07
2*02	3.00	9.65	2*08
2*03	6.00	12.65	2*09
2*04	9.00	15.65	2*10
2*05	12.00	18.65	2*11
2*06	15.00	21.65	2*12

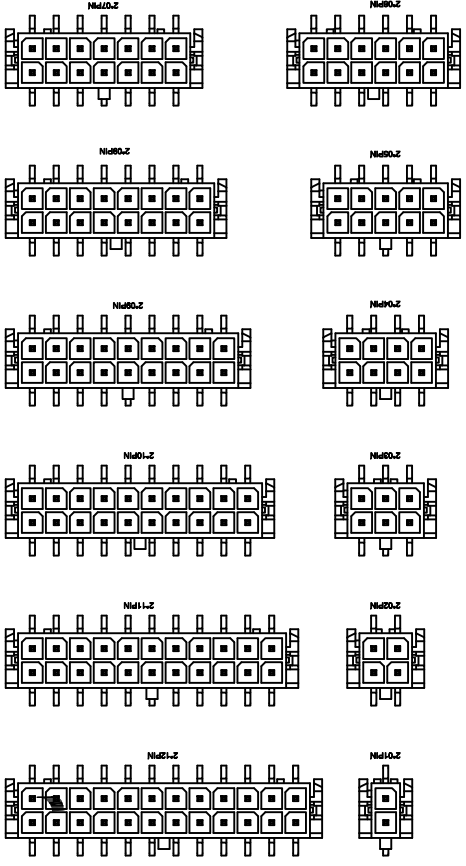

- ① Series No.
- ② Category: W-water
- ③ Welding Board Angle: V- Straight 180°
- ④ Welding Way: S-SMT
- ⑤ Row No-Pin No.: 2*XX-2*01P~2*12P
- ⑥ Plug the Pin & Special No.: C-The Harpoon
- ⑦ Material: LP-LCP 94V-0
- ⑧ Plating Category: SN-Bright tin plating ; SW-Matte Tin plating
- ⑨ Color: Blank-Natural color

X3025 W V S-2*XX C-LP XX XX

- Specifications :**
- Voltage rating: 250V AC / DC
 - Current rating: 5A AC / DC
 - Withstanding voltage: 1000V AC/minute
 - Temperature range: -25°C~+85°C
 - Insulation resistance: ≥1000MΩ
 - Contact resistance: ≤10mΩ
 - After environmental testing: ≤20mΩ

REVISIONS
Authorized Signature(s)

MARK	DESCRIPTION	DATE	REVISED	APPROVED	UNSPECIFIED TOLERANCES
△ X					L > 63
△ X					16 > L ≤ 63
△ X					4 < L ≤ 16
					L ≤ 4
					ANGULAR
					± 5°

For and on behalf of
XKB INDUSTRIAL PRECISION CO., LIMITED
 香港星坤工業精密有限公司

XKB INDUSTRIAL PRECISION CO., LIMITED

WEIGHT	1.0g
SHEET	1/1
REVISION	A0
SIZE:	A4
UNIT:	mm
VIEW:	
SCALE:	N/A
MODEL TYPE:	X3025WVS-2*XXD-LPSW
PART NO.:	
DWG NO.:	3.00 mm Crimp Style Connectors

P.C.B. LAYOUT

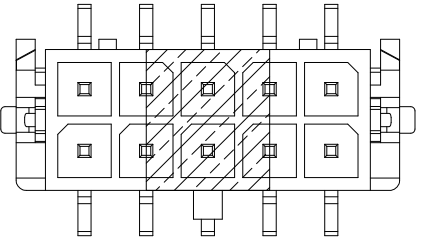
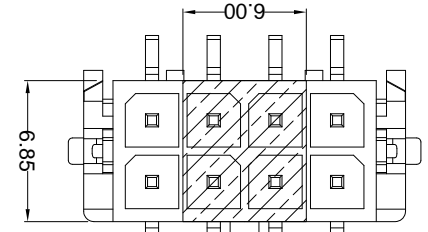
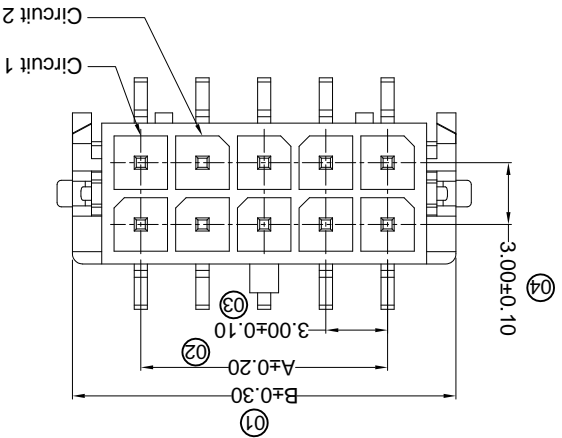
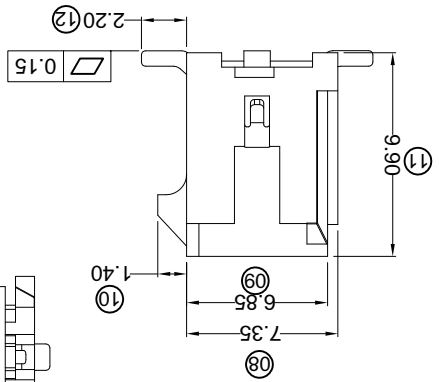
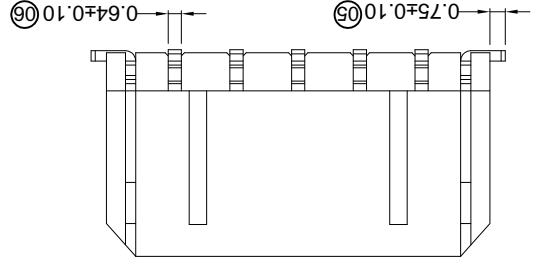
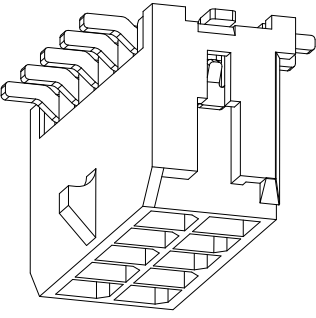
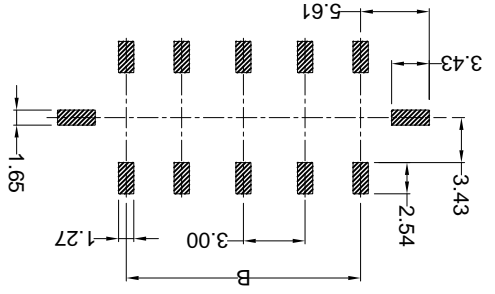

PART NO	Material	Material(Pin)	Finish(Pin)	Material (Solder Tabs)	Finish (Solder Tabs)	Material (Solder Tabs)	Finish (Solder Tabs)	Dimensions(mm)	
								A	B
X3025WVS-2*XXD-LPSW	LCP UL 94V-0	Brass	Matte tin	Brass	Matte tin	Matte tin	Matte tin	A	B
2*06		15.00	2*12	21.65	2*12	33.00	39.65		
2*05		12.00	2*11	18.65	2*11	30.00	36.65		
2*04		9.00	2*10	15.65	2*10	27.00	33.65		
2*03		6.00	2*09	12.65	2*09	24.00	30.65		
2*02		3.00	2*08	9.65	2*08	21.00	27.65		
2*01		---	2*07	6.65	2*07	18.00	24.65		
						A	B		

- ① Series No.
- ② Category: W-water
- ③ Weiding Board Angle: V- Stright 180°
- ④ Weiding Way: S-SMT
- ⑤ Row No.-Pin No.: 2*XX-2*01P-2*12P
- ⑥ Plug the Pin & Special No.: D-Solder Tabs
- ⑦ Material: LP-LCP 94V-0
- ⑧ Planting Category:
- ⑨ SN-Bright tin plating ; SW-Matte Tin plating
- ⑩ Color: Blank-Natural color

X3025 W V S-2*XX D-LP XX XX

- Voltage rating: 250V AC / DC
- Current rating: 5A AC / DC
- Withstanding voltage: 1000V AC/minute
- Temperature range: -25°C~+85°C
- Insulation resistance: ≥1000MΩ
- Contact resistance: ≤10mΩ
- After environmental testing: ≤20mΩ

■ Specifications :

X-ON Electronics

Largest Supplier of Electrical and Electronic Components

Click to view similar products for [Headers & Wire Housings](#) category:

Click to view products by [XKB](#) manufacturer:

Other Similar products are found below :

[95000-104TRLF](#) [10135584-644402LF](#) [DF62W-EP2022PCA](#) [95000-106TRLF](#) [DF62W-2022SCA](#) [DF62W-EP2022PC](#) [2203348](#) [DF62W-2022SC](#) [1084018](#) [1029039](#) [1084017](#) [802-10-012-10-002000](#) [1112640](#) [1112639](#) [891-007-9SS-BST1T](#) [000-34000](#) [0008550134](#) [0009482033](#) [0009507031](#) [57102-F02-18ULF](#) [57102-S06-03LF](#) [57202-S52-04LF](#) [PCN6-15S-2.5E](#) [0039019024](#) [58102-G61-06LF](#) [582553-1](#) [0009485154](#) [0009508121](#) [0022285053](#) [0050291907](#) [018731A](#) [LY20-4P-DT1-P1E-BR](#) [02.125.8002.8](#) [60101931](#) [60598-1 \(Cut Strip\)](#) [M1625-3R/100](#) [61062-3](#) [61082-181009](#) [CSU011177004](#) [636-1427](#) [638009-1](#) [641938-9](#) [641991-4](#) [644168-1](#) [644827-2](#) [647662-1](#) [65039-019ELF](#) [65692-001LF](#) [65781-018](#) [65781-047](#)