

RoHS
Lead-free

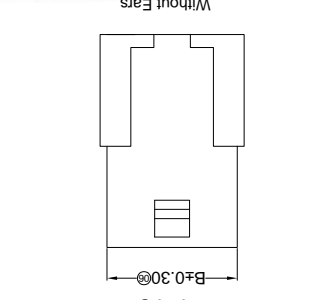

Without Ears

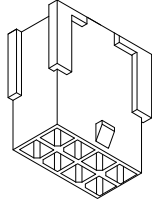
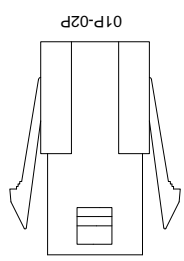
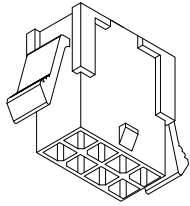
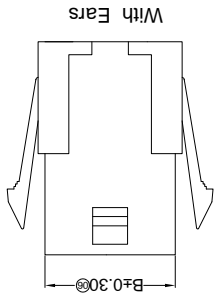
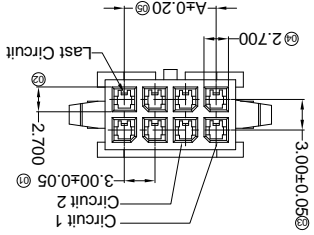
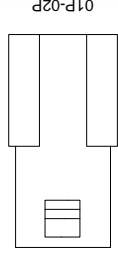

01P-02P

For and on behalf of
XKB INDUSTRIAL PRECISION CO., LIMITED
香港星坤工業精密有限公司

MARK	DESCRIPTION	DATE	REVISED	APPROVED	UNSPECIFIED TOLERANCES
△ X					L > 63 ±0.5
△ X					16 < L ≤ 63 ±0.4
△ X					4 < L ≤ 16 ±0.3
					L ≤ 4 ±0.2
					ANGULAR ±5°

REVISIONS
Authorized Signature(s)

PART NO	Material	Suitable SWB Terminal	Mates With XKB Housing	Note
X3025HF-2*XXG-N2	Nylon 66 94V-2	X3025TM	X3025HM	With Ears
X3025HF-2*XXI-N2	Nylon 66 94V-2	X3025TM		Without Ears

Poles	Dimensions(mm)		Poles	Dimensions(mm)	
	A	B		A	B
2*01	18.00	22.00	2*07	4.00	2.00
2*02	3.00	7.00	2*08	7.00	25.00
2*03	6.00	10.00	2*09	10.00	28.00
2*04	9.00	13.00	2*10	13.00	31.00
2*05	12.00	16.00	2*11	16.00	34.00
2*06	15.00	19.00	2*12	19.00	37.00

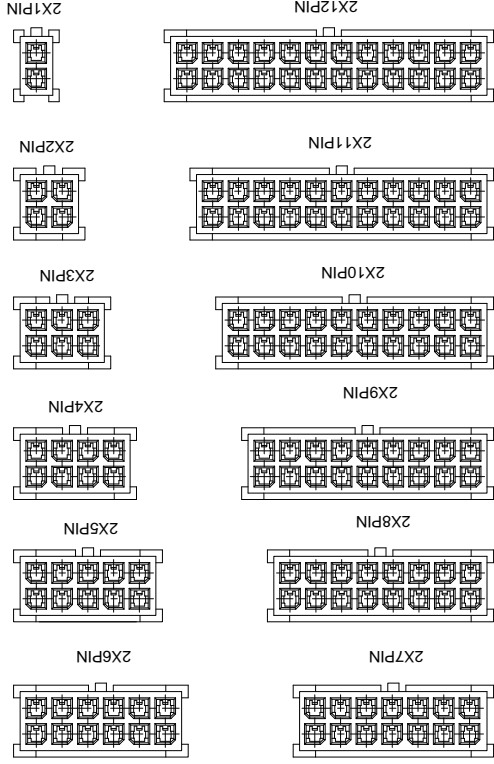

X3025 H F-2*XX XX-N2 XX

① Series No.

② Category: H-HSG

③ Welding Board Angle: F-Female HSG

④ Row No.-Pin No.: 2*XX-2*01P-2*12P

⑤ Plug the Pin & special No.: I-Without Ears

⑥ Material: N2-PA66 94V-2;

⑦ Color: Blank-Natural Color

- Voltage rating: 250V AC / DC
- Current rating: 5A AC / DC
- Withstanding voltage: 1000V AC/minute
- Temperature range: -25°C~+85°C
- Insulation resistance: ≥1000MΩ
- Contact resistance: ≤10mΩ
- After environmental testing: ≤20mΩ

■ Specifications :

DSND	DATE	SCALE: N/A	MODEL TYPE: X3025HF-2*XX-N2
DWN	DATE	VIEW:	PART NO.:
CHKD	DATE	UNIT: mm	3.00 mm Crimp Style Connectors
APPD	DATE	SIZE: A4	DWG NO.:
		WEIGHT	1.0g
		SHEET	1/1
		REVISION	A0

XKB INDUSTRIAL PRECISION CO., LIMITED

DSND	DATE	SCALE: N/A	MODEL TYPE: X3025HF-2*XX-N2
DWN	DATE	VIEW:	PART NO.:
CHKD	DATE	UNIT: mm	3.00 mm Crimp Style Connectors
APPD	DATE	SIZE: A4	DWG NO.:
		WEIGHT	1.0g
		SHEET	1/1
		REVISION	A0

XKB INDUSTRIAL PRECISION CO., LIMITED

Authorized Signatures

For and on behalf of
KXB INDUSTRIAL PRECISION CO., LIMITED
 香港星坤工業精密有限公司

MARK	DESCRIPTION	DATE	REVISIONS	APPROVED	REVISOR	DATE
△ X						
△ X						
△ X						

UNSPECIFIED TOLERANCES	APPROVED	REVISOR	DATE	APPD	CHKD	DWN	DSND
L > 63							
16 < L ≤ 63							
4 < L ≤ 16							
L ≤ 4							
ANGULAR							

DATE	SCALE: N/A	MODEL TYPE: X3025HM-2*XX-N2	VIEW:	UNIT: mm	SIZE: A4

WEIGHT	SHEET	REVISION
1.0g	1/1	A0

PART NO	Material	Suitable SWB Terminal	Mates With XKB Water
X3025HM-2*XX-N2	Nylon 66 94V-2	X3025TF	X3025W

Poles	Dimensions(mm)		Poles	Dimensions(mm)	
	A	B		A	B
2*01	2*07	18.00	2*01	2*07	18.00
2*02	3.00	24.00	2*02	2*08	24.85
2*03	6.00	27.85	2*03	2*09	27.85
2*04	9.00	30.85	2*04	2*10	30.85
2*05	12.00	33.85	2*05	2*11	33.85
2*06	15.00	36.85	2*06	2*12	36.85

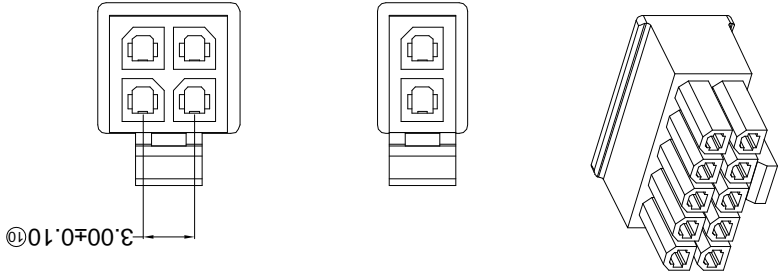
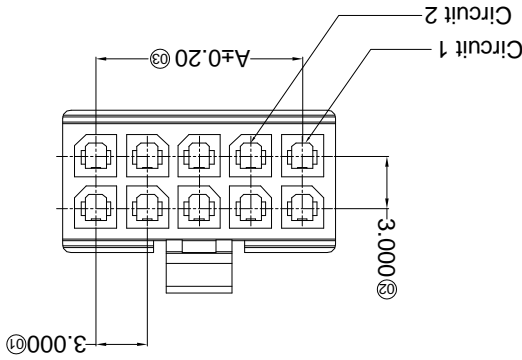
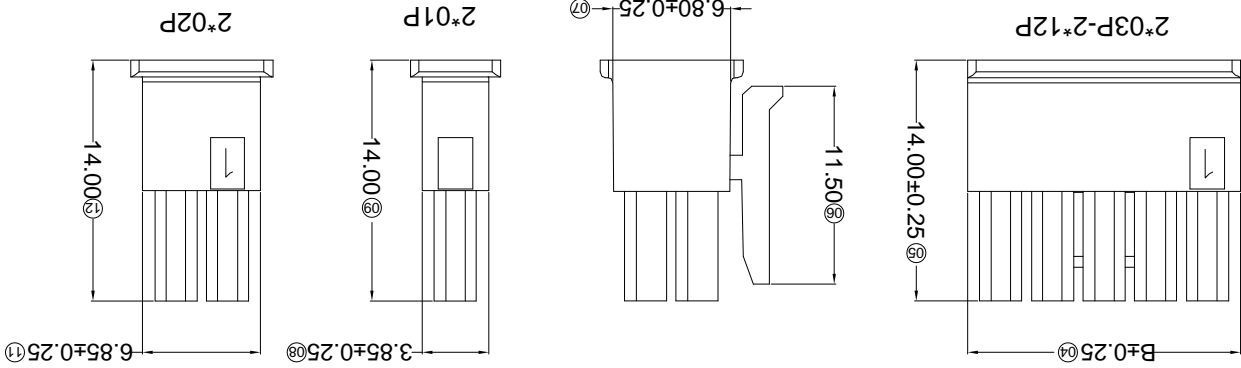
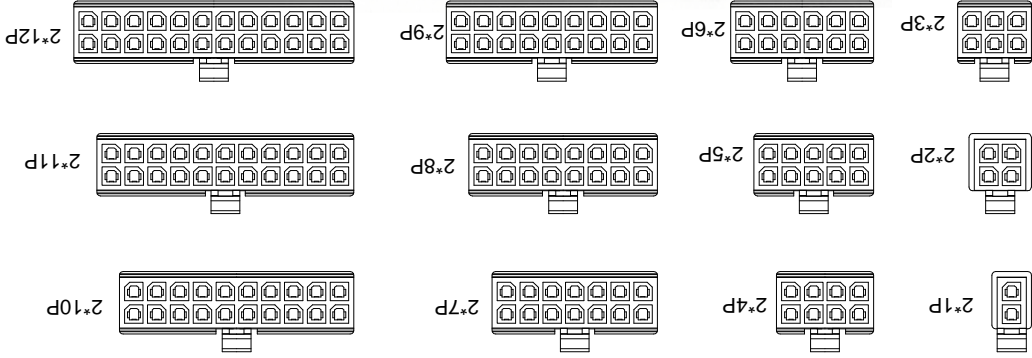

X3025 H M-2*XX XX-N2 XX

① Series No.

② Category: H-HSG

③ Welding Board Angle: M-Male HSG

④ Row No.-Pin No.: 2*XX-2*01P~2*12P

⑤ Plug the Pin & special No.:

⑥ Material: N2-PA66 94V-2;

⑦ Color: Blank-Natural Color

- Specifications:
- Voltage rating: 250V AC / DC
 - Current rating: 5A AC / DC
 - Withstanding voltage: 1000V AC/minute
 - Temperature range: -25°C~+85°C
 - Insulation resistance: ≥1000MΩ
 - Contact resistance: ≤10mΩ
 - After environmental testing: ≤20mΩ

REVISIONS
Authorized Signature(s)

MARK	DESCRIPTION	DATE	REVISED	APPROVED	UNSPECIFIED TOLERANCES
△ X					L > 63 ± 0.5
△ X					16 < L ≤ 63 ± 0.4
△ X					4 < L ≤ 16 ± 0.3
△ X					L ≤ 4 ± 0.2
					ANGULAR ± 5°

For and on behalf of
XKB INDUSTRIAL PRECISION CO., LIMITED
香港星坤工業精密有限公司

XKB INDUSTRIAL PRECISION CO., LIMITED

WEIGHT	1.0g	REVISION	A0
SHEET	1/1		
SIZE:	A4	DATE	
UNIT:	mm	DATE	
VIEW:		DATE	
SCALE:	N/A	DATE	
MODEL TYPE:	X3025HR-2*XX-LPSN		
PART NO.:			
3.00 mm Crimp Style Connectors			
DWG NO.:			

Part No.	Material	Material(Pin)	Finish(Pin)	Mates With XKB Housing
X3025HR-2*XX-LPSN	LCP UL 94V-0	Brass	Tin-Plated	X3025HW or 3025H

Poles	Dimensions(mm)		
	A	B	C
2'02	3.00	6.70	2'08
2'03	6.00	9.70	2'09
2'04	9.00	12.70	2'10
2'05	12.00	15.70	2'11
2'06	15.00	18.70	2'12
2'07	18.00	21.70	15.00

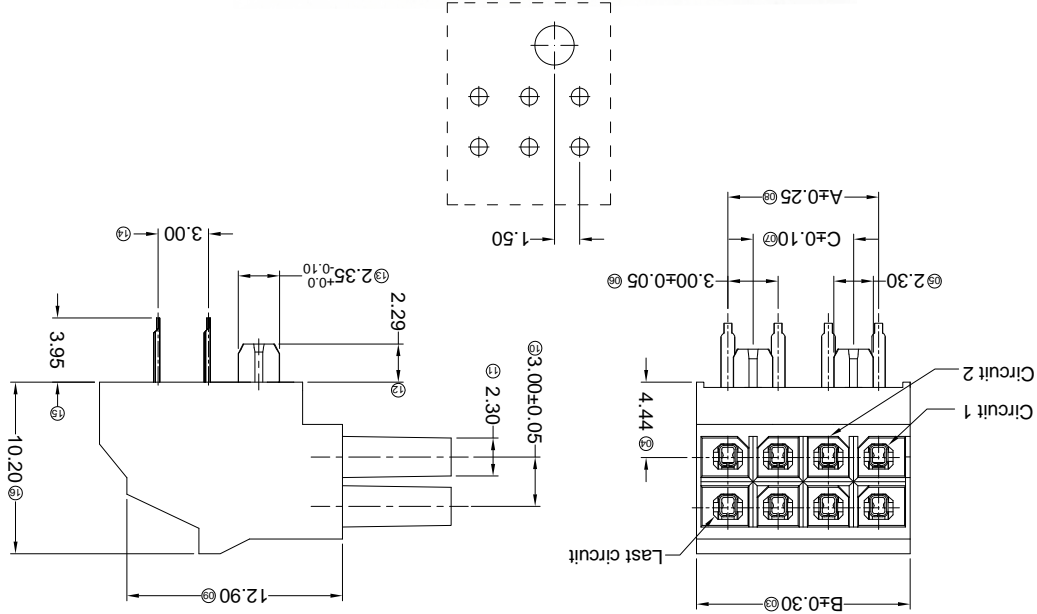

- ① Series No.
- ② Category: H-HSG
- ③ Welding Board Angle: BOARD-IN-R-90°
- ④ Row No.-Pin No.: 2*XX-2*02P~2*12P
- ⑤ Plug the Pin & special No.:
- ⑥ Material: LP-LCP 94V-0;
- ⑦ Plating Category: SN-Bright tin plating
- ⑧ Color: Blank-Natural Color

X3025 H R-2*XX LP SN XX
① ② ③ ④ ⑤ ⑥ ⑦ ⑧

- Specifications :
- Voltage rating: 250V AC / DC
 - Current rating: 5A AC / DC
 - Withstanding voltage: 1000V AC/minute
 - Temperature range: -25°C~+85°C
 - Insulation resistance: ≥1000MΩ
 - Contact resistance: ≤10mΩ
 - After environmental testing: ≤20mΩ

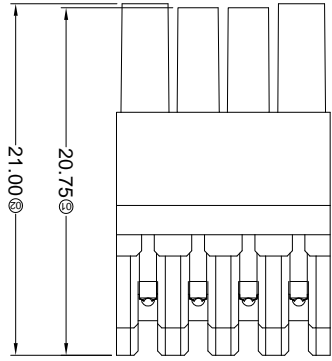
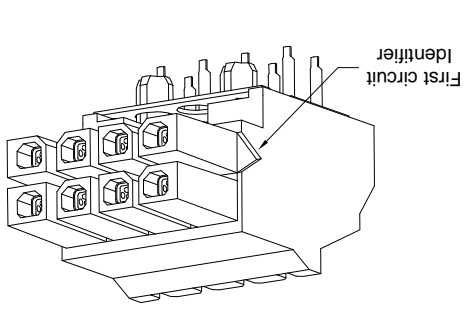
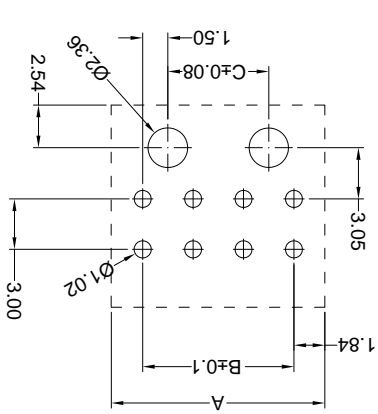

For and on behalf of
KRB INDUSTRIAL PRECISION CO., LIMITED
 香港星坤工業精密有限公司

MARK	DESCRIPTION	DATE	REVISIONS	UNSPECIFIED TOLERANCES
△ X				±0.5
△ X				16 < L ≤ 63
△ X				L ≤ 4
△ X				ANGULAR ±5°

MARK	DESCRIPTION	DATE	REVISIONS	UNSPECIFIED TOLERANCES
△ X				±0.5
△ X				16 < L ≤ 63
△ X				L ≤ 4
△ X				ANGULAR ±5°

DSND	DATE	SCALE: N/A	MODEL TYPE: X3025HV-2*XX-LPSN
DWN	DATE	VIEW:	PART NO.: 3.00 mm Crimp Style Connectors
CHKD	DATE	UNIT: mm	DWG NO.:
APPD	DATE	SIZE: A4	WEIGHT 1.0g
			SHEET 1/1
			REVISION A0

Part No.	Material	Material(Pin)	Finish(Pin)	Mates With KRB Housing
X3025HV-2*XX-LPSN	LCP UL 94V-0	Brass	Tin-Plated	X3025HW or 3025H

Poles	Dimensions(mm)			
	A	B	C	D
2*02	3.00	6.85	12.00	9.00
2*03	6.00	9.85	15.00	12.00
2*04	9.00	12.85	18.00	15.00
2*05	12.00	15.85	21.00	18.00
2*06	15.00	18.85	24.00	21.00
2*07	18.00	21.85	27.00	24.00
2*08	21.00	24.85	30.00	27.00
2*09	24.00	27.85	33.00	30.00
2*10	27.00	30.85	36.00	33.00
2*11	30.00	33.85	39.00	36.00
2*12	33.00	36.85	42.00	39.00

- ① Series No.
- ② Category: H-HSG
- ③ Welding Board Angle: BOARD-IN: V-180°
- ④ Row No.-Pin No.: 2*XX-2*02P~2*12P
- ⑤ Plug the Pin & special No.:
- ⑥ Material: LP-LCP 94V-0;
- ⑦ Plating Category: SN-Bright tin plating
- ⑧ Color: Blank-Natural Color

X3025 H V-2*XX-LP SN XX

- Specifications :
- Voltage rating: 250V AC / DC
 - Current rating: 5A AC / DC
 - Withstanding voltage: 1000V AC/minute
 - Temperature range: -25°C~+85°C
 - Insulation resistance: ≥1000MΩ
 - Contact resistance: ≤10mΩ
 - After environmental testing: ≤20mΩ

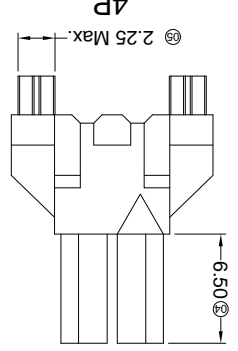
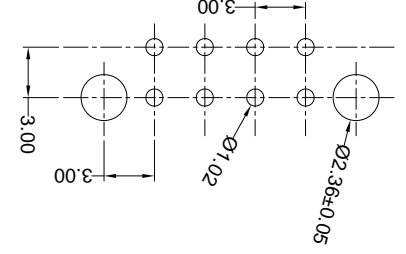
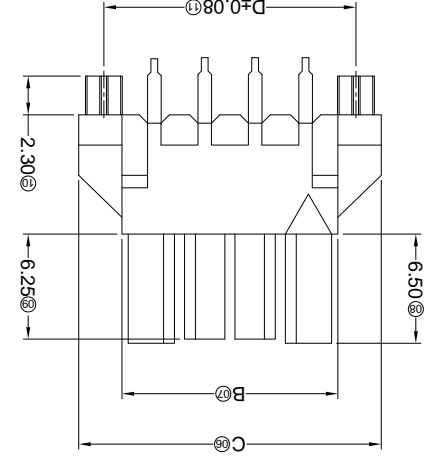
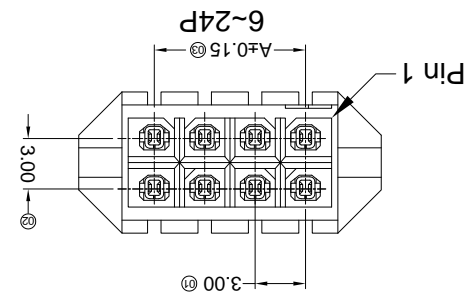
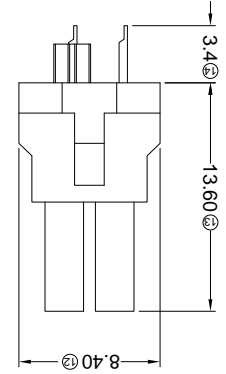
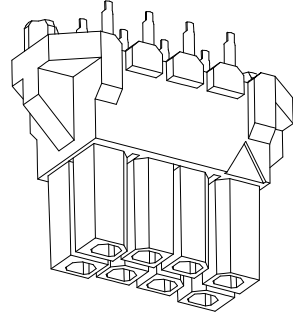

Recommended P.C.B Layout

For and on behalf of
XKB INDUSTRIAL PRECISION CO., LIMITED
 香港星坤工業精密有限公司

REVISIONS
 (Unauthorized Signatures)

MARK	DESCRIPTION	DATE	REVISED	APPROVED	UNSPECIFIED TOLERANCES
△ X					L > 63 ± 0.5
△ X					16 > L ≤ 63 ± 0.4
△ X					4 < L ≤ 16 ± 0.3
△ X					L ≤ 4 ± 0.2
					ANGULAR ± 5°

DATE	DATE	DATE	DATE	DATE	DATE	DATE	DATE
DNSD	DWN	CHKD	APPD				
SCALE: N/A	VIEW:	UNIT: mm	SIZE: A4				
MODEL TYPE: X3025TF-PXXX	PART NO.:	3.00 mm Crimp Style Connectors	DWG NO.:				
WEIGHT: 1.0g	SHEET: 1/1	REVISION: A0					

PART NO	Material	Wire Range	Insulation O.D.	Finish	Used in XKB Housing
X3025TF-PG30	Phosphor Bronze	AWG#20-24	1.85mm(Max)	Stamping Before Plating:30~50u" Ni;Contact Area Gold:30u" Min.	X3025HM
X3025TF-PG15				Stamping Before Plating:30~50u" Ni;Contact Area Gold:15u" Min.	
X3025TF-PG01				Stamping Before Plating:30~50u" Ni;Contact Area Gold Flash	
X3025TF-PSN				Stamping Before Plating:30~50u" Ni;70~120u" Sn	

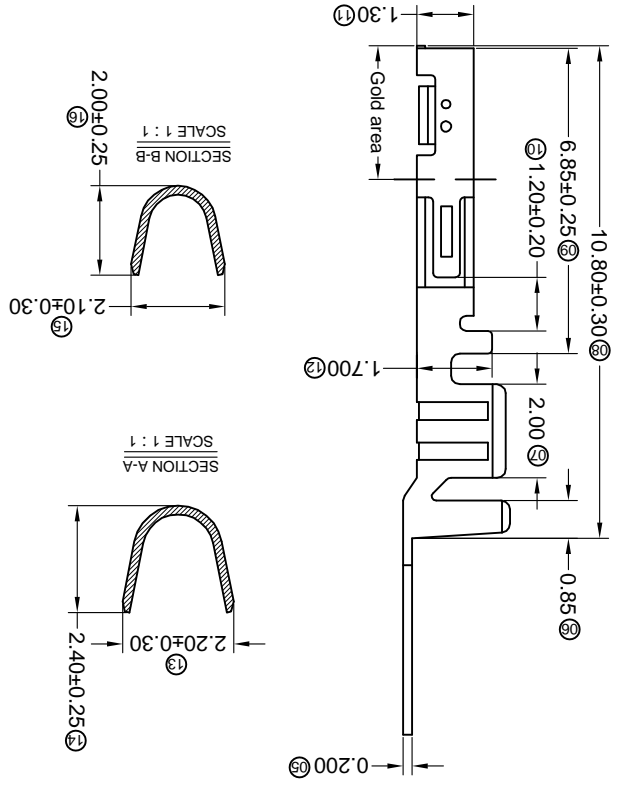
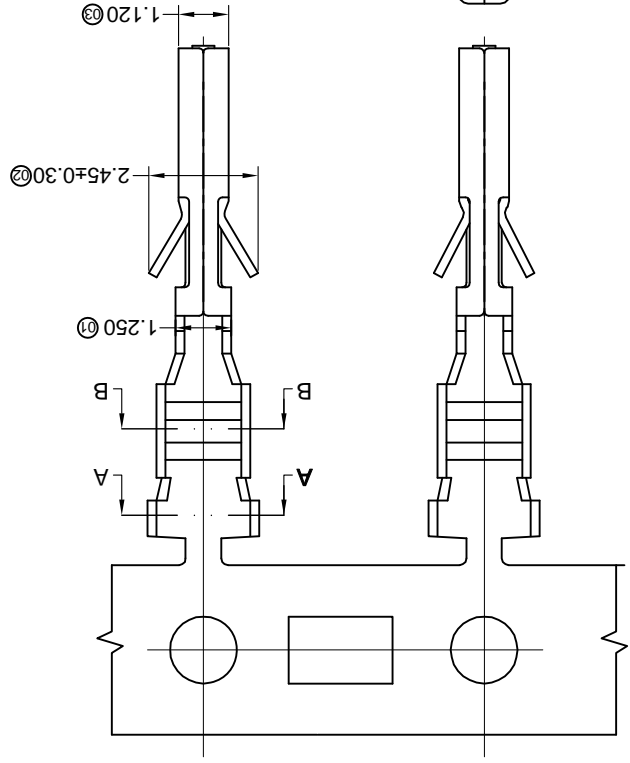
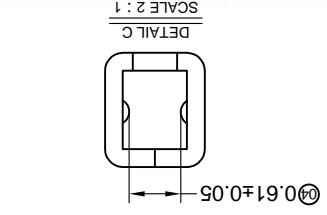

X3025 T F-P XX X-X
 ① Series Number
 ② Category: T-terminal
 ③ Shape: F-Female Terminal
 ④ Material: P-Phosphor bronze
 ⑤ Plating style:
 ⑥ G-Gold-Plated Contact
 *01-Gold Flash *15-15u" *30-30u"
 SN-Bright tin plating 70-120u"
 ⑦ Plating method:
 Blank-Stamping before plating
 ⑧ Mold No./Mark/Special No.

- Specifications :
- Voltage rating: 250V AC / DC
 - Current rating: 5A AC / DC
 - Withstanding voltage: 1000V AC/minute
 - Temperature range: -40°C~+85°C
 - Insulation resistance: ≥1000MΩ
 - Contact resistance: ≤10mΩ
 - After environmental testing: ≤20mΩ

REVISIONS
Authorized Signature(s)

MARK	DESCRIPTION	DATE	REVISED	APPROVED	UNSPECIFIED TOLERANCES
△ X					L > 63
△ X					16 > L ≤ 63
△ X					4 < L ≤ 16
△ X					L ≤ 4
					ANGULAR ± 5°

For and on behalf of
KKB INDUSTRIAL PRECISION CO., LIMITED
香港星坤工業精密有限公司

DATE	SCALE: N/A	MODEL TYPE: X3025TM-PXX	DNSD
DATE	VIEW:	PART NO.: 3.00 mm Crimp Style Connectors	DWN
DATE	UNIT: mm	DWG NO.:	CHKD
DATE	SIZE: A4	WEIGHT: 1.0g	APPD
		SHEET: 1/1	
		REVISION: A0	

PART NO	Material	Wire Range	Insulation O.D.	Finish
X3025TM-PSN	Phosphor Bronze AWG#20-24	1.85mm(Max)		Stamping Before Plating:30u" Ni;70u" Sn
X3025TM-PG01				Stamping Before Plating:30u" Ni>Contact Area Gold Flash
X3025TM-PG15				Stamping Before Plating:30u" Ni>Contact Area Gold:15u" Min.
X3025TM-PG30				Stamping Before Plating:30u" Ni>Contact Area Gold:30u" Min.

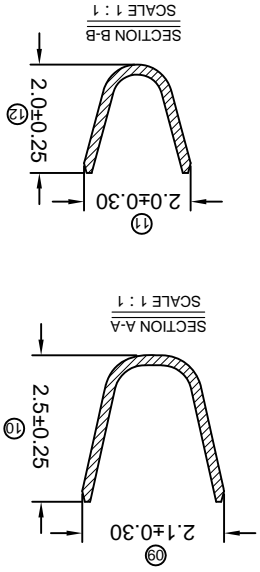
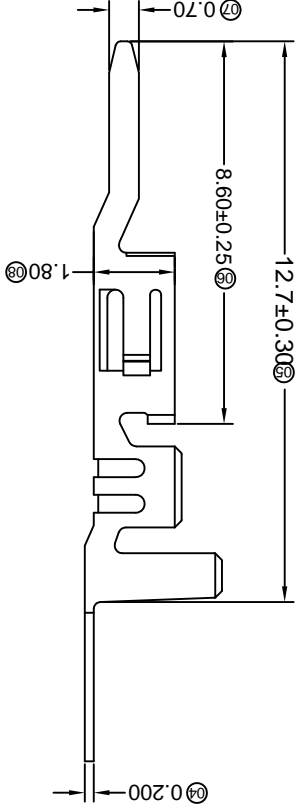
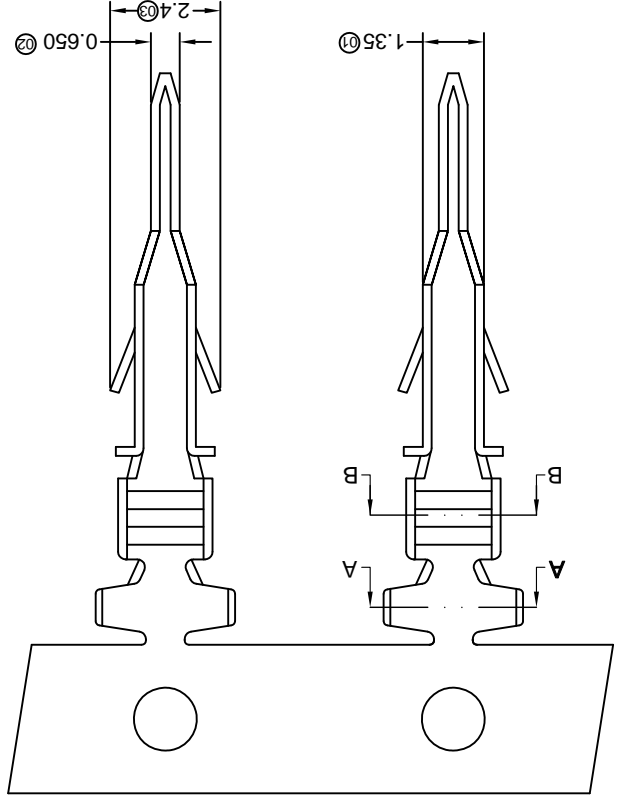

- Specifications :**
- Voltage rating: 250V AC / DC
 - Current rating: 5A AC / DC
 - Withstanding voltage: 1000V AC/minute
 - Temperature range: -25°C~+85°C
 - Insulation resistance: ≥1000MΩ
 - Contact resistance: ≤10mΩ
 - After environmental testing: ≤20mΩ
- X3025 T-M-P XX X-X**
- ① Series Number
 - ② Category: T-terminal
 - ③ Shape: M-Male Terminal
 - ④ Material: P-Phosphor bronze
 - ⑤ Plating style: G-Gold-Plated Contact
 - ⑥ Plating method: SN-Bright tin plating 70u"
 - ⑦ *01-Gold Flash *15-15u" *30-30u"
 - ⑧ Mold No./Mark/Special No.

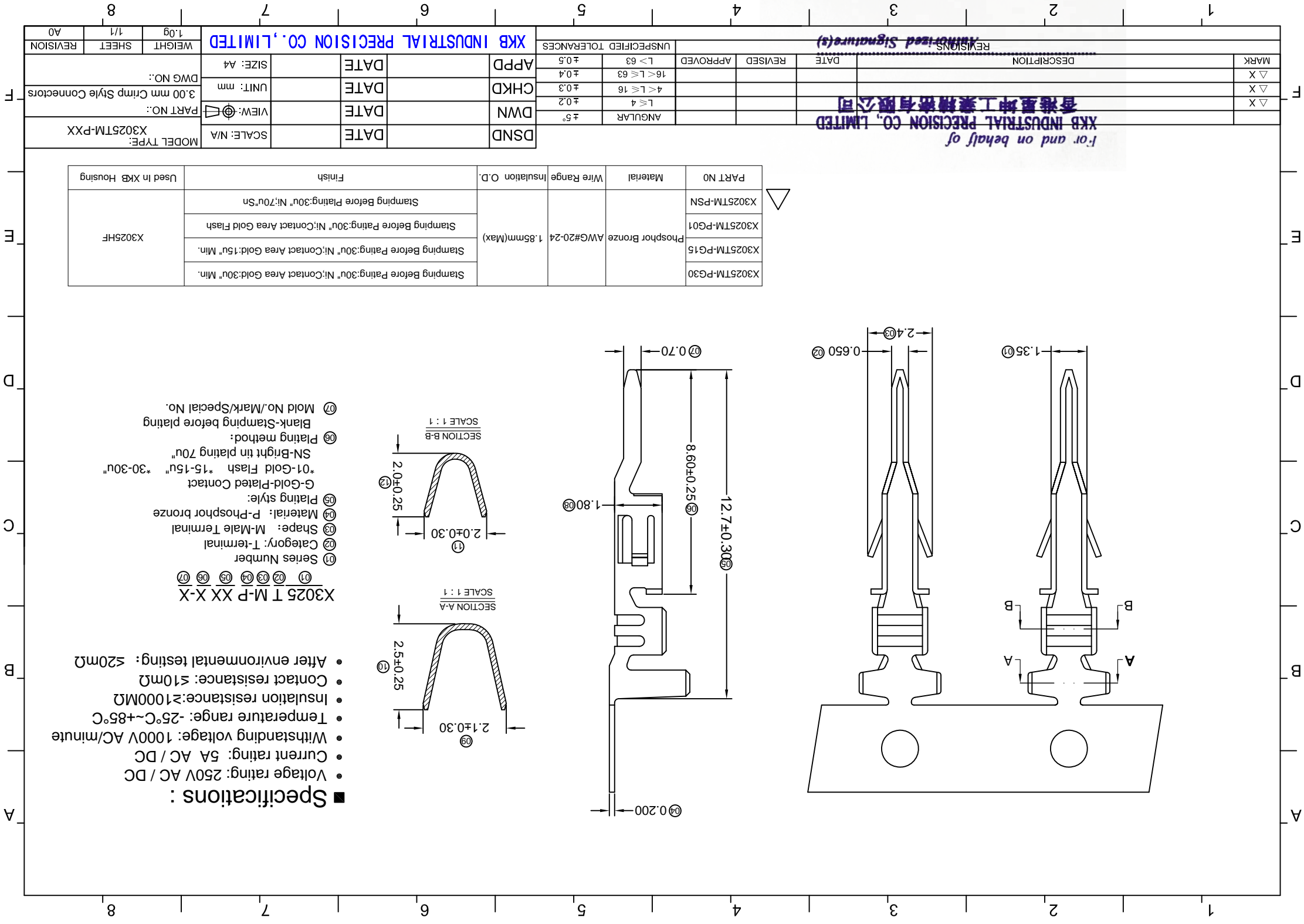

For and on behalf of
KKB INDUSTRIAL PRECISION CO., LIMITED
 香港星坤工業精密有限公司

REVISIONS
 Authorized Signatures(s)

MARK	DESCRIPTION	DATE	REVISED	APPROVED	UNSPECIFIED TOLERANCES
△ X					L > 63 L ≤ 63
△ X					4 ≤ L ≤ 16
△ X					L ≤ 4
					ANGULAR ± 5°

DATE	DATE	DATE	DATE	DATE	DATE
SCALE: N/A	VIEW:	UNIT: mm	SIZE: A4	MODEL TYPE: X3025WR-2*XX-N0XXX	PART NO.: 3.00 mm Crimp Style Connectors
DWNG NO.:					
WEIGHT	SHEET	REVISION			
1.0g	1/1	A0			

2P P.C.B LAYOUT

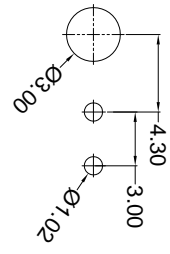

4P-6P P.C.B LAYOUT

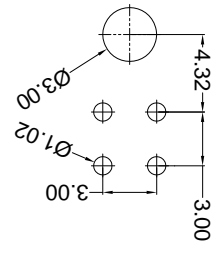

8P-24P P.C.B LAYOUT

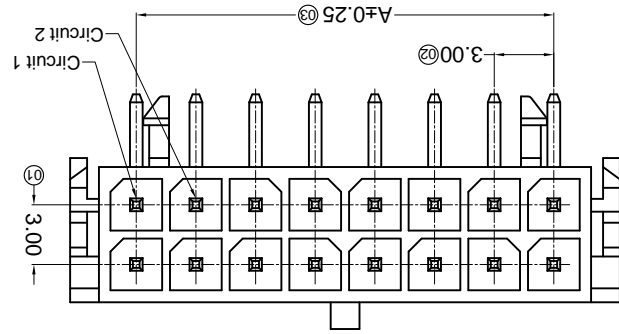
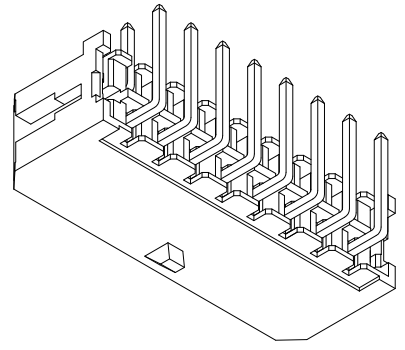
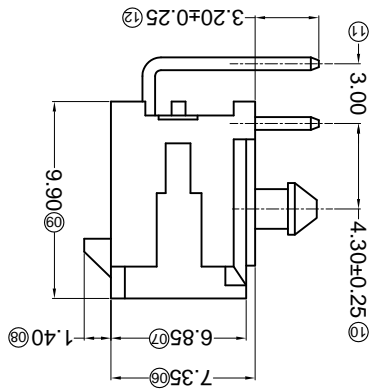
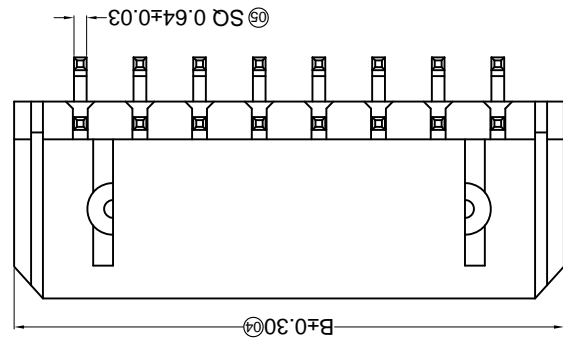
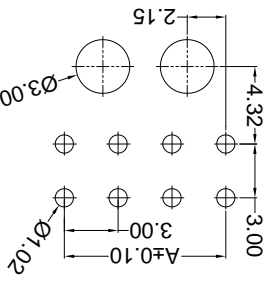

Part No.	Material	Material(Pin)	Finish(Pin)	Mates With
X3025WR-2*XX-46SN	PA46 UL 94V-0	Brass	Tin-Plated	KKB Housing
X3025WR-2*XX-46G01	PA46 UL 94V-0	Brass	Contact Gold	KKB Housing

Scale 1:3

Dimensions (mm)	A	B
2*12	33.00	39.65
2*11	30.00	36.65
2*10	27.00	33.65
2*09	24.00	30.65
2*08	21.00	27.65
2*07	18.00	24.65
2*06	15.00	21.65
2*05	12.00	18.65
2*04	9.00	15.65
2*03	6.00	12.65
2*02	3.00	9.65
2*01	---	6.65

- ① Series No.
- ② Category: W-water
- ③ Welding Board Angle: R-90°
- ④ Welding Way: Blank-DIP
- ⑤ Row No.-Pin No.: 2*XX-2*01P-2*12P
- ⑥ Special NO.:
- ⑦ Material: 46-PA46 94V-0
- ⑧ Planting Category: G01-Contact Gold Flash
- ⑨ Plating Category: SN-Bright tin plating
- ⑩ Color: Blank-natural color

- Specifications:
- Voltage rating: 250V AC / DC
 - Current rating: 5A AC / DC
 - Withstanding voltage: 1000V AC/minute
 - Temperature range: -25°C~+85°C
 - Insulation resistance: ≥1000MΩ
 - Contact resistance: ≤10mΩ
 - After environmental testing: ≤20mΩ

REVISIONS
Authorized Signature(s)

MARK	DESCRIPTION	DATE	REVISED	APPROVED	UNSPECIFIED TOLERANCES
△ X					L > 63 ± 0.5
△ X					16 < L ≤ 63 ± 0.4
△ X					4 < L ≤ 16 ± 0.3
△ X					L ≤ 4 ± 0.2
					ANGULAR ± 5°

For and on behalf of
XKB INDUSTRIAL PRECISION CO., LIMITED
香港星坤工業精密有限公司

XKB INDUSTRIAL PRECISION CO., LIMITED

APPD	DATE	SIZE:	A4
CHKD	DATE <td>UNIT:</td> <td>mm</td>	UNIT:	mm
DWN	DATE <td>VIEW:</td> <td>①</td>	VIEW:	①
DSND	DATE <td>SCALE:</td> <td>N/A</td>	SCALE:	N/A
MODEL TYPE:		X3025WR-2*XXC-XXX	
PART NO.:		3.00 mm Crimp Style Connectors	
DWG NO.:			
WEIGHT	SHEET	REVISION	
1.0g	1/1	A0	

Recommended P.C.B Layout
General Tolerance±0.05

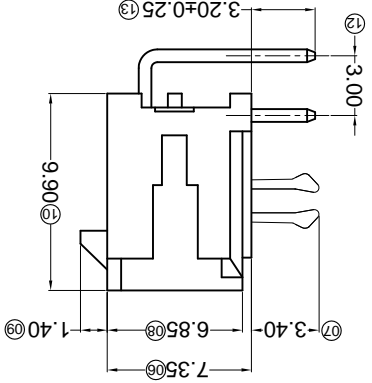
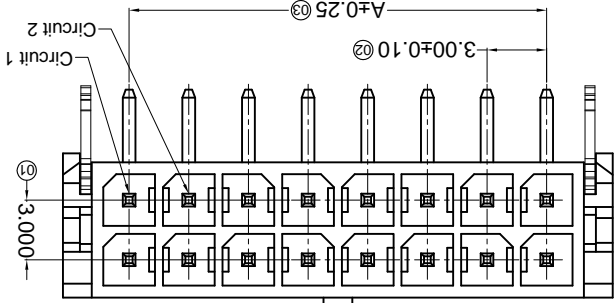
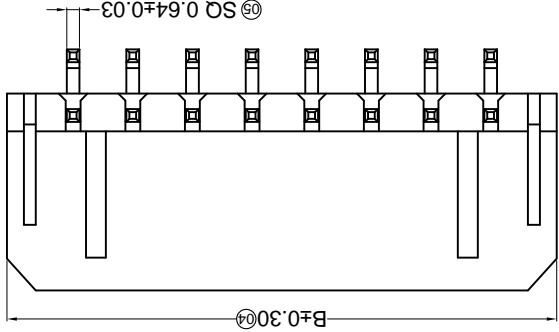
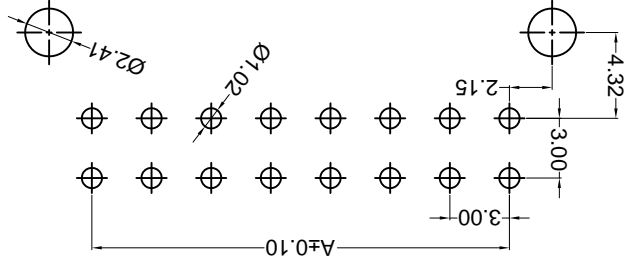

Part No.	Material	Material(Pin)	Finish(Pin)	Mates With(XB Housing)
X3025WR-2*XXC-66SN	Nylon 66 UL 94V-0	Brass	Tin-Plated	X3025H
X3025WR-2*XXC-46SN	Nylon 46 UL 94V-0	Brass	Gold Flash	
X3025WR-2*XXC-LPSN	LCP UL 94V-0			
X3025WR-2*XXC-66G2	Nylon 66 UL 94V-0			

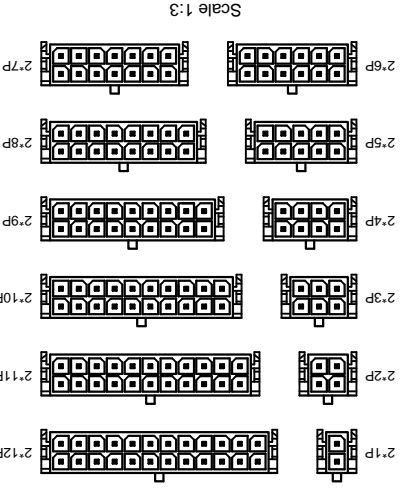

Poles	A	B	Dimensions (mm)	
2*01	---	6.65	2*01	3.00
2*02	3.00	9.65	2*02	6.00
2*03	6.00	12.65	2*03	9.00
2*04	9.00	15.65	2*04	12.00
2*05	12.00	18.65	2*05	15.00
2*06	15.00	21.65	2*06	18.00
2*07	18.00	24.65	2*07	21.00
2*08	21.00	27.65	2*08	24.00
2*09	24.00	30.65	2*09	27.00
2*10	27.00	33.65	2*10	30.00
2*11	30.00	36.65	2*11	33.00
2*12	33.00	39.65	2*12	36.00

Specifications :

- Voltage rating: 250V AC / DC
- Current rating: 5A AC / DC
- Withstanding voltage: 1000V AC/minute
- Temperature range: -25°C~+85°C
- Insulation resistance: ≥1000MΩ
- Contact resistance: ≤10mΩ
- After environmental testing: ≤20mΩ

- ① Series No.
- ② Category: W-water
- ③ Welding Board Angle: R-90°
- ④ Welding Way: Blank-DIP
- ⑤ Row No.-Pin No.: 2*XX-2*01P~2*12P
- ⑥ Special NO.: C-The harpoon
- ⑦ Material:
- ⑧ Planting Category: 46-P A46 94V-0 66-P A66 94V-0 LP-LCP 94V-0
- ⑨ G*:Gold-Plated Contact *02-2u"
- ⑩ SN-Bright tin plating 70u"
- ⑪ Color: Blank-natural color

X3025 W R - X - 2*XX - C-XX XX XX

① ② ③ ④ ⑤ ⑥ ⑦ ⑧ ⑨

For and on behalf of
KXB INDUSTRIAL PRECISION CO., LIMITED
 香港星坤工業精密有限公司

REVISIONS
 Authorized Signature(s)

MARK	DESCRIPTION	DATE	REVISED	APPROVED	UNSPECIFIED TOLERANCES
△ X					L > 63
△ X					16 < L ≤ 63
△ X					4 < L ≤ 16
△ X					L ≤ 4
					ANGULAR
					± 5°

DATE	DATE	DATE	DATE	DATE	DATE	DATE	DATE
DSND	DWN	CHKD	APPD				
SCALE: N/A	VIEW:	UNIT: mm	SIZE: A4				
MODEL TYPE: X3025WR-2*XXH-LPSN	PART NO.:	3.00 mm Crimp Style Connectors		DWG NO.:			
		WEIGHT	SHEET	REVISION			
		1.0g	1/1	A0			

PCB LAYOUT : Component side

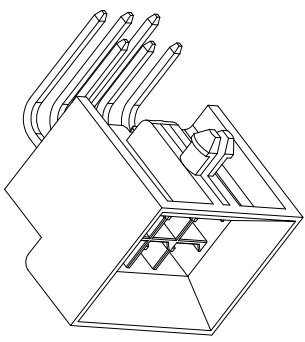
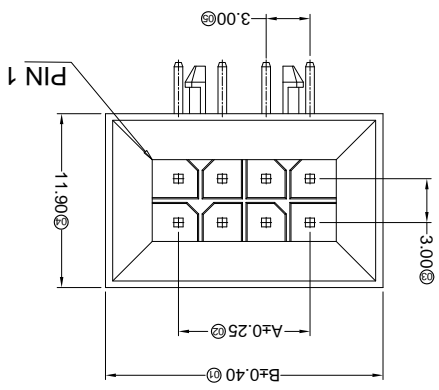
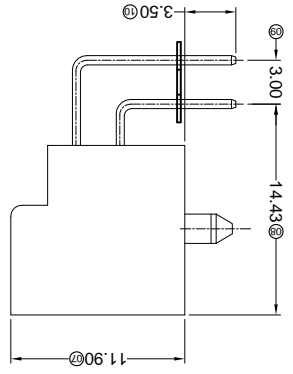
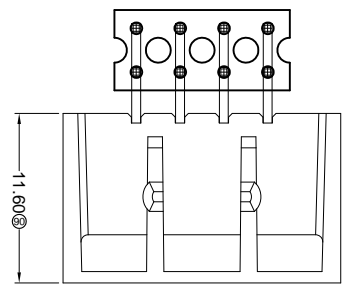
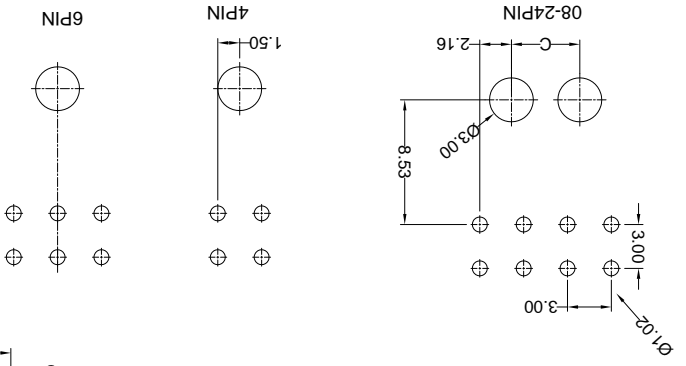

Part No.	Material	Material(Pin)	Finish(Pin)	Mates With XKB Housing
X3025WR-2*XXH-LPSN	LCP UL 94V-0	Brass	Tin-Plated	X3025H

Poles	Dimensions (mm)		
	A	B	C
2*02	3.00	13.00	2*08
2*03	6.00	16.00	2*09
2*04	9.00	19.00	4.68
2*05	12.00	22.00	7.68
2*06	15.00	25.00	10.68
2*07	18.00	28.00	13.68

- Specifications :**
- Voltage rating: 250V AC / DC
 - Current rating: 5A AC / DC
 - Withstanding voltage: 1500V AC/minute
 - Temperature range: -25°C~+85°C
 - Insulation resistance: ≥1000MΩ
 - Contact resistance: ≤10mΩ
 - After environmental testing: ≤20mΩ
- ① Series No.
 X3025 WR X-2*XX H-LP SN XX
- ② ③ ④ ⑤ ⑥ ⑦ ⑧ ⑨
- ⑩ Category: W-wafer
- ⑪ Welding Board Angle: R-90°
- ⑫ Welding Way: Blank-DIP
- ⑬ Row No.-Pin No.: 2*XX-2*01P~2*12P
- ⑭ Special NO. : H-With Base and positioning column
- ⑮ Material: LP-LCP 94V-0
- ⑯ Planting Category: SN-Bright tin plating
- ⑰ Color: Blank-natural color

For and on behalf of
KKB INDUSTRIAL PRECISION CO., LIMITED
 香港星坤工業精密有限公司

REVISIONS
 Authorized Signature(s)

MARK	DESCRIPTION	DATE	REVISED	APPROVED	UNSPECIFIED TOLERANCES
△ X					L > 63
△ X					16 < L ≤ 63
△ X					4 < L ≤ 16
△ X					L ≤ 4
					ANGULAR
					± 5°
					± 0.2
					± 0.3
					± 0.4
					± 0.5

REVISION	SHEET	WEIGHT	8
A0	1/1	1.0g	

DATE	SCALE: N/A	MODEL TYPE: X3025WRS-2*XXC-XXXX	7

DATE	VIEW:	PART NO.: X3025WRS-2*XXC-XXXX	6

DATE	UNIT: mm	DWG NO.:	5

DATE	SIZE: A4	REVISION	4

PART NO	Material	Material(Pin)	Finish(Pin)	(Solder Tabs)	(Solder Tabs)	Mates With XKB Housing
X3025WRS-2*XXC-LPSW	LCP UL 94V-0	Brass	Ni:50u"Min; Sn:120u"Min;	Brass	Finish Tabs	Mates With XKB Housing
X3025WRS-2*XXC-LPSN	LCP UL 94V-0	Brass	Ni:50u"Min; Sn:120u"Min;	Brass	Tin-Plated	Mates With XKB Housing
X3025WRS-2*XXC-NOSN	PA66 UL 94V-0	Brass	Ni:50u"Min; Sn:120u"Min;	Brass	Matte Tin Plating	Mates With XKB Housing

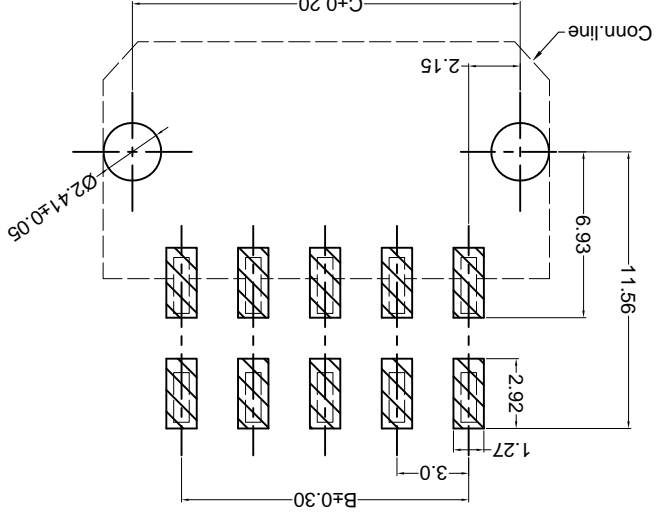
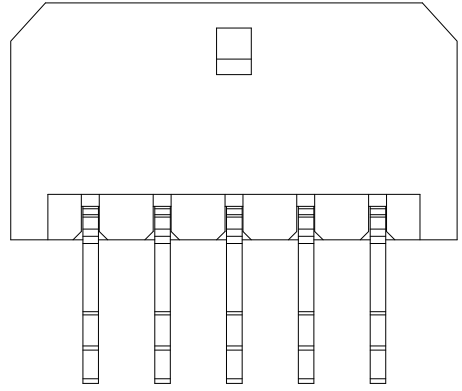
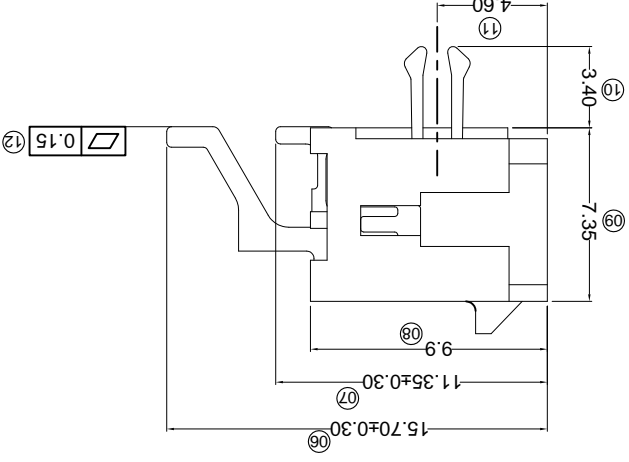
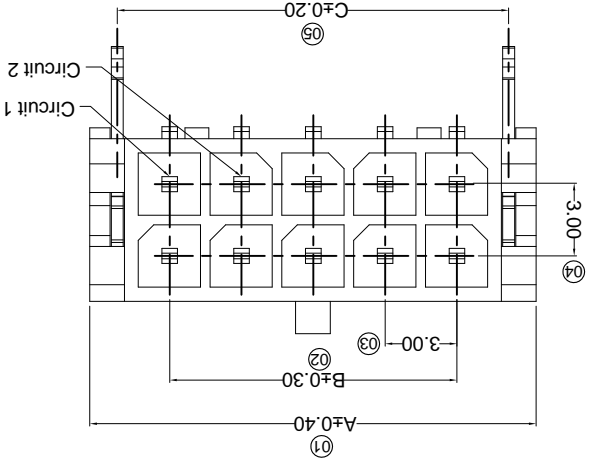

- Specifications :
- Voltage rating: 250V AC / DC
 - Current rating: 5A AC / DC
 - Withstanding voltage: 1000V AC/minute
 - Temperature range: -25°C~+85°C
 - Insulation resistance: ≥1000MΩ
 - Contact resistance: ≤10mΩ
 - After environmental testing: ≤20mΩ

X3025 W R S-2*XX C-XX XX XX
 ① Series No.
 ② Category: W-water
 ③ Welding Board Angle: R-90°
 ④ Welding Way: S-SMT
 ⑤ Row No.-Pin No.: 2*XX-Double row
 ⑥ Special NO.: C-The harpoon
 ⑦ Material: LP-LCP 94V-0
 ⑧ Material: N0-PA66 94V-0
 ⑨ Plating Category:
 SN-Bright tin plating 70u"
 SW-Fog Tin plating
 Color:
 ⑩ Blank-natural color

Poles	A	B	C
02	6.65	---	4.20
04	9.65	3.00	7.20
06	12.65	6.00	10.20
08	15.65	9.00	13.20
10	18.65	12.00	16.20
12	21.65	15.00	19.20
14	24.65	18.00	22.20
16	27.65	21.00	25.20
18	30.65	24.00	28.20
20	33.65	27.00	31.20
22	36.65	30.00	34.20
24	39.65	33.00	37.20

Dimensions(mm)

REVISIONS (Authorized Signatures)

MARK	DESCRIPTION	DATE	REVISED	APPROVED	UNSPECIFIED TOLERANCES
△ X					L > 63 ± 0.5
△ X					16 < L ≤ 63 ± 0.4
△ X					4 < L ≤ 16 ± 0.3
△ X					L ≤ 4 ± 0.2
					ANGULAR ± 5°

For and on behalf of
KXB INDUSTRIAL PRECISION CO., LIMITED
 香港星坤工業精密有限公司

KXB INDUSTRIAL PRECISION CO., LIMITED

MODEL TYPE:	SCALE: N/A	DATE	DNSD
PART NO.:	VIEW:	DATE	DWN
300 mm Crimp Style Connectors	UNIT: mm	DATE	CHKD
DWG NO.:	SIZE: A4	DATE	APPD
REVISION	SHEET	WEIGHT	
A0	1/1	1.0g	

PART NO	Material	Material(Pin)	Finish(Pin)	Material (Solder Tabs)	Finish (Solder Tabs)	Mates With XKB Housing
X3025WRS-2*XXD-LPSN	LCP UL 94V-0	Brass	Tin-Plated	Brass	Tin-Plated	X3025H
X3025WRS-2*XXD-LPG06			Ni:50µ/Min;Sr:120µ/Min; Contact Area Gold:5µ			
X3025WRS-2*XXD-LPSW			Matte tin			

Poles	Dimensions (mm)		Poles		Dimensions (mm)	
	A	B	A	B	A	B
2*01	6.65	---	2*07	24.65	18.00	
2*02	9.65	3.00	2*08	27.65	21.00	
2*03	12.65	6.00	2*09	30.65	24.00	
2*04	15.65	9.00	2*10	33.65	27.00	
2*05	18.65	12.00	2*11	36.65	30.00	
2*06	21.65	15.00	2*12	39.65	33.00	

- ① Series No.
- ② Category: W-WAFER
- ③ Welding Board Angle: R-Straight 180°
- ④ Welding Way: S-SMT
- ⑤ Row No.-Pin No.: 2*XX-2*02P~2*22P
- ⑥ Plug the Pin & Special No.: D-With Solder Tabs
- ⑦ Material: LP-LCP 94V-0
- ⑧ Plating Category: SN-Bright Tin Plating; G05-Contact Gold 5µ
- ⑨ SW-Fog Tin plating
- ⑩ Color: Blank-Natural Color

Recommended P.C.B Layout
 General Tolerance±0.05
 X3025 W R S-2*XX D-LP XX XX

- Specifications:
- Voltage rating: 250V AC / DC
- Current rating: 5A AC / DC
- Withstanding voltage: 1000V AC/minute
- Temperature range: -25°C~+85°C
- Insulation resistance: ≥1000MΩ
- Contact resistance: ≤10mΩ
- After environmental testing: ≤20mΩ

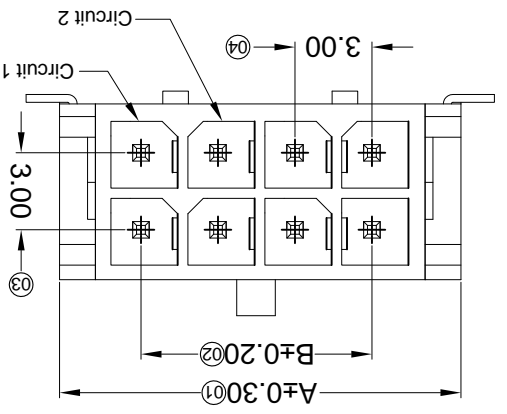
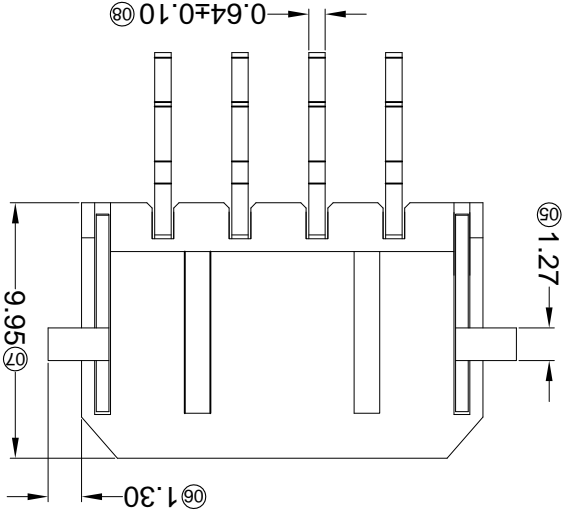
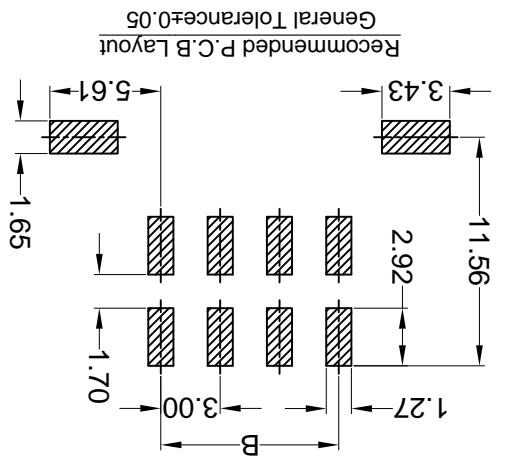
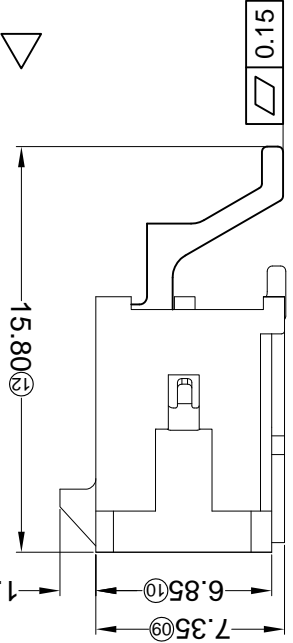

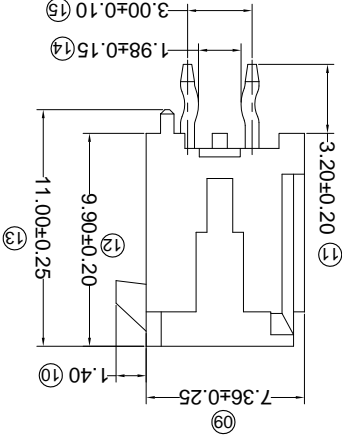
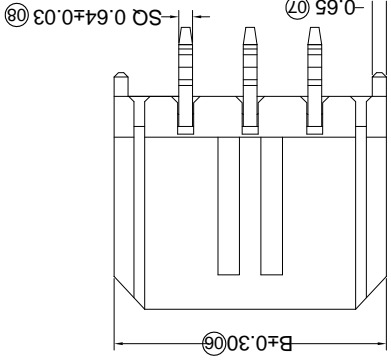
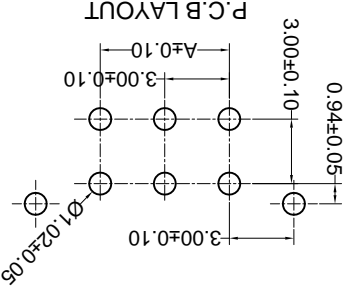
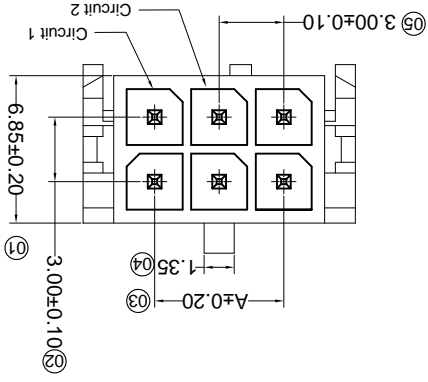

PART NO	Material	Material(Pin)	Finish(Pin)	Mates With XKB Housing
X3025WV-2*XX-46V01	PA46 UL 94V-0	Brass	Tin-Plated	X3025H
X3025WV-2*XX-LP5N	LCP UL 94V-0			
X025WV-2*XX-66B5N	PA66 UL 94V-0	Gold-Flash	Gold-Flash	
X3025WV-2*XX-46S5N	PA46 UL 94V-0			
X3025WV-2*XX-PT5N	PBT UL 94V-0			
X3025WV-2*XX-PT5N	PBT UL 94V-0			

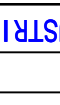
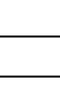
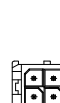
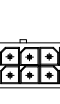
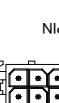
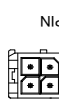
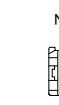
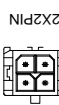
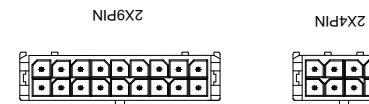
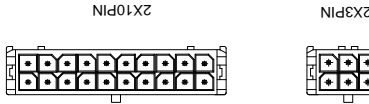
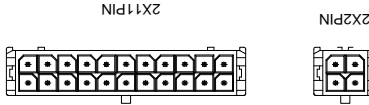
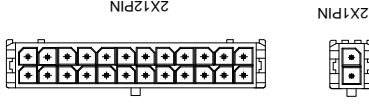
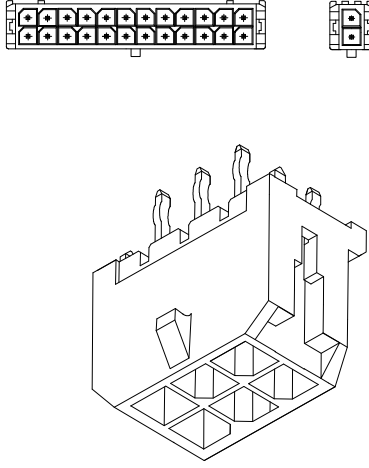

MARK	DESCRIPTION	DATE	REVISION	APPROVED	UNSPECIFIED TOLERANCES
△ X					L > 63 ±0.5
△ X					16 < L ≤ 63 ±0.4
△ X					4 < L ≤ 16 ±0.3
					L ≤ 4 ±0.2
					ANGULAR ±5°

For and on behalf of
XKB INDUSTRIAL PRECISION CO., LIMITED
 香港星坤工業精密有限公司

REVISIONS
 Authorized Signature(s)

DSND	DATE	SCALE: N/A	MODEL TYPE: X3025WV-2*XX-XXXX
DWN	DATE <td>VIEW: </td> <td>PART NO.:</td>	VIEW:	PART NO.:
CHKD	DATE <td>UNIT: mm</td> <td>DWG NO.:</td>	UNIT: mm	DWG NO.:
APPD	DATE <td>SIZE: A4</td> <td></td>	SIZE: A4	

Poles	Dimensions (mm)		Poles	Dimensions (mm)	
	A	B		A	B
2*01	---	6.65	2*07	18.00	24.65
2*02	3.00	9.65	2*08	21.00	27.65
2*03	6.00	12.65	2*09	24.00	30.65
2*04	9.00	15.65	2*10	27.00	33.65
2*05	12.00	18.65	2*11	30.00	36.65
2*06	15.00	21.65	2*12	33.00	39.65

- ① Series No. X3025 W V X-2*XX X-XX XX XX ⑨
- ② Category: W-WAFER
- ③ Welding Board Angle: V-Straight 180°
- ④ Welding Way: Blank-DIP
- ⑤ Row No.-Pin No.: 2*XX-2*01P-2*22P
- ⑥ Plug the Pin & Special No.:
- ⑦ Material: 66-PA66 94V-0; PT-PBT 94V-0; 46-PA46 94V-0 LP-LCP 94V-0
- ⑧ Plating Category: SN-Bright Tin Plating; V01-All Gold Flash
- ⑨ Color: Blank-Natural Color

- Specifications:
- Voltage rating: 250V AC / DC
 - Current rating: 5A AC / DC
 - Withstanding voltage: 1000V AC/minute
 - Temperature range: -25°C~+85°C
 - Insulation resistance: ≥1000MΩ
 - Contact resistance: ≤10mΩ
 - After environmental testing: ≤20mΩ

For and on behalf of
KXB INDUSTRIAL PRECISION CO., LIMITED
 香港星坤工業精密有限公司

Authorized Signatures

MARK	DESCRIPTION	DATE	REVISED	APPROVED	UNSPECIFIED TOLERANCES
△ X					L > 63
△ X					16 > L ≤ 63
△ X					4 < L ≤ 16
△ X					L ≤ 4
					ANGULAR
					± 5°

REVISIONS	DATE	REVISED	APPROVED	UNSPECIFIED TOLERANCES
				L > 63
				16 > L ≤ 63
				4 < L ≤ 16
				L ≤ 4
				ANGULAR
				± 5°

DSND	DATE	SCALE: N/A	MODEL TYPE: X3025WV-2*XXC-46SN

DWN	DATE	VIEW:	PART NO:

CHKD	DATE	UNIT: mm	SIZE: A4

APPD	DATE	DMG NO.:
		3.00 mm Crimp Style Connectors

WEIGHT	SHEET	REVISION
1.0g	1/1	A0

KXB INDUSTRIAL PRECISION CO., LIMITED

PART NO	Material	Material(Pin)	Finish(Pin)	Mates With
X3025WV-2*XXC-46SN	PA46 UL 94V-0	Brass	Tin Plating Fog	X3025H
X3025WV-2*XXC-LPSW	LCP UL 94V-0			

Dimensions (mm)	Poles
24	A
22	B
20	
18	
16	
14	
12	
10	
08	
06	
04	
02	

- ① Series No.
- ② Category: W-water
- ③ Welding Board Angle: V-180°
- ④ Welding Way: Blank-DIP
- ⑤ Row No.-Pin No. 2*XX-Double row
- ⑥ Special NO.
- ⑦ Material: LP-LCP 94V-0 NO-PA9T 94V-0 46-PA46 94V-0
- ⑧ Planting Category: V** All Gold-Plated
- ⑨ *01-Gold Flash : *02-2u" ; *03-3u" ; *05-5u"
- ⑩ *10-10u" ; *15-15u" ; *30-30u" ; *50-50u"
- ⑪ SN-Bright tin plating 70u"
- ⑫ SN1-Bright tin plating 120u" Min. ;
- ⑬ SW-Fog Tin plating
- ⑭ Color: Blank-natural color

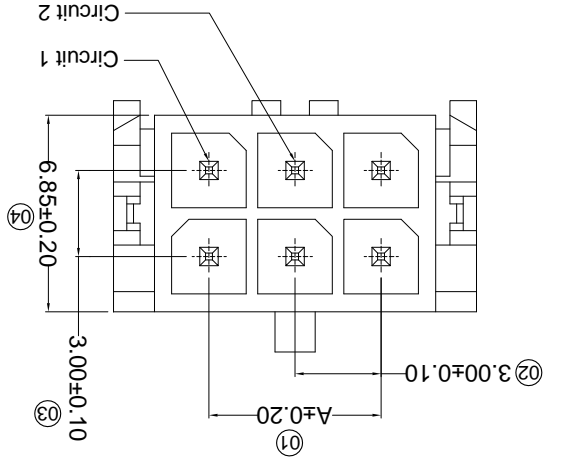
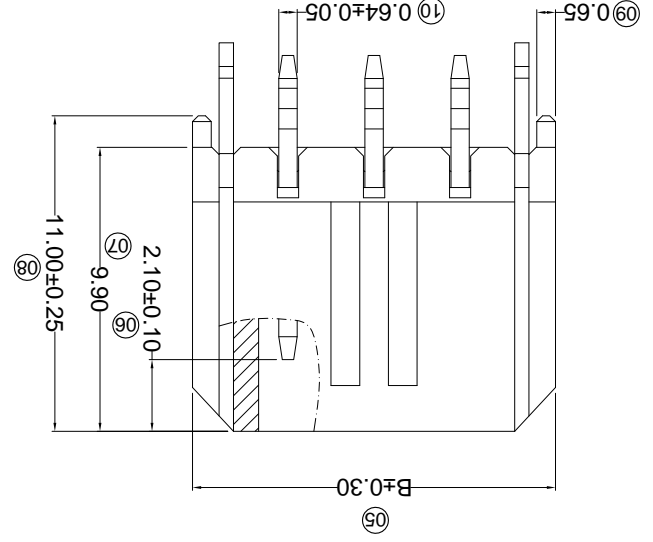
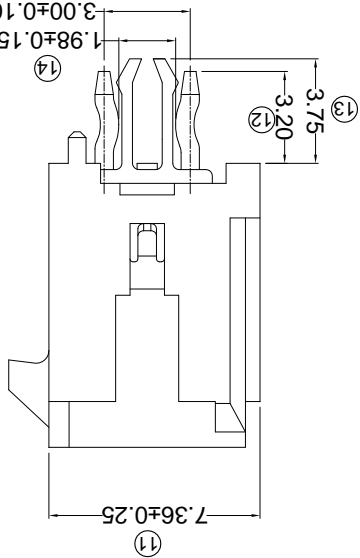

- Voltage rating: 250V AC / DC
- Current rating: 5A AC / DC
- Withstanding voltage: 1000V AC/minute
- Temperature range: -25°C~+85°C
- Insulation resistance: ≥1000MΩ
- Contact resistance: ≤10mΩ
- After environmental testing: ≤20mΩ

P.C.B LAYOUT

Circuit 1

Circuit 2

REVISIONS
Authorized Signatures

MARK	DESCRIPTION	DATE	REVISED	APPROVED	UNSPECIFIED TOLERANCES
△ X					L > 63
△ X					16 < L ≤ 63
△ X					4 < L ≤ 16
△ X					L ≤ 4
					ANGULAR
					± 5°

For and on behalf of
XKB INDUSTRIAL PRECISION CO., LIMITED
香港星坤工業精密有限公司

XKB INDUSTRIAL PRECISION CO., LIMITED

MODEL TYPE:	X3025WV-2*XXCN-LPSN
PART NO.:	
DWG NO.:	3.00 mm Crimp Style Connectors
WEIGHT	1.0g
SHEET	1/1
REVISION	A0

DSND	DATE	SCALE: N/A
DWN	DATE	VIEW:
CHKD	DATE	UNIT: mm
APPD	DATE	SIZE: A4
PART NO	Material	Material(Pin)
	LCP UL 94V-0	Brass
	X3025WV-2*XXCN-LPSN	Tin-Plated
		Mates With XKB Housing
		X3025H

Poles	A	B
02	--	6.65
04	3.00	9.65
06	6.00	12.65
08	9.00	15.65
10	12.00	18.65
12	15.00	21.65
14	18.00	24.65
16	21.00	27.65
18	24.00	30.65
20	27.00	33.65
22	30.00	36.65
24	33.00	39.65

- X3025 W V X-2*XX CN-LP SN XX
- ① Series No.
② Category:
W-water
③ Welding Board Angle:
V-180°
④ Welding Way:
Blank-DIP
⑤ Row No.-Pin No.
2*XX-Double row
⑥ Special NO.
C-The harpoon N-without K the feet
⑦ Material:
LP-LCP 94V-0
⑧ Plating Category:
V**All Gold-Plated
*01-Gold Flash ; *02-2u" ; *03-3u" ; *05-5u"
*10-10u" ; *15-15u" ; *30-30u" ; *50-50u"
SN-Bright tin plating 70u"
SN1-Bright tin plating 120u" Min. ;
SW-Fog Tin plating
⑨ Color:
Blank-natural color

- Specifications :
- Voltage rating: 250V AC / DC
 - Current rating: 5A AC / DC
 - Withstanding voltage: 1000V AC/minute
 - Temperature range: -25°C~+85°C
 - Insulation resistance: ≥1000MΩ
 - Contact resistance: ≤10mΩ
 - After environmental testing: ≤20mΩ

P.C.B LAYOUT

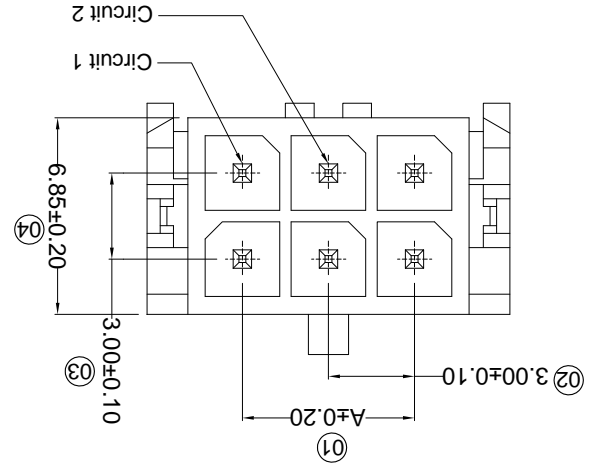
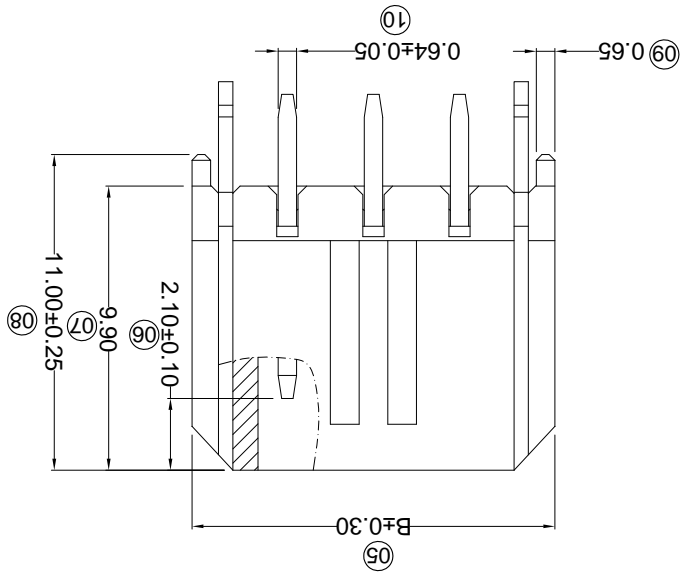
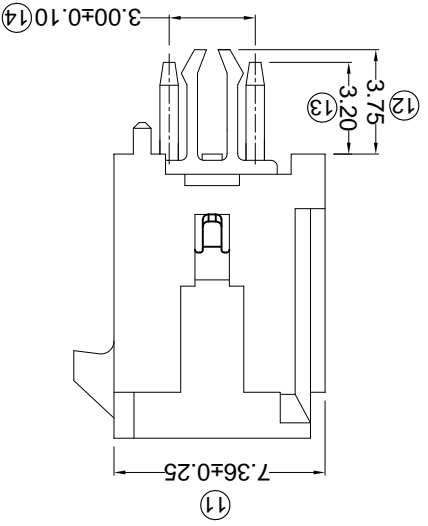
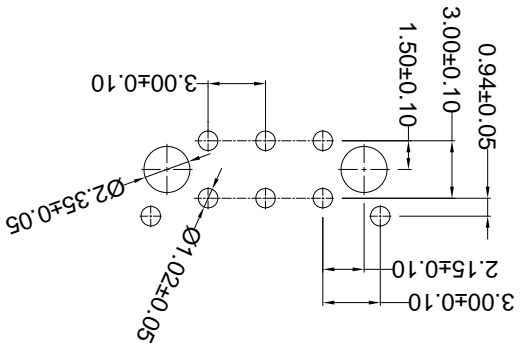

For and on behalf of
KXB INDUSTRIAL PRECISION CO., LIMITED
 香港星坤工業精密有限公司

MARK	DESCRIPTION	DATE	REVISED	APPROVED	UNSPECIFIED TOLERANCES
△ X					L > 63
△ X					16 < L ≤ 63
△ X					4 < L ≤ 16
△ X					L ≤ 4
					ANGULAR

REVISIONS	DATE	REVISED	APPROVED	DESCRIPTION

WEIGHT	1.0g
SHEET	1/1
REVISION	A0

SIZE:	A4
UNIT:	mm
DATE:	
DATE:	
DATE:	
DATE:	

VIEW:	VIEW: ①
SCALE:	N/A
MODEL TYPE:	X3025WV-2*XXH-LPSN
PART NO.:	
DWG NO.:	

Part No.	Material	Material(Pin)	Finish(Pin)	Tin-Plated	Mates With XKB Housing
X3025WV-2*XXH-LPSN	LCP UL 94V-0	Brass			X3025H

Poles	A	B	C
04	3.00	13.00	12.00
06	6.00	16.00	15.00
08	9.00	19.00	18.00
10	12.00	22.00	21.00
12	15.00	25.00	24.00
14	18.00	28.00	27.00
16	21.00	31.00	30.00
18	24.00	34.00	33.00
20	27.00	37.00	36.00
22	30.00	40.00	39.00
24	33.00	43.00	42.00

- ① Series No.
- ② Category: W-water
- ③ Welding Board Angle: V-180°
- ④ Welding Way: Blank-DIP
- ⑤ Row No.-Pin No.
- ⑥ 2*XX-Double row
- ⑦ Special NO.
- ⑧ H-Arrange ushering with positioning column
- ⑦ Material: LP-LCP 94V-0
- ⑧ Planting Category: V**All Gold-Plated
- ⑧ G**Gold-Plated Contact
- ⑧ *01-Gold Flash ; *02-2u" ; *03-3u" ; *05-5u"
- ⑧ *10-10u" ; *15-15u" ; *30-30u" ; *50-50u"
- ⑧ SN-Bright tin plating 70u"
- ⑧ SN1-Bright tin plating 120u"Min. ;
- ⑧ SW-Fog Tin plating
- ⑧ Color: Blank-natural color

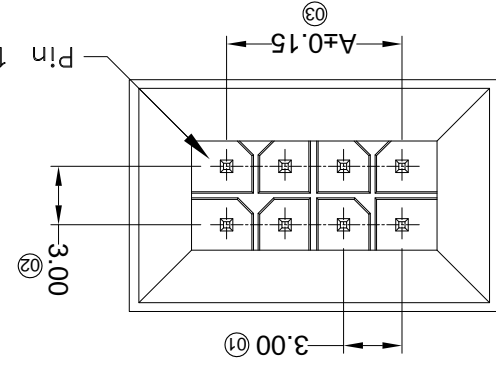
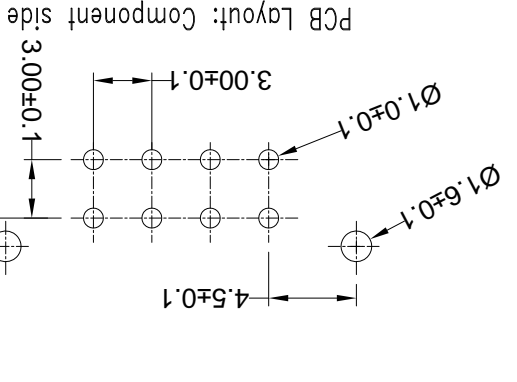
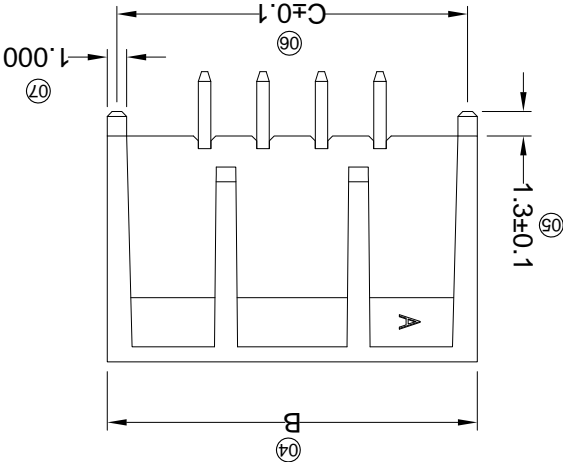
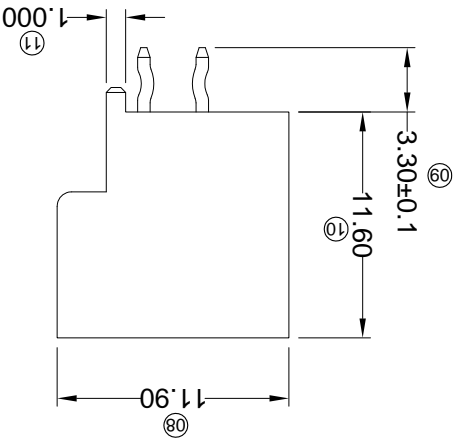

- Specifications :
- Voltage rating: 250V AC / DC
 - Current rating: 5A AC / DC
 - Withstanding voltage: 1000V AC/minute
 - Temperature range: -25°C~+85°C
 - Insulation resistance: ≥1000MΩ
 - Contact resistance: ≤10mΩ
 - After environmental testing: ≤20mΩ

X3025W V X-2*XXH-LPSNXX
 ① ② ③ ④ ⑤ ⑥ ⑦ ⑧ ⑨

REVISIONS
 (Authorized Signatures)

MARK	DESCRIPTION	DATE	REVISED	APPROVED	UNSPECIFIED TOLERANCES
△ X					L > 63
△ X					16 < L ≤ 63
△ X					4 < L ≤ 16
△ X					L ≤ 4
					ANGULAR
					± 5°

For and on behalf of
XKB INDUSTRIAL PRECISION CO., LIMITED
 香港星坤工業精密有限公司

XKB INDUSTRIAL PRECISION CO., LIMITED

DSND	DATE	SCALE: N/A	MODEL TYPE: X3025WVS-2*XXC-LPSW
DWN	DATE <td>VIEW: </td> <td>PART NO.:</td>	VIEW:	PART NO.:
CHKD	DATE <td>UNIT: mm</td> <td>3.00 mm Crimp Style Connectors</td>	UNIT: mm	3.00 mm Crimp Style Connectors
APPD	DATE <td>SIZE: A4</td> <td>DWG NO.:</td>	SIZE: A4	DWG NO.:
		WEIGHT	REVISION
		1.0g	1/1
			A0

Recommended P.C.B Layout
 General Tolerance±0.05

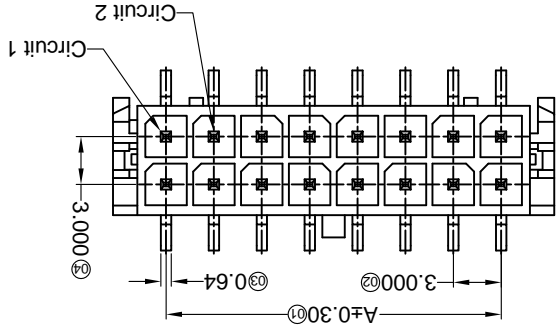
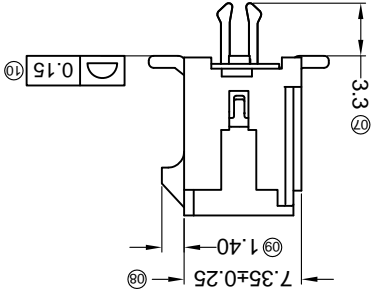
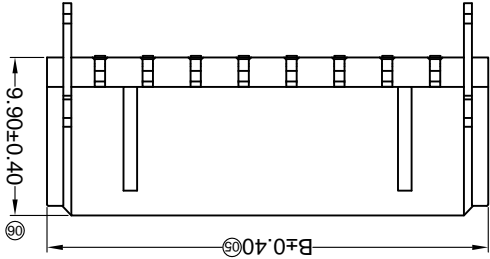
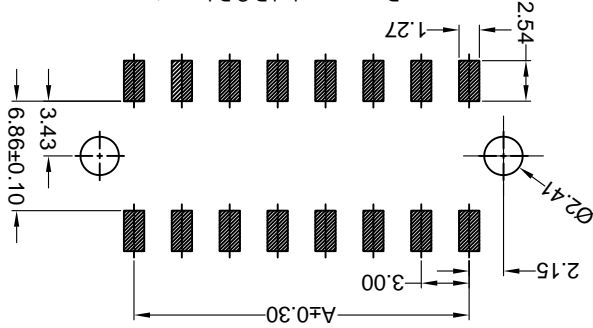

PART NO	Material	Material (Pn)	Finish (Pn)	(Solder Tabs)	Finish (Solder Tabs)	Mates With XKB Housing
X3025WVS-2*XXC-LPSN	LCP UL 94V-0	Brass	Tin-Plated	Material	Tin-Plated	X3025H
X3025WVS-2*XXC-LPSW	LCP UL 94V-0	Brass	Matte tin	Material	Matte tin	

Poles	Dimensions(mm)		Poles		Dimensions(mm)	
	A	B	A	B	A	B
2*01	---	6.65	2*07	18.00	24.65	39.65
2*02	3.00	9.65	2*08	21.00	27.65	30.65
2*03	6.00	12.65	2*09	24.00	30.65	36.65
2*04	9.00	15.65	2*10	27.00	33.65	39.65
2*05	12.00	18.65	2*11	30.00	36.65	39.65
2*06	15.00	21.65	2*12	33.00	39.65	39.65

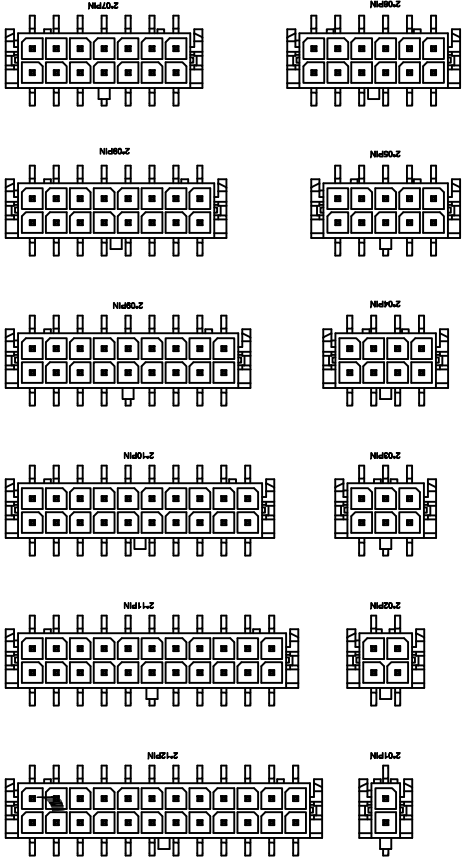

- ① Series No.
 ② Category: W-water
 ③ Welding Board Angle: V- Straight 180°
 ④ Welding Way: S-SMT
 ⑤ Row No-Pin No.: 2*XX-2*01P~2*12P
 ⑥ Plug the Pin & Special No.: C-The Harpoon
 ⑦ Material: LP-LCP 94V-0
 ⑧ Plating Category:
 ⑨ SN-Bright tin plating : SW-Matte Tin plating
 ⑩ Color: Blank-Natural color

X3025 W V S-2*XX C-LP XX XX

- Specifications :
- Voltage rating: 250V AC / DC
 - Current rating: 5A AC / DC
 - Withstanding voltage: 1000V AC/minute
 - Temperature range: -25°C~+85°C
 - Insulation resistance: ≥1000MΩ
 - Contact resistance: ≤10mΩ
 - After environmental testing: ≤20mΩ

For and on behalf of
KXB INDUSTRIAL PRECISION CO., LIMITED
 香港星坤工業精密有限公司

MARK	DESCRIPTION	DATE	REVISED	APPROVED	UNSPECIFIED TOLERANCES
△ X					L > 63
△ X					16 < L ≤ 63
△ X					4 < L ≤ 16
					L ≤ 4
					ANGULAR
					± 5°

REVISIONS	DATE	REVISED	APPROVED	UNSPECIFIED TOLERANCES
				L > 63
				16 < L ≤ 63
				4 < L ≤ 16
				L ≤ 4
				ANGULAR
				± 5°

DATE	SCALE: N/A	MODEL TYPE: X3025WVS-2*XXD-LPSW

DATE	VIEW:	PART NO.: X3025WVS-2*XXD-LPSW

DATE	UNIT: mm	DWG NO.:

DATE	SIZE: A4	REVISION

DATE	SCALE: N/A	MODEL TYPE: X3025WVS-2*XXD-LPSW

DATE	SCALE: N/A	MODEL TYPE: X3025WVS-2*XXD-LPSW

DATE	SCALE: N/A	MODEL TYPE: X3025WVS-2*XXD-LPSW

DATE	SCALE: N/A	MODEL TYPE: X3025WVS-2*XXD-LPSW

DATE	SCALE: N/A	MODEL TYPE: X3025WVS-2*XXD-LPSW

DATE	SCALE: N/A	MODEL TYPE: X3025WVS-2*XXD-LPSW

DATE	SCALE: N/A	MODEL TYPE: X3025WVS-2*XXD-LPSW

DATE	SCALE: N/A	MODEL TYPE: X3025WVS-2*XXD-LPSW

DATE	SCALE: N/A	MODEL TYPE: X3025WVS-2*XXD-LPSW

DATE	SCALE: N/A	MODEL TYPE: X3025WVS-2*XXD-LPSW

DATE	SCALE: N/A	MODEL TYPE: X3025WVS-2*XXD-LPSW

DATE	SCALE: N/A	MODEL TYPE: X3025WVS-2*XXD-LPSW

DATE	SCALE: N/A	MODEL TYPE: X3025WVS-2*XXD-LPSW

DATE	SCALE: N/A	MODEL TYPE: X3025WVS-2*XXD-LPSW

DATE	SCALE: N/A	MODEL TYPE: X3025WVS-2*XXD-LPSW

P.C.B. LAYOUT

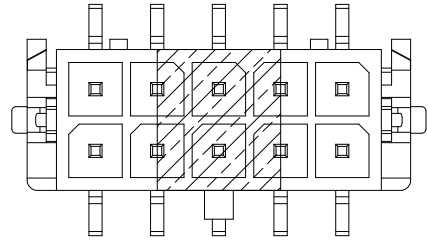
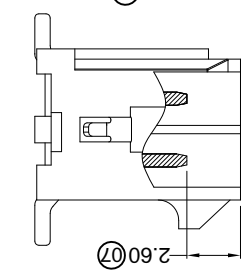
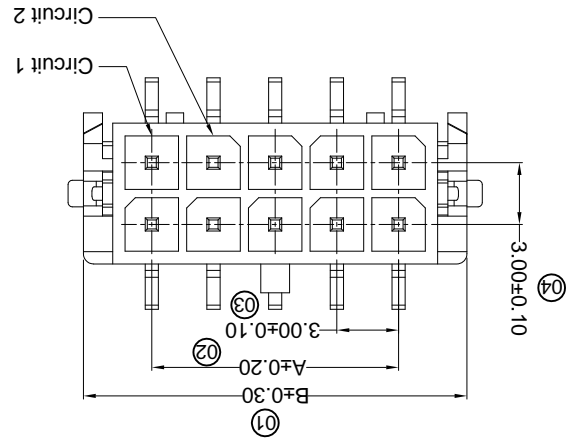
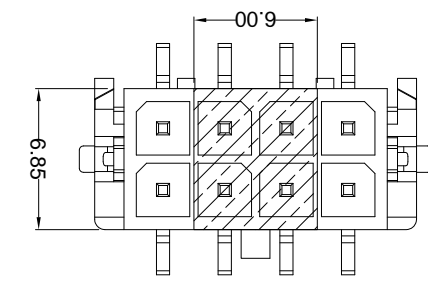
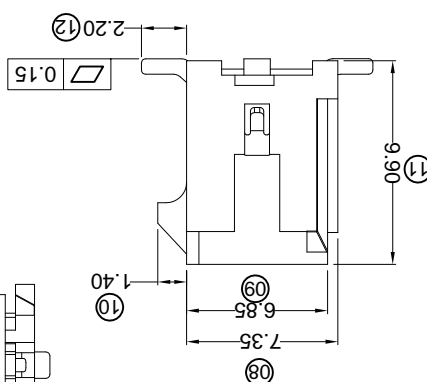
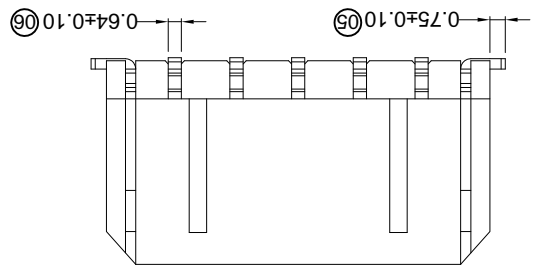
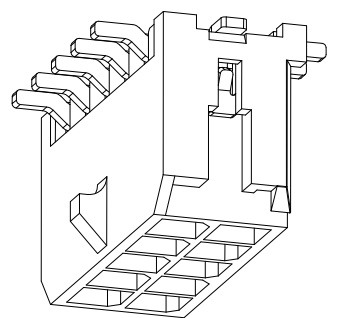
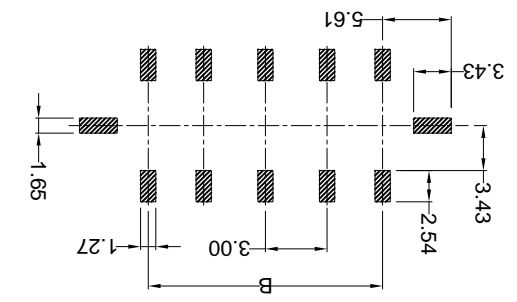

- ① Series No.
- ② Category: W-water
- ③ Weiding Board Angle: V- Stright 180°
- ④ Weiding Way: S-SMT
- ⑤ Row No.-Pin No.: 2*XX-2*01P-2*12P
- ⑥ Plug the Pin & Special No.: D-Solder Tabs
- ⑦ Material: LP-LCP 94V-0
- ⑧ Planting Category:
- ⑨ SN-Bright tin plating ; SW-Matte Tin plating
- ⑩ Color: Blank-Natural color

X3025 W V S-2*XX D-LP XX XX

- Specifications :
- Voltage rating: 250V AC / DC
 - Current rating: 5A AC / DC
 - Withstanding voltage: 1000V AC/minute
 - Temperature range: -25°C~+85°C
 - Insulation resistance: ≥1000MΩ
 - Contact resistance: ≤10mΩ
 - After environmental testing: ≤20mΩ

X-ON Electronics

Largest Supplier of Electrical and Electronic Components

Click to view similar products for [Headers & Wire Housings](#) category:

Click to view products by [XKB](#) manufacturer:

Other Similar products are found below :

[95000-104TRLF](#) [10135584-644402LF](#) [DF62W-EP2022PCA](#) [95000-106TRLF](#) [DF62W-2022SCA](#) [DF62W-EP2022PC](#) [2203348](#) [DF62W-2022SC](#) [1084018](#) [1029039](#) [1084017](#) [802-10-012-10-002000](#) [1112640](#) [1112639](#) [891-007-9SS-BST1T](#) [000-34000](#) [0008550134](#) [0009482033](#) [0009507031](#) [57102-F02-18ULF](#) [57102-S06-03LF](#) [57202-S52-04LF](#) [PCN6-15S-2.5E](#) [0039019024](#) [58102-G61-06LF](#) [582553-1](#) [0009485154](#) [0009508121](#) [0022285053](#) [0050291907](#) [018731A](#) [LY20-4P-DT1-P1E-BR](#) [02.125.8002.8](#) [60101931](#) [60598-1 \(Cut Strip\)](#) [M1625-3R/100](#) [61062-3](#) [61082-181009](#) [CSU011177004](#) [636-1427](#) [638009-1](#) [641938-9](#) [641991-4](#) [644168-1](#) [644827-2](#) [647662-1](#) [65039-019ELF](#) [65692-001LF](#) [65781-018](#) [65781-047](#)