



For and on behalf of
XKB INDUSTRIAL PRECISION CO., LIMITED
 香港星洲工業精密有限公司

MARK	DESCRIPTION	DATE	REVISED	APPROVED	UNSPECIFIED TOLERANCES	
					L > 63	±0.5
△ X					16 < L ≤ 63	±0.4
△ X					4 < L ≤ 16	±0.3
△ X					L ≤ 4	±0.2
					ANGULAR	±5°

REVISIONS		UNSPECIFIED TOLERANCES	
REVISION	A0	WEIGHT	1.0g
SHEET	1/1	SHEET	1/1

XKB INDUSTRIAL PRECISION CO., LIMITED

DSND	DATE	SCALE: N/A	MODEL TYPE: X9862H-XXA-N0
APPD	DATE <td>SIZE: A4</td> <td></td>	SIZE: A4	
CHKD	DATE <td>UNIT: mm</td> <td>DWG NO.:</td>	UNIT: mm	DWG NO.:
DWN	DATE <td>VIEW: </td> <td>PART NO.:</td>	VIEW: 	PART NO.:
			1.25mm Crimp Style Connectors

PART NO	Material	Suitable XKB Terminal	Suitable XKB Terminal
X9862H-XXA-N0	PA66 UL 94V-0	X9862T-A	X9862W-A

CKTS	Dimensions (mm)				
	A	B	C	D	E
2	3.36	2.80	1.25	4.30	2.50
3	4.61	4.05	2.55	3.75	3.75
4	5.86	5.30	3.75	6.80	4.85
5	7.11	6.55	5.00	8.05	5.70
6	8.36	7.80	6.25	9.30	5.70
7	9.61	9.05	7.50	10.55	
8	10.86	10.30	8.75	11.80	
9	12.11	11.55	10.00	13.05	
10	13.36	12.80	11.25	14.30	
11	14.61	14.05	12.50	15.55	
12	15.86	15.30	13.75	16.80	
13	17.11	16.55	15.00	18.05	
14	18.36	17.80	16.25	19.30	
15	19.61	19.05	17.50	20.55	
16	20.86	20.30	18.75	21.80	
17	22.11	21.55	20.00	23.05	
18	23.36	22.80	21.25	24.30	
19	24.61	24.05	22.50	25.55	
20	25.86	25.30	23.75	26.80	

7.50

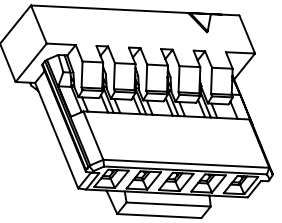
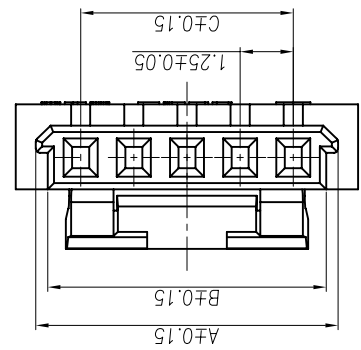
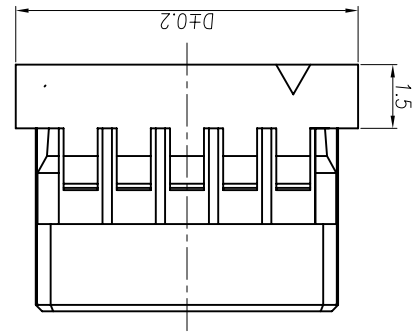
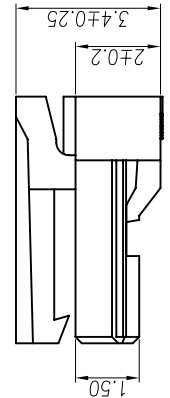
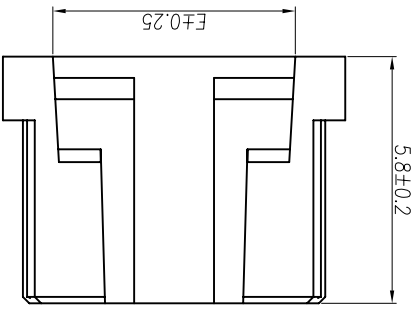

- Specifications :**
- Voltage rating: 200V AC / DC
 - Current rating: 1A AC / DC
 - Withstanding voltage: 500V AC/minute
 - Temperature range: -40°C~+85°C
 - Insulation resistance: ≥100MΩ
 - Contact resistance: ≤40mΩ
 - After environmental testing: ≤80mΩ
- X9862 H X-XX A -N0**
- ① Series No.
 ② Category: H-HSG
 ③ Welding Board Angle: Blank-ordinary
 ④ Row No.-Pin No.: XX-02P-16p
 ⑤ Plug the Pin & special No. A-Ultra-thin
 ⑥ Material: NO-PA66 94V-0

X-ON Electronics

Largest Supplier of Electrical and Electronic Components

Click to view similar products for [Headers & Wire Housings](#) category:

Click to view products by [XKB](#) manufacturer:

Other Similar products are found below :

[95000-104TRLF](#) [10135584-644402LF](#) [DF62W-EP2022PCA](#) [95000-106TRLF](#) [DF62W-2022SCA](#) [DF62W-EP2022PC](#) [2203348](#) [DF62W-2022SC](#) [1084018](#) [1029039](#) [1084017](#) [802-10-012-10-002000](#) [1112640](#) [1112639](#) [891-007-9SS-BST1T](#) [000-34000](#) [0008550134](#) [0009482033](#) [0009507031](#) [57102-F02-18ULF](#) [57102-S06-03LF](#) [57202-S52-04LF](#) [PCN6-15S-2.5E](#) [0039019024](#) [58102-G61-06LF](#) [582553-1](#) [0009485154](#) [0009508121](#) [0022285053](#) [0050291907](#) [018731A](#) [LY20-4P-DT1-P1E-BR](#) [02.125.8002.8](#) [60101931](#) [60598-1 \(Cut Strip\)](#) [M1625-3R/100](#) [61062-3](#) [61082-181009](#) [CSU011177004](#) [636-1427](#) [638009-1](#) [641938-9](#) [641991-4](#) [644168-1](#) [644827-2](#) [647662-1](#) [65039-019ELF](#) [65692-001LF](#) [65781-018](#) [65781-047](#)