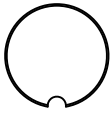
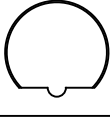
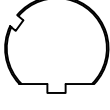

### 1.View and size(视图及尺寸)

Main technical indicators(主要技术指标)	
1.Mating (插拔次数)	>100
2.Working Temperature (温度)	-40~+80 °C
3.IP Rating (防护级别)	IP 67
4.Diameter of socket end(插合端直径)	
5.Rated voltage (额定电压)	30V
6.Rated impulse voltage (额定冲击电压)	800V
7.Rated Current (额定电流)	1.5A
8.Sheathing material(外壳材料)	CuZn( 黄铜镀镍/ Brass nickel plated )
9.Contact material(触点材料)	CuZn( 黄铜/Brass )
10.Insulation(绝缘材料)	PA

Sum up(总结)	
Series(系列)	M8
Shell style/model (外壳样式/型号)	HGG:Fixed receptaCXe, nut fixing, watertight or vacuum-tight/固定插头, 螺母固定, 水密或真空密
Button (按键)	A button(一个按键)
Termination type (终止类型)	Mother solder tin(公焊锡)
Line diameter awg(线材直径)	26AWG-24AWG
Cable diameter φ (电缆直径)	6-8mm
Match plug(匹配插座)	

Location pin combination (定位销组合)		
(编号) Numder	Number of positioning pins(定位销数量)	结构图形
A	1	
B	1	
D	2	

	A	B	C√	ANGLE	
5-10	±0.02	±0.05	±0.1	0°-30°	±0.1°
50-100	±0.1	±0.15	±0.2	61°-90°	±0.5°
50-100	±0.15	±0.2	±0.25		
100-	±0.15%	±0.20%	±0.25%		

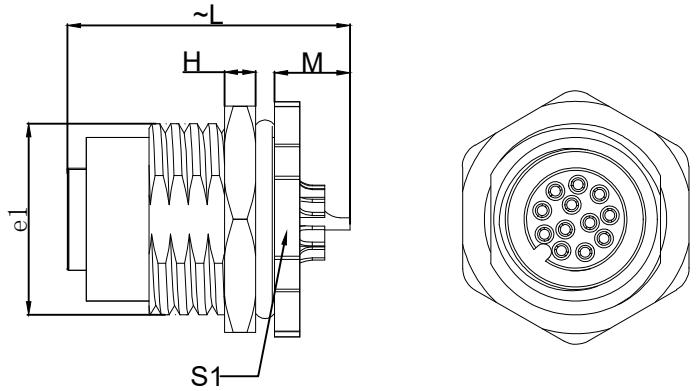

	L	S1	H	M	e1
MM	22.5	18	2.5	6	M16*1.5
in	0.8858	0.7087	0.0984	0.2362	

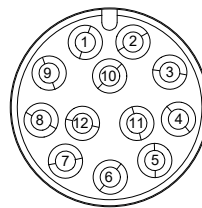

Welded surface (焊接面)

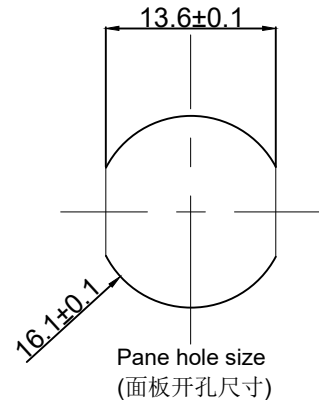

Pane hole size (面板开孔尺寸)

ZG A.M12.P12.N P L

Appearance(外观)

Positioning pin(定位销)

Series(系列)

Needle core configuration(针芯配置)

Outer casing(外壳)

Insulator(绝缘体)

Needle core(针芯)

DESIGNED(设计)		DATE(日期)		SCALE(比例)	N/A(不适用)	MODEL TYPE 型号类型: ZGA.M12.P12.NPL
CHECKED(校对)		DATE(日期)		VIEW(视图)		PART NO. 1B2 core socket 名称: M12A定位12芯母座
APPROVED(审核)		DATE(日期)		UNIT(单位)	MM	DWG NO.:
REVISIONS				MATERIAL (材料)		
www.helloxkb.com www.helloxkb.cn			XKB INDUSTRIAL PRECISION CO.,LIMITED			WEIGHT(重量) SHEET(表) REVISION(修订)
						1/1 A0

## X-ON Electronics

Largest Supplier of Electrical and Electronic Components

*Click to view similar products for [Standard Circular Connector](#) category:*

*Click to view products by [XKB](#) manufacturer:*

Other Similar products are found below :

[600273N007](#) [6134-336-13149](#) [6134-337-11149](#) [6134-337-2390](#) [6134-341-17149](#) [67-02E12-60PX](#) [680-SMG](#) [CXS3102A181S](#)  
[D38999/20FC8SA L/C](#) [75-190216-08S](#) [75-190611-03S](#) [75-474014-05S](#) [75-474618-04S](#) [75-474620-07P](#) [799539-000](#) [805-005-07NF11-19PC](#)  
[805-005-07NF15-7PA](#) [FMP.2M.310.XLCT](#) [836783-1](#) [862256-1](#) [866857-1](#) [867865-1](#) [PT08P-14-19S](#) [PT08P-14-5S](#) [QCM019PC2DC012B](#)  
[121583-0217](#) [121667-0020](#) [RD10A16-19-P6CS051/1](#) [RD16A14-12-S6CS051/2](#) [1301240268](#) [1301240275](#) [1301860906](#) [DCU-08BFEA-](#)  
[LL7001](#) [RM15WTP-CP\(5\)\(71\)](#) [14482](#) [16283-18](#) [1877910-1](#) [206039-3](#) [206323-1](#) [207002-2](#) [207682-1](#) [CA06COME14SA7P](#) [211777-1](#) [JL04-](#)  
[1012CK\(05\)-R](#) [JL04V-2A28-11PE-R](#) [JL04V-2E10SL-3PE-B-R](#) [JL04V-2E20-15PE-B-R](#) [JL04V-2E20-4PE-B-R](#) [JL04V-2E24-10PE\(G\)-B-R](#)  
[JL04V-6A24-11SE-EB-R](#)