

1.View and size(视图及尺寸)

Main technical indicators(主要技术指标)	
1.Mating (插拔次数)	5000
2.Working Temperature (温度)	-55~+150 °C
3.IP Rating (防护级别)	IP 50
4.Diameter of socket end(插合端直径)	φ0.5
5.Testing Voltage (测试电压)	800V
6.Working Voltage (工作电压)	1250V
7.Rated Current (额定电流)	1.5A
8.Shell material(壳体材质)	Brass (chromium plating)/(nickel plating) fixation ring/ 黄铜(镀铬)/(镀镍) 固定圈
9.Pin Material(插针材料)	Copper alloy gold plating(铜合金镀金)
10.Insulator material(绝缘体材质)	L:PPS P:PEEK

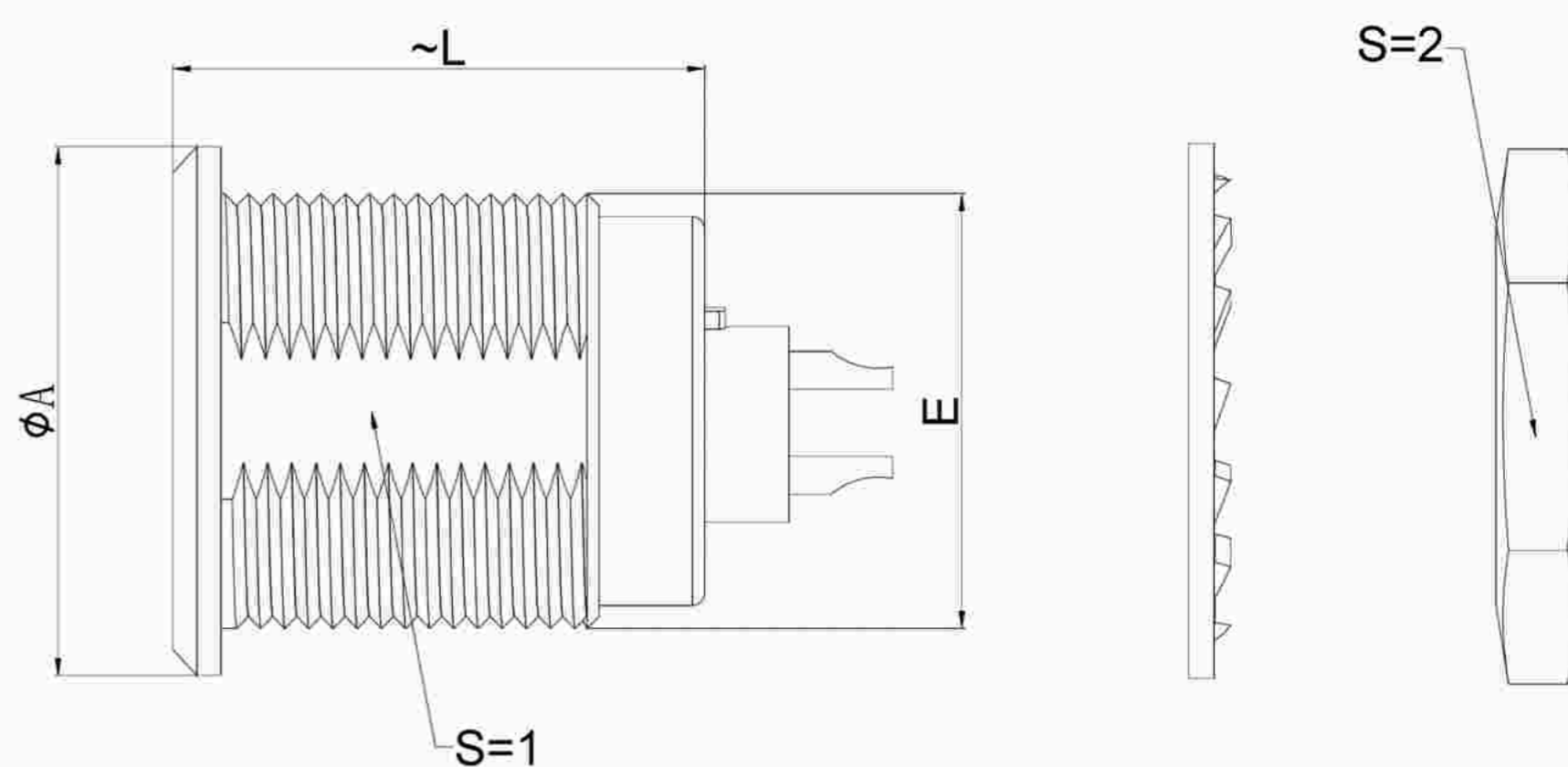

	A	L	E	S1	S2
MM	φ14	16.5	M12*1	10.5	14
in	φ0.55	0.65		0.41	0.55

Sum up(总结)	
Series(系列)	B
Shell style/model (外壳样式/型号)	ZGG:With a nut (post-fixed)带有一个螺母(后固定)
Button (按键)	A button(一个按键)
Termination type (终止类型)	Mother solder tin(母焊锡)
Line diameter awg(线材直径)	34-28AWG
Cable diameterφ (电缆直径)	φ2.3-7.6MM
Match plug(匹配插头)	TGG.1B.P16.CXAD52H



Welded surface (焊接面)

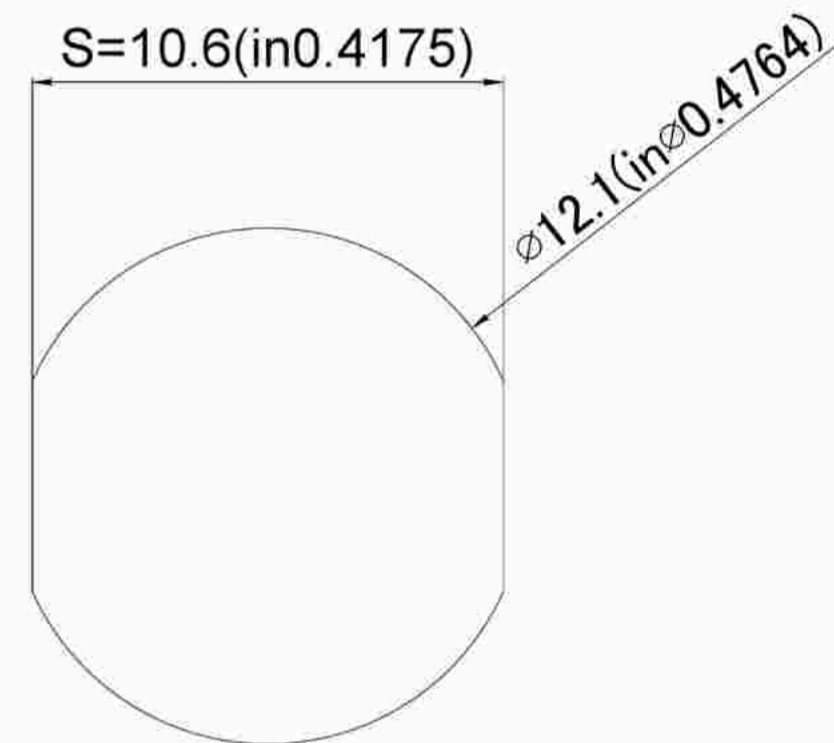

Pane hole size (面板开孔尺寸)

Location pin combination(定位销组合)			
(编号) Numder	Number of positioning pins(定位销数量)	Angle(角度)	Series(系列)--1B
G	One(1)		(Zero degrees)0°
A	Two(2)	A	Thirty degrees(30°)
B	Two(2)		Sixty degrees(60°)
C	Two(2)		Ninety degrees(90°)
D	Two(2)	β	135 degrees(135°)
E	Two(2)		145 degrees(145°)
F	Two(2)		155 degrees(155°)
J	Two(2)	Y	Forty-five degrees(45°)
K	Two(2)		Seventy degrees(70°)
L	Two(2)		80 degrees(80°)

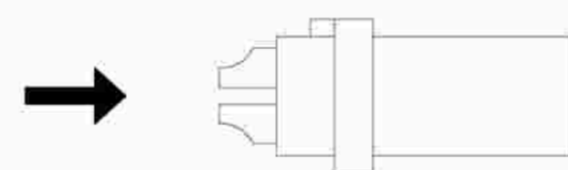

(Welded mother adhesive core) 焊接型母胶芯

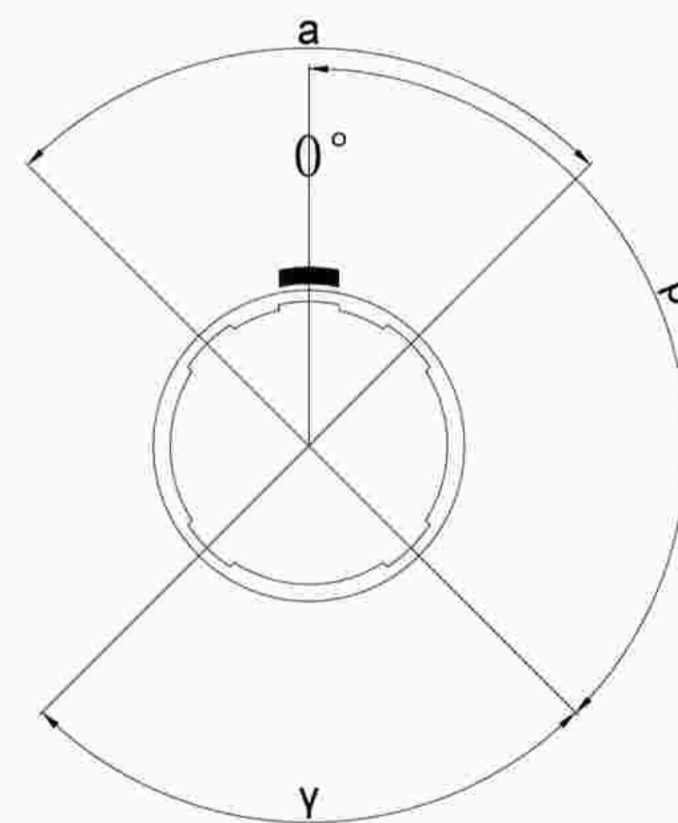

Positive view of the socket (插座正视图)

	A	B	C√	ANGLE	
5-10	±0.02	±0.05	±0.1	0°-30°	±0.1°
50-100	±0.1	±0.15	±0.2	61°-90°	±0.5°
50-100	±0.15	±0.2	±0.25		
100-	±0.15%	±0.20%	±0.25%		

ZG G.1B.P16.C X L

- Model(型号)
- Positioning pin(定位销)
- Series(系列)
- Needle core configuration(针芯配置)
- Outer casing(外壳)
- Insulator(绝缘体)
- Needle core(针芯)

DESIGNED(设计)
广东星坤科技股份有限公司
CHECKED(校对)
APPROVED(审核)
日期
REVISIONS
文件工程章
www.helloxkb.com www.helloxkb.cn

DATE(日期)	
DATE(日期)	
DATE(日期)	

SCALE(比额)	N/A(不适用)
VIEW(视图)	
UNIT(单位)	MM
MATERIAL (材料)	

MODEL TYPE		
型号类型:	ZGG.1B.P16.CXL	
PART NO. 名称:	1B16 core socket 1B16芯插座	
DWG NO.:		
WEIGHT(重量)	SHEET(表)	REVISION(修订)
	1/1	A0

X-ON Electronics

Largest Supplier of Electrical and Electronic Components

Click to view similar products for [Standard Circular Connector](#) category:

Click to view products by [XKB](#) manufacturer:

Other Similar products are found below :

[600273N007](#) [6134-336-13149](#) [6134-337-11149](#) [6134-337-2390](#) [6134-341-17149](#) [67-02E12-60PX](#) [680-SMG](#) [CXS3102A181S](#)
[D38999/20FC8SA L/C](#) [75-190216-08S](#) [75-190611-03S](#) [75-474014-05S](#) [75-474618-04S](#) [75-474620-07P](#) [799539-000](#) [805-005-07NF11-19PC](#)
[805-005-07NF15-7PA](#) [FMP.2M.310.XLCT](#) [836783-1](#) [862256-1](#) [866857-1](#) [867865-1](#) [PT08P-14-19S](#) [PT08P-14-5S](#) [QCM019PC2DC012B](#)
[121583-0217](#) [121667-0020](#) [RD10A16-19-P6CS051/1](#) [RD16A14-12-S6CS051/2](#) [1301240268](#) [1301240275](#) [1301860906](#) [DCU-08BFEA-](#)
[LL7001](#) [RM15WTP-CP\(5\)\(71\)](#) [14482](#) [16283-18](#) [1877910-1](#) [206039-3](#) [206323-1](#) [207002-2](#) [207682-1](#) [CA06COME14SA7P](#) [211777-1](#) [JL04-](#)
[1012CK\(05\)-R](#) [JL04V-2A28-11PE-R](#) [JL04V-2E10SL-3PE-B-R](#) [JL04V-2E20-15PE-B-R](#) [JL04V-2E20-4PE-B-R](#) [JL04V-2E24-10PE\(G\)-B-R](#)
[JL04V-6A24-11SE-EB-R](#)