

# xCORE-200 explorerKIT Hardware Manual

---

## IN THIS DOCUMENT

- ▶ Features
  - ▶ xCORE Multicore Microcontroller Device
  - ▶ GPIO headers (J1 & J3)
  - ▶ Gyroscope and accelerometer
  - ▶ USB connections
  - ▶ RGMII connection
  - ▶ xSYS connector
  - ▶ General purpose push-button switches
  - ▶ Servo connectors
  - ▶ User LEDs
  - ▶ QSPI Flash
  - ▶ 24MHz Crystal Oscillator
  - ▶ Power connector
  - ▶ Operating requirements
  - ▶ Dimensions
  - ▶ xCORE-200 explorerKIT Portmap
  - ▶ xCORE-200 explorerKIT schematics
  - ▶ RoHS and REACH
- 

xCORE-200 explorerKIT is an evaluation board for the configurable xCORE-200 multicore microcontroller products from XMOS. It's easy to use and provides lots of advanced features on a small, extremely low cost platform.

xCORE lets you software-configure the interfaces that you need for your system; so with xCORE-200 explorerKIT you can configure the board to match your exact requirements. The xCORE-200 multicore microcontroller has sixteen 32bit logical cores that deliver up to 2000MIPs completely deterministically, making xCORE-200 explorerKIT an ideal platform for functions ranging from robotics and motion control to networking and digital audio.

## 1 Features

A block diagram of the xCORE-200 explorerKIT is shown below:

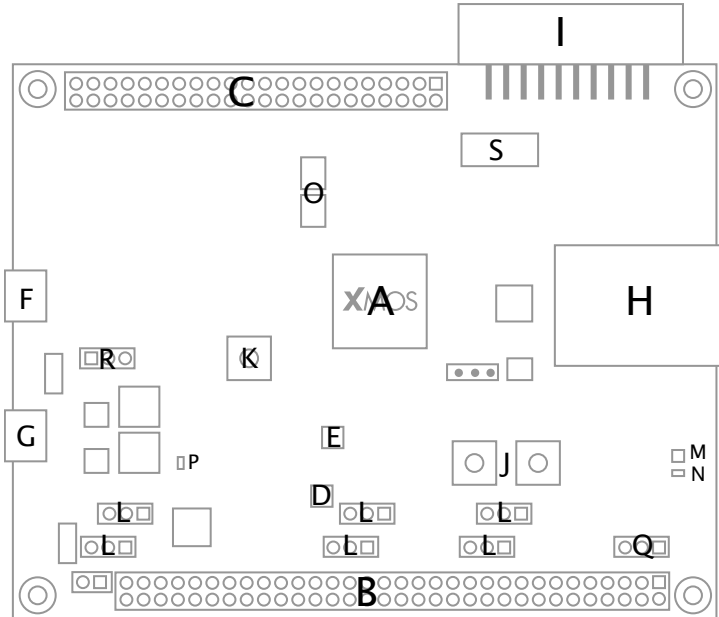

**Figure 1:**  
xCORE-200  
explorerKIT  
block  
diagram

It includes the following features:

- ▶ A: xCORE-200 (XEF216-512-TQ128) Multicore Microcontroller device
- ▶ B: 32 GPIO connections from tile 0, arranged on a 0.1" grid
- ▶ C: 21 GPIO connections from tile 1, arranged on a 0.1" grid
- ▶ D: A BMG160 3-axis gyroscope sensor
- ▶ E: An FXOS8700CQ Digital Sensor - 3D Accelerometer ( $\pm 2g/\pm 4g/\pm 8g$ ) + 3D Magnetometer
- ▶ F: A micro USB connector for connection to a USB device
- ▶ G: A micro USB connector for connection to a power supply
- ▶ H: An RGMII connector for connection to a 10/100/1000Mbps ethernet network
- ▶ I: An xSYS connector for connection to an xTAG debug adapter
- ▶ J: Two general purpose push-button switches
- ▶ K: A reset switch

- ▶ L: Six servo connections
- ▶ M: A general purpose green IED
- ▶ N: A general purpose RGB LED
- ▶ O: A QSPI flash
- ▶ P: A green 3.3v power-good LED
- ▶ Q, R: Two power supply headers
- ▶ S: 24MHz Oscillator

## 2 xCORE Multicore Microcontroller Device

xCORE-200 explorerKIT is based on a two-tile xCORE-200 device (XEF216-512-TQ128). Each tile is user-programmable, providing eight logical cores with a total of up to 1000 MIPS compute. A total of 53 general-purpose digital I/O have been brought out to header pins, providing tremendous flexibility for connecting peripherals to the xCORE-200 explorerKIT board.

For information on xCORE-200 tiles and cores see the xCORE-200 Architecture Overview<sup>1</sup>.

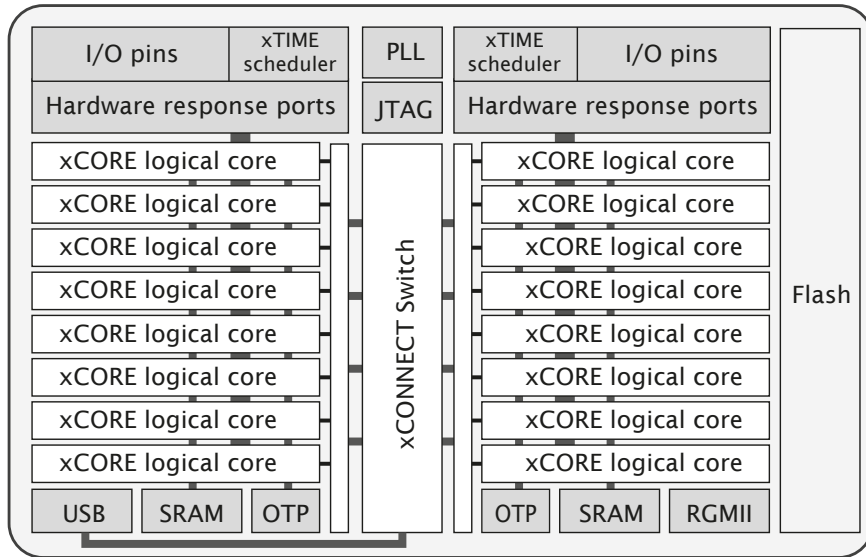
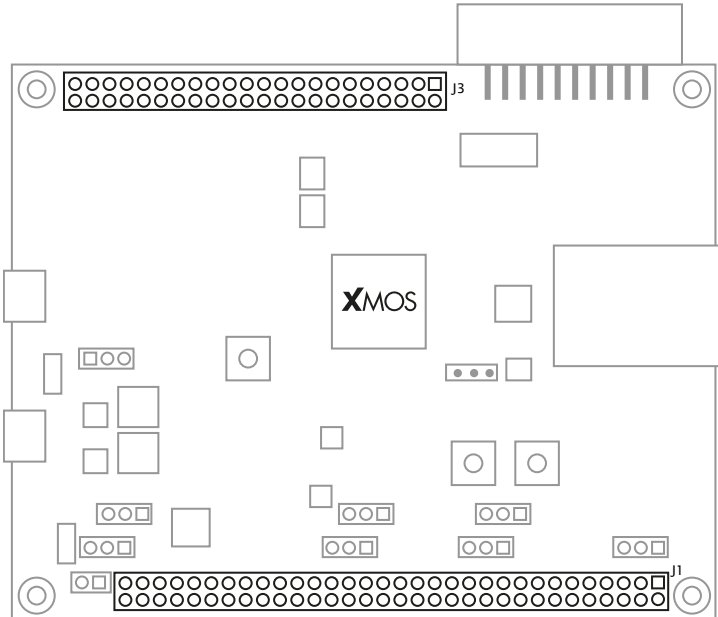

**Figure 2:**  
 xCORE-200  
 XEF216-512-  
 TQ128  
 device

<sup>1</sup><http://www.xmos.com/published/xcore-architecture>

### 3 GPIO headers (J1 & J3)

J1 and J3 provide a rich set of IO that can be readily connected to off-board components.



**Figure 3:**  
GPIO  
connectors

The xCORE ports are mapped to the GPIO connector pins as shown in Figure 4 and Figure 5:

Notes:

- 1 - X0D31 is connected to the red terminal of the general purpose RGB LED (N). This GPIO may be used for other purposes.
- 2 - X0D30 is connected to the green terminal of the general purpose RGB LED (N). This GPIO may be used for other purposes.
- 3 - X0D29 is connected to the blue terminal of the general purpose RGB LED (N). This GPIO may be used for other purposes.
- 4 - X0D28 is connected to the general purpose green LED (M). This GPIO may be used for other purposes.
- 5 - X0D27 is connected to BUTTON B (SW2). This GPIO may be used for other purposes, but care must be taken.
- 6 - X0D26 is connected to BUTTON A (SW1). This GPIO may be used for other purposes, but care must be taken.



Signal	Port	GPIO J1	Signal	GPIO J1
X0D31 <sup>1</sup>	P4F3	1	GND	2
X0D30 <sup>2</sup>	P4F2	3	GND	4
X0D29 <sup>3</sup>	P4F1	5	GND	6
X0D28 <sup>4</sup>	P4F0	7	GND	8
X0D33	P4E3	9	GND	10
X0D32	P4E2	11	GND	12
X0D27 <sup>5</sup>	P4E1	13	GND	14
X0D26 <sup>6</sup>	P4E0	15	GND	16
X0D35	P1L	17	GND	18
X0D34	P1K	19	GND	20
X0D25	P1J	21	GND	22
X0D24	P1I	23	GND	24
X0D19	P4D3	25	GND	26
X0D18	P4D2	27	GND	28
X0D17	P4D1	29	GND	30
X0D16	P4D0	31	GND	32
X0D23	P1H	33	GND	34
X0D22	P1G	35	GND	36
X0D13 <sup>7</sup>	P1F	37	GND	38
X0D12 <sup>8</sup>	P1E	39	GND	40
X0D21	P4C3	41	GND	42
X0D20	P4C2	43	GND	44
X0D15	P4C1	45	GND	46
X0D14	P4C0	47	GND	48
X0D09	P4A3	49	GND	50
X0D08	P4A2	51	GND	52
X0D03	P4A1	53	GND	54
X0D02	P4A0	55	GND	56
X0D39	P1P	57	GND	58
X0D38	P1O	59	GND	60
X0D37	P1N	61	GND	62
X0D36	P1M	63	GND	64

**Figure 4:**  
GPIO J1  
connector ..  
:class:  
horizontal-  
borders

7 - X0D13 is connected to clock (SDA) line of the I2C bus connected to the on-board sensors. A 0R link is provided (R52), so that this connection can be isolated if necessary.

8 - X0D12 is connected to clock (SCL) line of the I2C bus connected to the on-board sensors. A 0R link is provided (R49), so that this connection can be isolated if necessary.

Signal	GPIO J3	Signal	Port	GPIO J3
GND	1	X1D35	P1L	2
GND	3	X1D38	P1O	4
GND	5	X1D39	P1P	6
GND	7	X1D16	P4D0	8
GND	9	X1D17	P4D1	10
GND	11	X1D18	P4D2	12
GND	13	X1D19	P4D3	14
GND	15	X1D14	P4C0	16
GND	17	X1D15	P4C1	18
GND	19	X1D20	P4C2	20
GND	21	X1D21	P4C3	22
GND	23	X1D04	P4B0	24
GND	25	X1D05	P4B1	26
GND	27	X1D06	P4B2	28
GND	29	X1D07	P4B3	30
GND	31	X1D02	P4A0	32
GND	33	X1D03	P4A1	34
GND	35	X1D08	P4A2	36
GND	37	X1D09	P4A3	38
GND	39	X1D00	P1A	40
GND	41	X1D01	P1B	42
GND	43	GND		44

**Figure 5:**  
GPIO J3  
connector

## 4 Gyroscope and accelerometer

The xCORE-200 explorerKIT provides a BMG160 3-axis gyroscope sensor and an FXOS8700CQ Digital Sensor (3D Accelerometer ( $\pm 2g/\pm 4g/\pm 8g$ ) + 3D Magnetometer). These are connected via an I2C interface as described in Figure 7.

**Figure 6:**  
Gyroscope  
and Ac-  
celerometer

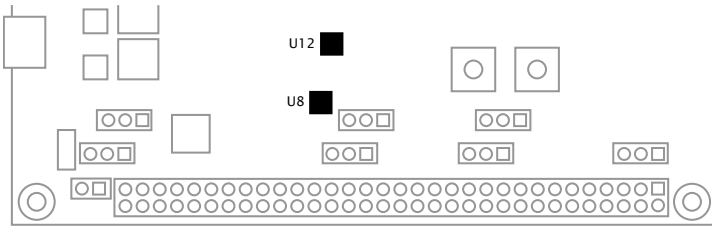

**Figure 7:**  
I2C sensor  
interface

Pin	Port	I2C signal
X0D12	P1E	SCL
X0D13	P1F	SDA

## 5 USB connections

Two micro-USB (B-type) connections are provided:

**Figure 8:**  
USB  
connectors

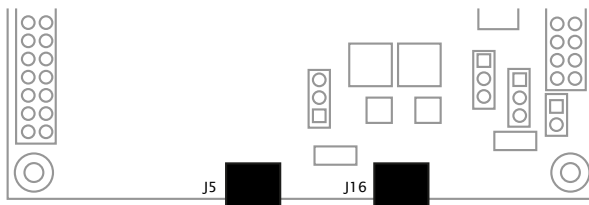

Note that J16 must be connected at all times, to provide power to the xCORE-200 explorerKIT. J5 should also be connected when developing USB applications.

## 6 RGMII connection

An RJ45 connector is available for the development of 10/100/1000 Mbps ethernet applications.

**Figure 9:**  
10/100/1000  
Ethernet  
connector

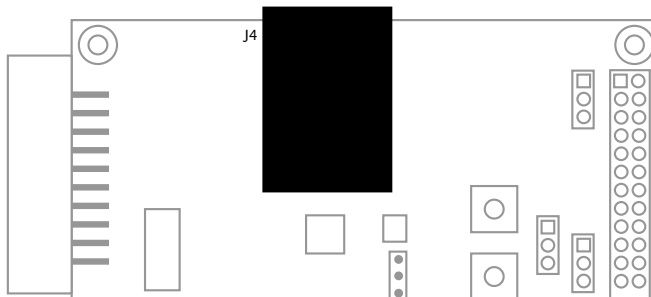

## 7 xSYS connector

The xSYS connector is provided to interface to an xTAG debug adapter. The xTAG debug adapter allows the xTIMEcomposer tools to interrogate the application running on the xCORE-200 device using the XMOS debugger and the xSCOPE library which provides non-intrusive program instrumentation.

## 8 General purpose push-button switches

Two general purpose push-button switches are provided as shown below. When depressed, the push-buttons create a connection from the IO to GND. Care must be taken to ensure that this does not cause undesirable behaviour on the xCORE-200 or other components connected through the GPIO headers:

**Figure 10:**  
General purpose push-button switches

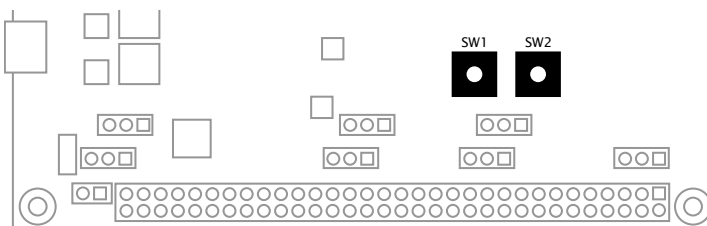

Each push-button switch is connected to a different IO on the xCORE-200 device as described in Figure 11:

**Figure 11:**  
General purpose push-button switches

Pin	Port	BUTTON
X0D26	P4E0	SW1
X0D27	P4E1	SW2

## 9 Servo connectors

Up to six servos can be connected to the xCORE-200 explorerKIT using the header sockets provided. Note that it is up to the user to ensure that sufficient supply power is available to drive the servos.

**Figure 12:**  
Servo connectors

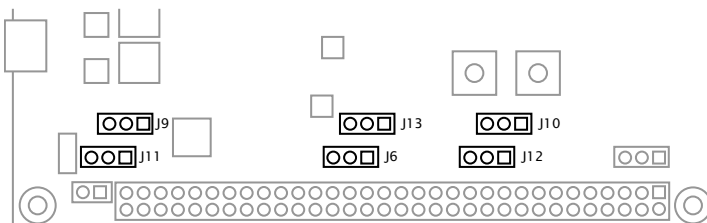

Connector	Pin 1	Port	Pin 2	Pin 3
J8	X0D22	P1G	+5V	GND
J9	X0D37	P1N	+5V	GND
J10	X0D35	P1L	+5V	GND
J11	X0D36	P1M	+5V	GND
J12	X0D34	P1K	+5V	GND
J13	X0D23	P1H	+5V	GND

**Figure 13:**  
GPIO servo connector

## 10 User LEDs

xCORE-200 explorerKIT provides two LEDs, a green LED and an RGD LED arranged as shown below:

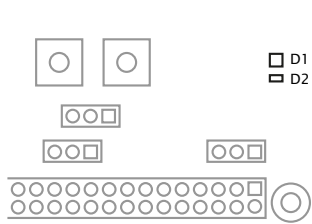

**Figure 14:**  
User LEDs

The green LED and each colour terminal of the RGB LED are connected to a different pin as described in Figure 15:

Pin	Port	LED
X0D28	P4F0	Green
X0D29	P4F1	RGB (blue term)
X0D30	P4F2	RGB (green term)
X0D31	P4F3	RGB (red term)

**Figure 15:**  
User LEDs

## 11 QSPI Flash

xCORE-200 explorerKIT provides 1Mbytes of Quad Serial Peripheral Interface (QSPI) FLASH memory, which is interfaced by the GPIO connections shown in Figure 16:

The xTIMEcomposer tools include the xFLASH utility for programming compiled programs into the flash memory. xCORE-200 explorerKIT designs may also access the FLASH memory at run-time by interfacing with the above pins.

Pin	Port	QSPI connection
X0D01	P1A	CE_n
X0D04	P4B0	IO0
X0D05	P4B1	IO1
X0D06	P4B2	IO2
X0D07	P4B3	IO3
X0D10	P1C	SPI_CLK

**Figure 16:**  
QSPI Flash

## 12 24MHz Crystal Oscillator

The xCORE-200 explorerKIT board is clocked at 24MHz by a crystal oscillator. Each tile is clocked at 500 MIPS, and all I/O ports are 100MHz.

## 13 Power connector

xCORE-200 explorerKIT requires a 5V power source input via the micro-USB cable.



**Figure 17:**  
Power connection via micro-USB

The voltage is converted by the on-board regulator to the 1V and 3V3 supplies used by the components. Additional or alternative power sources may use the power headers provided as shown in Figure 18:

Connector	Pin 1	Pin 2	Pin 3
J14	+5V	+3.3V	GND
J15	+5V	+3.3V	GND

**Figure 18:**  
Power connectors

See the *Operating requirements* section §14 for further information.

## 14 Operating requirements

A USB 2.0 high-speed compliant cable of less than 3m in length should be used when operating the xCORE-200 explorerKIT. XMOS cannot guarantee correct operation of the xCORE-200 explorerKIT should any other cable be used.

This product is, like most electronic equipment, sensitive to Electrostatic Discharge (ESD) events. Users should operate the xCORE-200 explorerKIT with appropriate ESD precautions in place.

## 15 Dimensions

The xCORE-200 explorerKIT dimensions are 105 x 80mm. The mounting holes are 2mm in diameter.

## 16 xCORE-200 explorerKIT Portmap

The table below provides a full description of the port-pin mappings described throughout this document.

Pin	link	1-bit	4-bit	8-bit	16-bit	32-bit	GPIO	SPI	BUTTON	LED	uplink	RGMI
X0D00		1A <sup>0</sup>						MISO				
X0D01	D <sup>2</sup> out	1B <sup>0</sup>						CS				
X0D02			4A <sup>0</sup>	8A <sup>0</sup>	16A <sup>0</sup>	32A <sup>20</sup>	J1 <sup>55</sup>					
X0D03			4A <sup>1</sup>	8A <sup>1</sup>	16A <sup>1</sup>	32A <sup>21</sup>	J1 <sup>53</sup>					
X0D04			4B <sup>0</sup>	8A <sup>2</sup>	16A <sup>2</sup>	32A <sup>22</sup>		D0				
X0D05			4B <sup>1</sup>	8A <sup>3</sup>	16A <sup>3</sup>	32A <sup>23</sup>		D1				
X0D06			4B <sup>2</sup>	8A <sup>4</sup>	16A <sup>4</sup>	32A <sup>24</sup>		D2				
X0D07			4B <sup>3</sup>	8A <sup>5</sup>	16A <sup>5</sup>	32A <sup>25</sup>		D3				
X0D08			4A <sup>2</sup>	8A <sup>6</sup>	16A <sup>6</sup>	32A <sup>26</sup>	J1 <sup>51</sup>					
X0D09			4A <sup>3</sup>	8A <sup>7</sup>	16A <sup>7</sup>	32A <sup>27</sup>	J1 <sup>49</sup>					
X0D10	D <sup>3</sup> out	1C <sup>0</sup>						CLK				
X0D11		1D <sup>0</sup>						MOSI				
X0D12		1E <sup>0</sup>					J1 <sup>39</sup>					
X0D13		1F <sup>0</sup>					J1 <sup>37</sup>					
X0D14			4C <sup>0</sup>	8B <sup>0</sup>	16A <sup>8</sup>	32A <sup>28</sup>	J1 <sup>47</sup>					
X0D15			4C <sup>1</sup>	8B <sup>1</sup>	16A <sup>9</sup>	32A <sup>29</sup>	J1 <sup>45</sup>					
X0D16	E <sup>4</sup> in		4D <sup>0</sup>	8B <sup>2</sup>	16A <sup>10</sup>		J1 <sup>31</sup>					
X0D17	E <sup>3</sup> in		4D <sup>1</sup>	8B <sup>3</sup>	16A <sup>11</sup>		J1 <sup>29</sup>					
X0D18	E <sup>2</sup> in		4D <sup>2</sup>	8B <sup>4</sup>	16A <sup>12</sup>		J1 <sup>27</sup>					
X0D19	E <sup>1</sup> in		4D <sup>3</sup>	8B <sup>5</sup>	16A <sup>13</sup>		J1 <sup>25</sup>					
X0D20			4C <sup>2</sup>	8B <sup>6</sup>	16A <sup>14</sup>	32A <sup>30</sup>	J1 <sup>43</sup>					
X0D21			4C <sup>3</sup>	8B <sup>7</sup>	16A <sup>15</sup>	32A <sup>31</sup>	J1 <sup>41</sup>					
X0D22		1G <sup>0</sup>					J1 <sup>35</sup>					
X0D23		1H <sup>0</sup>					J1 <sup>33</sup>					
X0D24	H <sup>0</sup> in	1I <sup>0</sup>					J1 <sup>23</sup>					
X0D25	H <sup>0</sup> out	1J <sup>0</sup>					J1 <sup>21</sup>					
X0D26	H <sup>3</sup> out		4E <sup>0</sup>	8C <sup>0</sup>	16B <sup>0</sup>		J1 <sup>15</sup>		A			
X0D27	H <sup>4</sup> out		4E <sup>1</sup>	8C <sup>1</sup>	16B <sup>1</sup>		J1 <sup>13</sup>		B			
X0D28			4F <sup>0</sup>	8C <sup>2</sup>	16B <sup>2</sup>		J1 <sup>7</sup>					Green
X0D29			4F <sup>1</sup>	8C <sup>3</sup>	16B <sup>3</sup>		J1 <sup>5</sup>					RGB <sup>B</sup>
X0D30			4F <sup>2</sup>	8C <sup>4</sup>	16B <sup>4</sup>		J1 <sup>3</sup>					RGB <sup>G</sup>
X0D31			4F <sup>3</sup>	8C <sup>5</sup>	16B <sup>5</sup>		J1 <sup>1</sup>					RGB <sup>R</sup>
X0D32			4E <sup>2</sup>	8C <sup>6</sup>	16B <sup>6</sup>		J1 <sup>11</sup>					
X0D33			4E <sup>3</sup>	8C <sup>7</sup>	16B <sup>7</sup>		J1 <sup>9</sup>					
X0D34	H <sup>1</sup> out	1K <sup>0</sup>					J1 <sup>19</sup>					
X0D35	H <sup>2</sup> out	1L <sup>0</sup>					J1 <sup>17</sup>					
X0D36		1M <sup>0</sup>		8D <sup>0</sup>	16B <sup>8</sup>		J1 <sup>63</sup>					
X0D37	A <sup>4</sup> in	1N <sup>0</sup>		8D <sup>1</sup>	16B <sup>9</sup>		J1 <sup>61</sup>					
X0D38	A <sup>3</sup> in	1O <sup>0</sup>		8D <sup>2</sup>	16B <sup>10</sup>		J1 <sup>59</sup>					
X0D39	A <sup>2</sup> in	1P <sup>0</sup>		8D <sup>3</sup>	16B <sup>11</sup>		J1 <sup>57</sup>					
X0D40	A <sup>1</sup> in			8D <sup>4</sup>	16B <sup>12</sup>							DN1
X0D41	A <sup>0</sup> in			8D <sup>5</sup>	16B <sup>13</sup>							DN0
X0D42	A <sup>0</sup> out			8D <sup>6</sup>	16B <sup>14</sup>							UPO
X0D43	A <sup>1</sup> out			8D <sup>7</sup>	16B <sup>15</sup>							UPI

**Figure 19:**  
xCORE-200  
explorerKIT  
Portmap



Pin	link	1-bit	4-bit	8-bit	16-bit	32-bit	GPIO	SPI	BUTTON	LED	uplink	RGMI
X1D00	H <sup>2</sup> in	1A <sup>0</sup>					J3 <sup>40</sup>					
X1D01	H <sup>1</sup> in	1B <sup>0</sup>					J3 <sup>42</sup>					
X1D02	E <sup>0</sup> in		4A <sup>0</sup>	8A <sup>0</sup>	16A <sup>0</sup>	32A <sup>20</sup>	J3 <sup>32</sup>					
X1D03	E <sup>0</sup> out		4A <sup>1</sup>	8A <sup>1</sup>	16A <sup>1</sup>	32A <sup>21</sup>	J3 <sup>34</sup>					
X1D04	E <sup>1</sup> out		4B <sup>0</sup>	8A <sup>2</sup>	16A <sup>2</sup>	32A <sup>22</sup>	J3 <sup>24</sup>					
X1D05	E <sup>2</sup> out		4B <sup>1</sup>	8A <sup>3</sup>	16A <sup>3</sup>	32A <sup>23</sup>	J3 <sup>26</sup>					
X1D06	E <sup>3</sup> out		4B <sup>2</sup>	8A <sup>4</sup>	16A <sup>4</sup>	32A <sup>24</sup>	J3 <sup>28</sup>					
X1D07	E <sup>4</sup> out		4B <sup>3</sup>	8A <sup>5</sup>	16A <sup>5</sup>	32A <sup>25</sup>	J3 <sup>30</sup>					
X1D08	H <sup>4</sup> in		4A <sup>2</sup>	8A <sup>6</sup>	16A <sup>6</sup>	32A <sup>26</sup>	J3 <sup>36</sup>					
X1D09	H <sup>3</sup> in		4A <sup>3</sup>	8A <sup>7</sup>	16A <sup>7</sup>	32A <sup>27</sup>	J3 <sup>38</sup>					
X1D10		1C <sup>0</sup>										MDIO
X1D11		1D <sup>0</sup>										MDC
X1D14			4C <sup>0</sup>	8B <sup>0</sup>	16A <sup>8</sup>	32A <sup>28</sup>	J3 <sup>16</sup>					
X1D15			4C <sup>1</sup>	8B <sup>1</sup>	16A <sup>9</sup>	32A <sup>29</sup>	J3 <sup>18</sup>					
X1D16	D <sup>1</sup> in		4D <sup>0</sup>	8B <sup>2</sup>	16A <sup>10</sup>		J3 <sup>8</sup>					
X1D17	D <sup>0</sup> in		4D <sup>1</sup>	8B <sup>3</sup>	16A <sup>11</sup>		J3 <sup>10</sup>					
X1D18	D <sup>0</sup> out		4D <sup>2</sup>	8B <sup>4</sup>	16A <sup>12</sup>		J3 <sup>12</sup>					
X1D19	D <sup>1</sup> out		4D <sup>3</sup>	8B <sup>5</sup>	16A <sup>13</sup>		J3 <sup>14</sup>					
X1D20			4C <sup>2</sup>	8B <sup>6</sup>	16A <sup>14</sup>	32A <sup>30</sup>	J3 <sup>20</sup>					
X1D21			4C <sup>3</sup>	8B <sup>7</sup>	16A <sup>15</sup>	32A <sup>31</sup>	J3 <sup>22</sup>					
X1D26		4E <sup>0</sup>	8C <sup>0</sup>	16B <sup>0</sup>								TX_CLK
X1D27		4E <sup>1</sup>	8C <sup>1</sup>	16B <sup>1</sup>								TX_EN
X1D28		4F <sup>0</sup>	8C <sup>2</sup>	16B <sup>2</sup>								RX_CLK
X1D29		4F <sup>1</sup>	8C <sup>3</sup>	16B <sup>3</sup>								RX_DV
X1D30			4F <sup>2</sup>	8C <sup>4</sup>	16B <sup>4</sup>							RX0
X1D31			4F <sup>3</sup>	8C <sup>5</sup>	16B <sup>5</sup>							RX1
X1D32			4E <sup>2</sup>	8C <sup>6</sup>	16B <sup>6</sup>							RX2
X1D33			4E <sup>3</sup>	8C <sup>7</sup>	16B <sup>7</sup>							RX3
X1D35	A <sup>3</sup> out	1L <sup>0</sup>					J3 <sup>2</sup>					
X1D36	A <sup>4</sup> out	1M <sup>0</sup>		8D <sup>0</sup>	16B <sup>8</sup>							INT
X1D37	D <sup>4</sup> in	1N <sup>0</sup>		8D <sup>1</sup>	16B <sup>9</sup>							PHY_RSTn
X1D38	D <sup>3</sup> in	1O <sup>0</sup>		8D <sup>2</sup>	16B <sup>10</sup>		J3 <sup>4</sup>					
X1D39	D <sup>2</sup> in	1P <sup>0</sup>		8D <sup>3</sup>	16B <sup>11</sup>		J3 <sup>6</sup>					
X1D40				8D <sup>4</sup>	16B <sup>12</sup>							TX3
X1D41				8D <sup>5</sup>	16B <sup>13</sup>							TX4
X1D42				8D <sup>6</sup>	16B <sup>14</sup>							TX5
X1D43				8D <sup>7</sup>	16B <sup>15</sup>							TX6

**Figure 20:**  
xCORE-200  
explorerKIT  
Portmap

# 17 xCORE-200 explorerKIT schematics

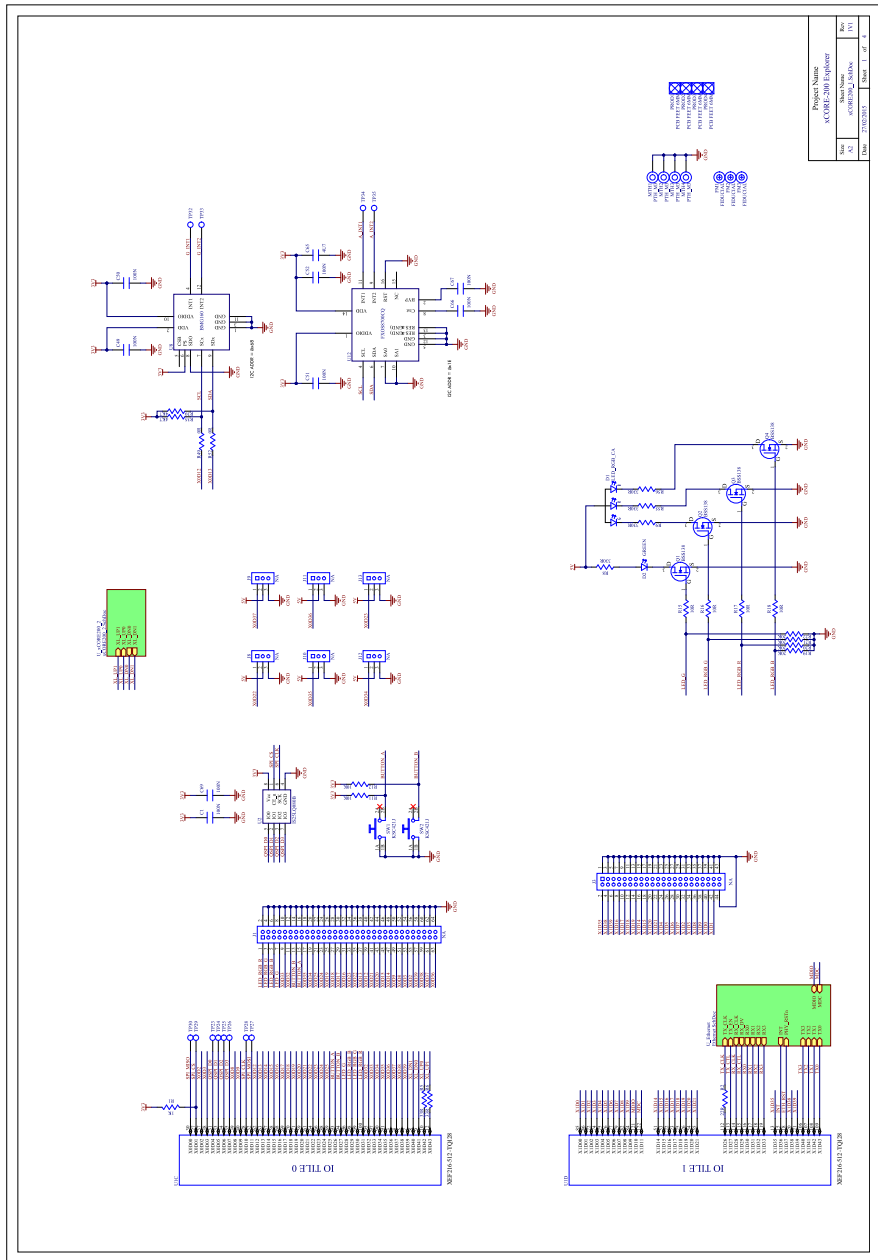

**Figure 21:**  
xCORE-200  
explorerKIT  
schematic







## 18 RoHS and REACH

The xCORE-200 explorerKIT complies with appropriate RoHS2 and REACH regulations and is a Pb-free product.

The xCORE-200 explorerKIT is subject to the European Union WEEE directive and should not be disposed of in household waste. Alternative requirements may apply outside of the EU.



Copyright © 2015, All Rights Reserved.

---

Xmos Ltd. is the owner or licensee of this design, code, or Information (collectively, the "Information") and is providing it to you "AS IS" with no warranty of any kind, express or implied and shall have no liability in relation to its use. Xmos Ltd. makes no representation that the Information, or any particular implementation thereof, is or will be free from any claims of infringement and again, shall have no liability in relation to any such claims.

## **X-ON Electronics**

Largest Supplier of Electrical and Electronic Components

*Click to view similar products for [xmos](#) manufacturer:*

Other Similar products are found below :

[XK-EVK-XE216](#) [XEF232-1024-FB374-C40](#) [XK-AUDIO-216-MC-AB](#) [XS1-L6A-64-LQ64-C5](#) [XS1-L8A-64-LQ64-C5](#) [XA-XTAG](#) [XU208-256-TQ64-C10](#) [XEF216-512-FB236-C20](#)