

# EMA212 Series



- 3.00" x 5.00" x 1.34"
- High Power Density 10.6 W/in<sup>3</sup>
- Up to 90% Efficiency
- 5 V Standby & 12 V Fan Outputs
- Active Current Share
- Remote On/Off
- Power Good Signal
- -10 °C to +70 °C Operation
- Universal AC Input 90–264 VAC
- Level B Conducted Emissions
- 48 VDC Input Versions Available (DMA212)

Designed for communications applications, the EMA212 has been developed to meet the needs of networking equipment, voice over IP systems, wireless LANs, servers, storage area networks and post-production broadcast equipment. Designers of these systems demand higher power from AC/DC units in industry-standard 1U formats as processing power and functionality grows within tight space constraints. The EMA212 delivers over 200W across the full universal AC input range from an industry-standard 3 x 5 inch (76.2 x 127 mm) footprint. It is 1.34 inches (34.04 mm) high and achieves 10.6 Watts per cubic inch power density without compromising performance or functionality.

With efficiency up to 90% at full load, the EMA212 needs only 12 CFM air-flow for full power operation at up to 50 °C ambient and will operate at up to 70 °C ambient with de-rating. The main output is 12, 24 or 48 VDC but each power supply also has a 5 V, 100 mA standby output and a 12 V, 1 A output for powering a fan. The unit incorporates a fully featured signal set including AC fail/DC OK, remote on/off and active current sharing.

## Models and Ratings

Max Output Power (12 CFM Air Flow)	Output Voltage V1	Output Current (12 CFM Airflow)	Fan Output V2	Standby Supply V3	Model Number
212 W	12.0VDC	16.7 A	12.0 V/1.0 A	5.0 V/0.1 A	EMA212PS12
212 W	24.0VDC	8.3 A	12.0 V/1.0 A	5.0 V/0.1 A	EMA212PS24
205 W	48.0VDC	4.0 A	12.0 V/1.0 A	5.0 V/0.1 A	EMA212PS48

## Input Characteristics

Characteristic	Minimum	Typical	Maximum	Units	Notes & Conditions
Input Voltage - Operating	90		264	VAC	
Input Frequency	47	50/60	63	Hz	
Power Factor		>0.9			230 VAC
Input Current - No Load		110		mA	
Input Current - Full Load		2.1/1.1		A	115/230 VAC
Inrush Current			60	A	230 VAC cold start
Earth Leakage Current		0.5	1.1	mA	230/264 VAC 50 Hz
Input Protection	T5 A/250 V internal fuse in line				

## Output Characteristics

Characteristic	Minimum	Typical	Maximum	Units	Notes & Conditions
Output Voltage - V1	12		48	VDC	See Models and Ratings table
Initial Set Accuracy			$\pm 1^{(V1)}$ , $\pm 5^{(V2)}$ & $\pm 3^{(V3)}$	%	
Output Voltage Adjustment					Not available
Minimum Load					No minimum load required
Start Up Delay		1.5	3	s	90 VAC full load (see fig. 1 to 3)
Start Up Rise Time			20	ms	
Hold Up Time	16	20		ms	90 VAC full load (see fig. 4 to 6)
Drift			$\pm 0.2$	%	After 20 min warm up
Line Regulation			$\pm 0.5^{(V1)}$ , $\pm 2^{(V2)}$ & $\pm 0.5^{(V3)}$	%	
Load Regulation			$\pm 1^{(V1)}$ , $\pm 5^{(V2)}$ & $\pm 1^{(V3)}$	%	0-100% load V1 & V3, 10-100% load V2
Cross Regulation			$\pm 10^{(V2)}$	%	10-100% load change V1
Transient Response - V1			4	%	Recovery within 1% in less than 500 $\mu$ s for a 25-75% and 75-25% load step (see fig. 7 & 8)
Over/Undershoot - V1			2/5	%	12/48 V (see fig. 9)
Ripple & Noise			$1^{(V1)}$ & $3^{(V3)}$ & $2^{(V2)}$	% pk-pk	20 MHz bandwidth (see fig. 11 to 14)
Overvoltage Protection	115		140	%	Vnom DC. Output 1 only, recycle input to reset
Overload Protection	110		140	% I nom	Output 1 only, auto reset (see fig. 10)
Short Circuit Protection					Trip & Restart (Hiccup mode)
Temperature Coefficient			0.05	%/°C	
Overtemperature Protection				°C	Primary & secondary protection

## Start Up Delay From AC Turn On

- KEY
- ① AC
  - ② V1
  - ③ V FAN V2
  - ④ V STANDBY V3

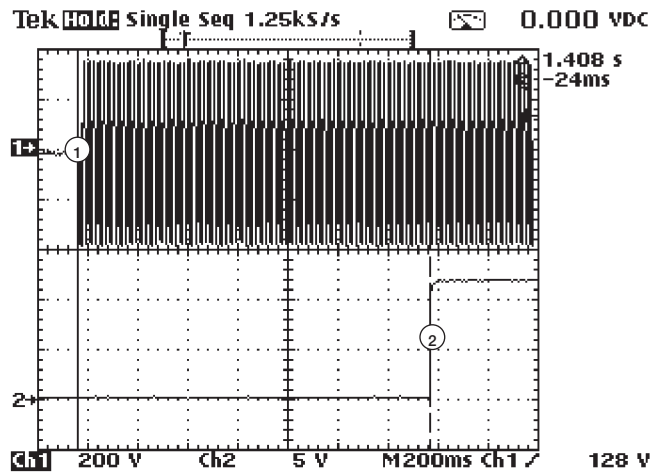

Figure 1  
V1 (full load) - 1.40 s

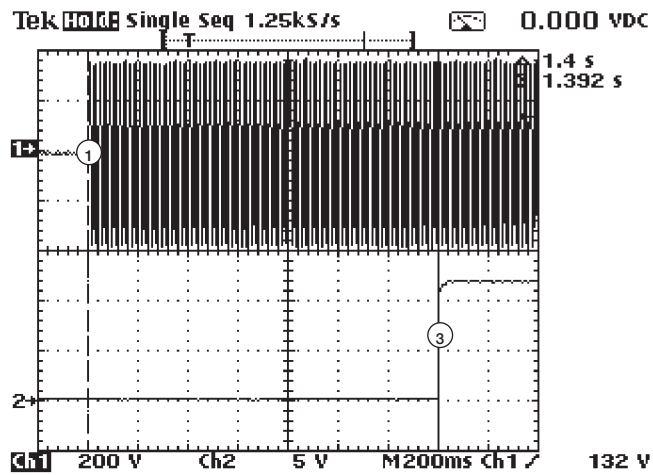

Figure 2  
V2 (full load) - 1.45 s

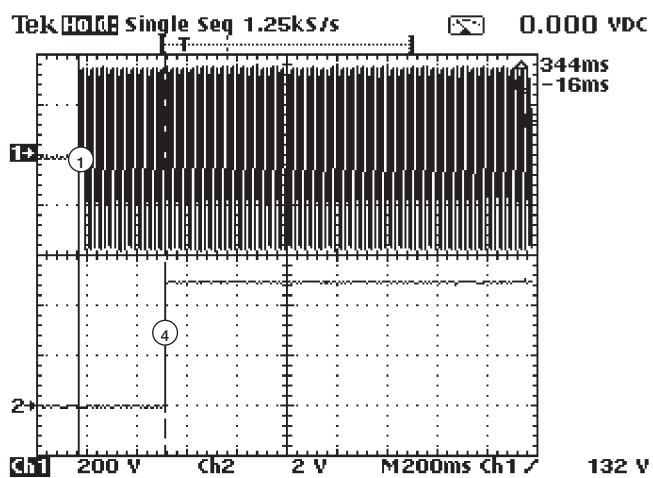

Figure 3  
V3 (full load) - 344 ms

## Hold Up Time From Loss Of AC

KEY  
 ① AC

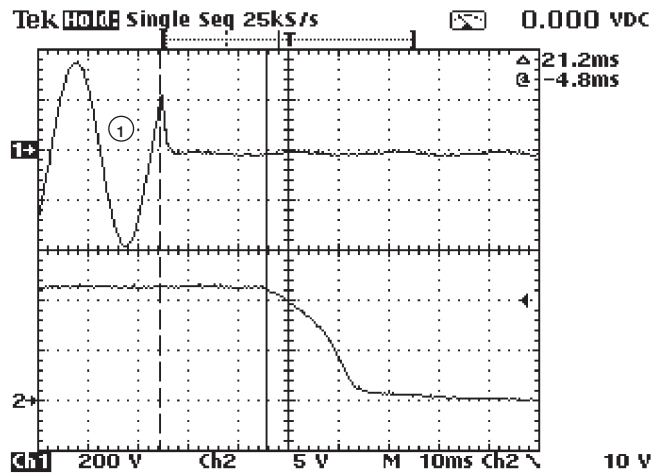

Figure 4

V1 21.2 ms (Full load at 90 VAC input)

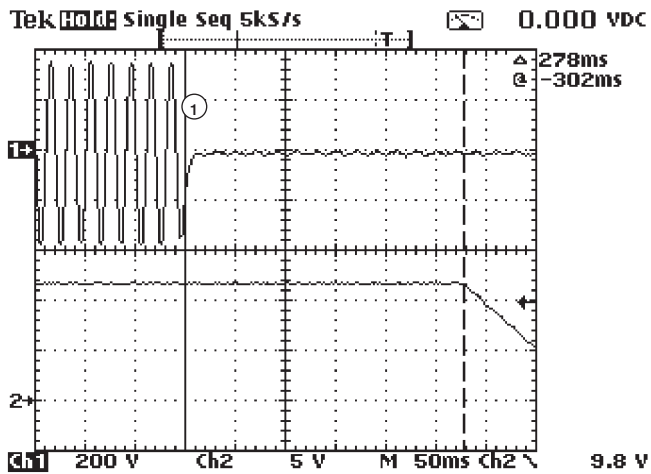

Figure 5

V2 278 ms (Full load at 90 VAC input)

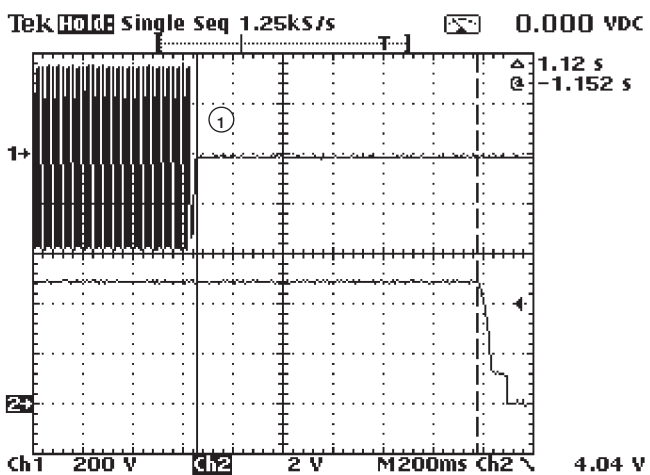

Figure 6

V3 1.12 s (Full load at 90 VAC input)

## Output Transient Response 25-75% & 75-25% Load Step

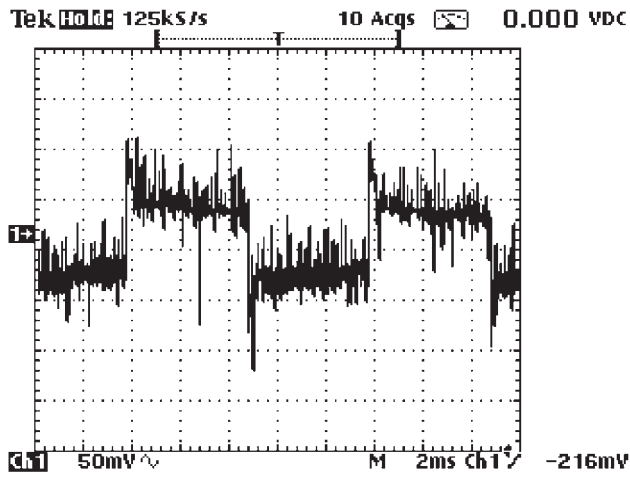

Figure 7  
EMA212PS12

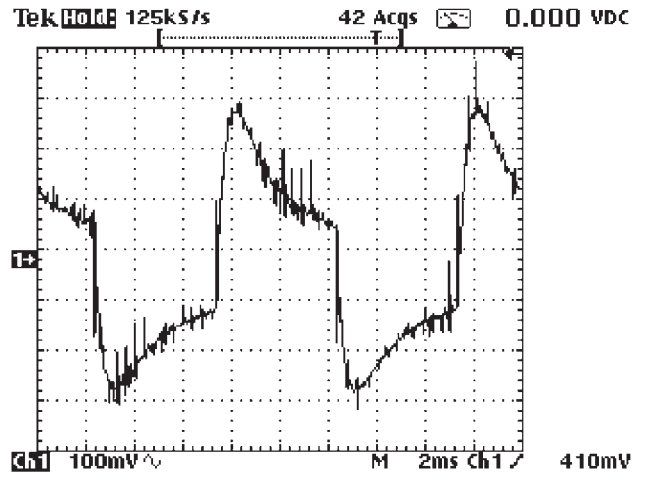

Figure 8  
EMA212PS48

## Output Overshoot

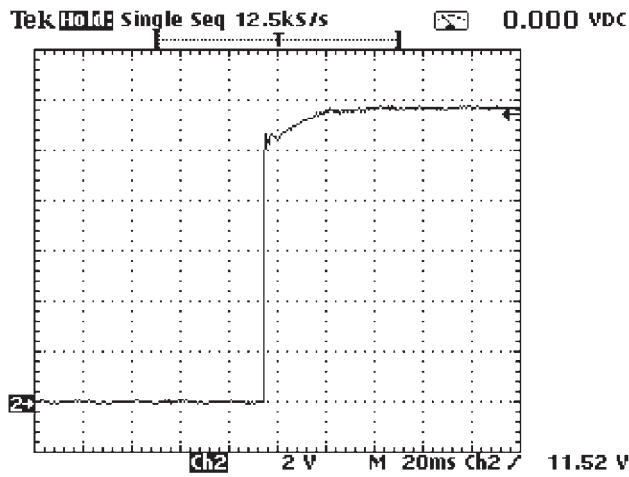

Figure 9  
Typical Output Overshoot

## Output Overload Characteristic

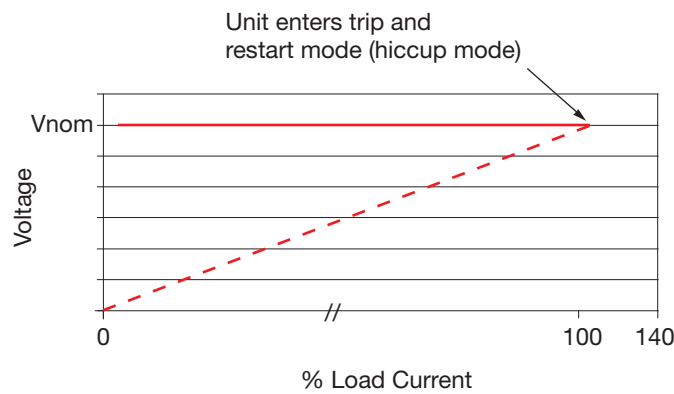
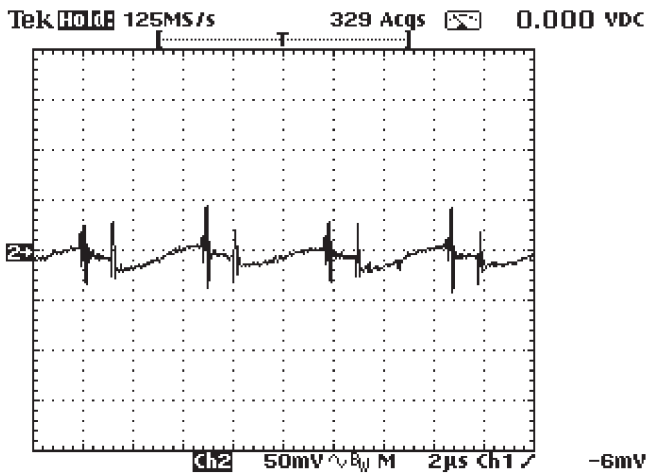
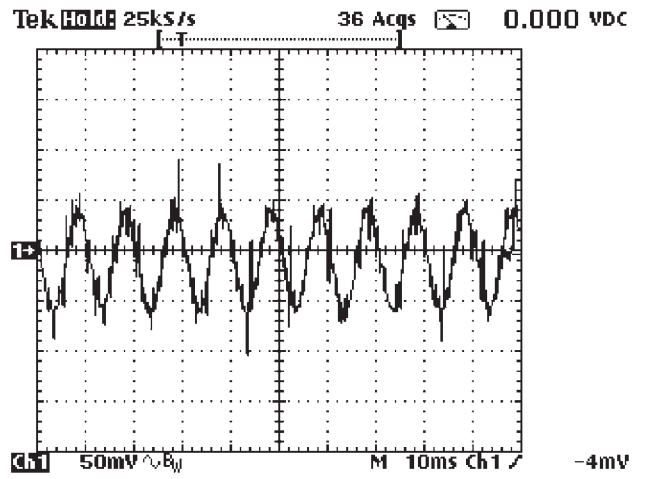

Figure 10  
Typical Overload Characteristic

## Output Ripple & Noise



**Figure 11**  
 V1 EMA212PS12 (Full load).  
 80 mV pk-pk Ripple. 20 MHz BW



**Figure 12**  
 V1 EMA212PS48 (Full load).  
 180 mV pk-pk Ripple. 20 MHz BW

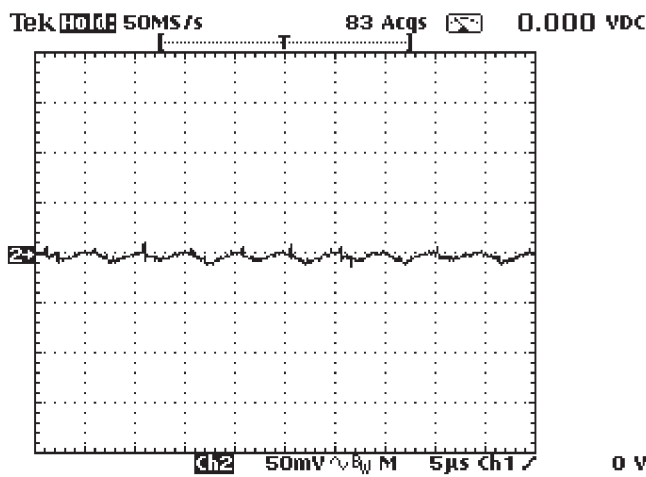

**Figure 13**  
 V2 (Full load).  
 < 25 mV pk-pk Ripple. 20 MHz BW

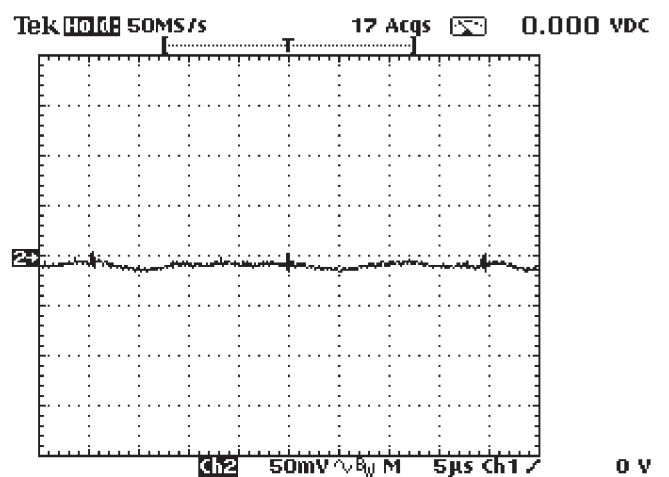

**Figure 14**  
 V3 (Full load).  
 < 25 mV pk-pk Ripple. 20 MHz BW

## General Specifications

Characteristic	Minimum	Typical	Maximum	Units	Notes & Conditions
Efficiency		88		%	Full load 230 VAC (see fig. 15 & 16)
Isolation: Input to Output	3000			VAC	
	1500			VAC	
	500			VDC	
Switching Frequency: PFC Main Converter		80		kHz	
		100		kHz	
Power Density			10.6	W/in <sup>3</sup>	
Mean Time Between Failure		212		kHrs	MIL-HDBK-217F, ground benign at 25°C.
Weight			0.66 (300)	lb (g)	

Characteristic	Notes & Conditions
<b>Signals</b>	
Combined Power Fail & DC OK	Open collector referenced to output 0V, transistor normally off when AC & output good. Power Fail: Provides ≥ 5 ms warning of loss of output from AC failure. DC OK: Provides warning of DC output failure (see fig. 17 to fig 27)
Remote On/Off	Uncommitted isolated opto-coupler diode - powered diode inhibits the supply.
Current Share	For increased power, up to 3 supplies can be connected in parallel. Output current is shared within 10% at full load. Derate to 90%. The current share function is not designed to offer redundant operation.

## Efficiency Versus Load

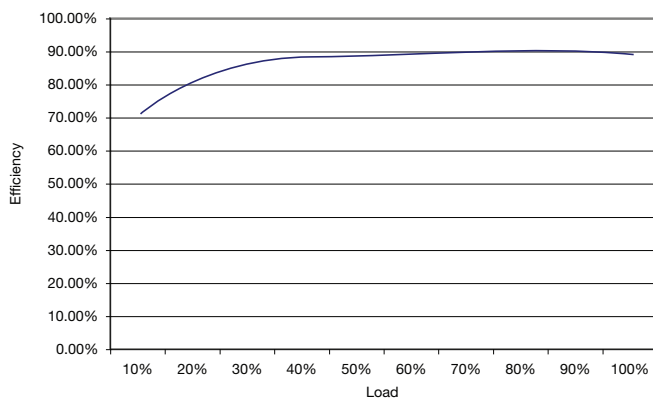

Figure 15  
EMA212PS12

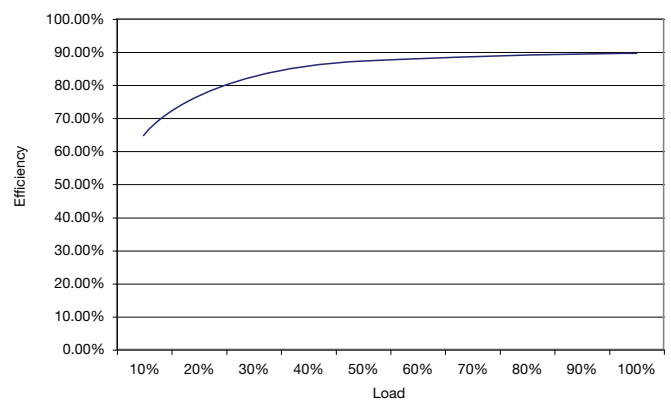

Figure 16  
EMA212PS48

## Combined Power Fail & DC OK Signal

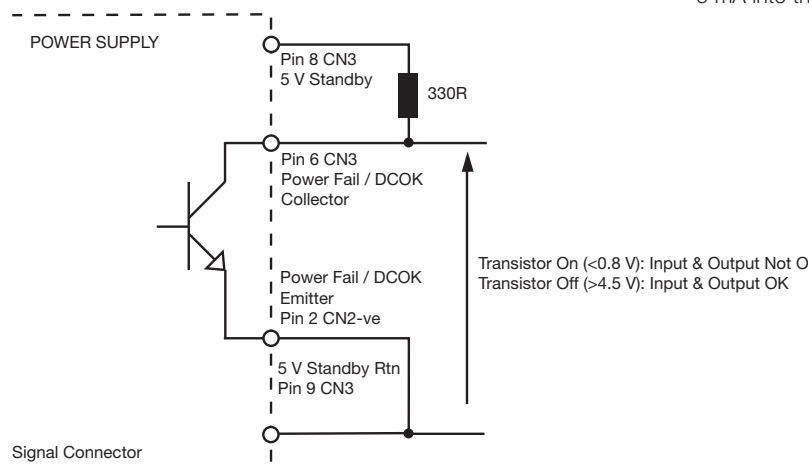
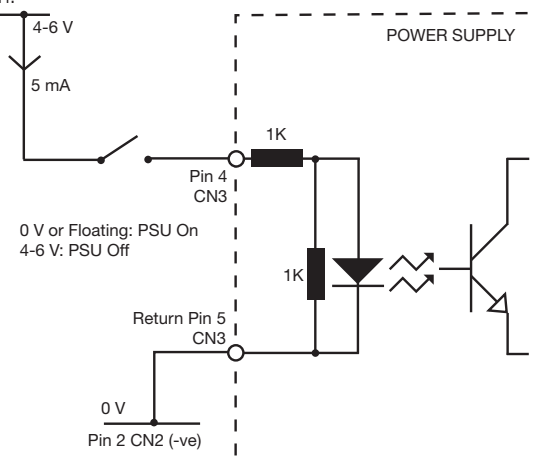

Figure 17

## Remote On/Off

Signal is an isolated control signal which can turn the PSU off by supplying 5 mA into the pin.



## Signals

KEY  
 ① AC  
 ② Comined Power Fail & DC OK Signal

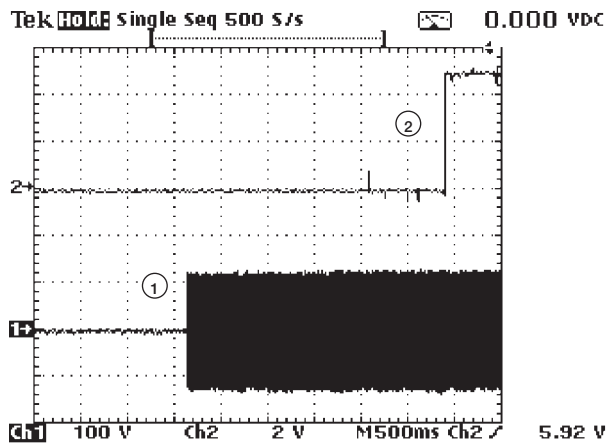

Figure 18  
 PF & DC OK signal 'V' AC switch on  
 90 VAC full load - 2.8 seconds

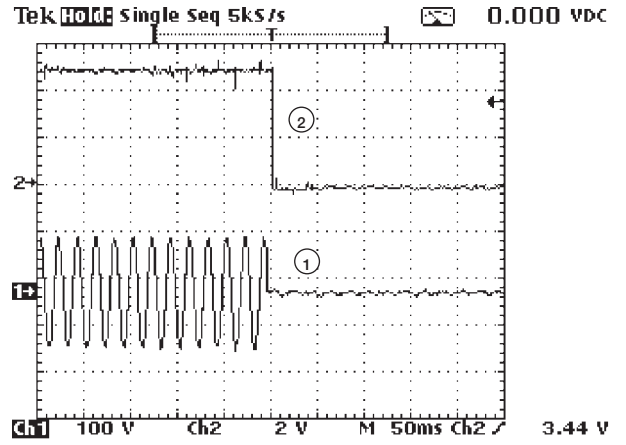

Figure 19  
 PF & DC OK signal 'V' AC switch off  
 90 VAC full load

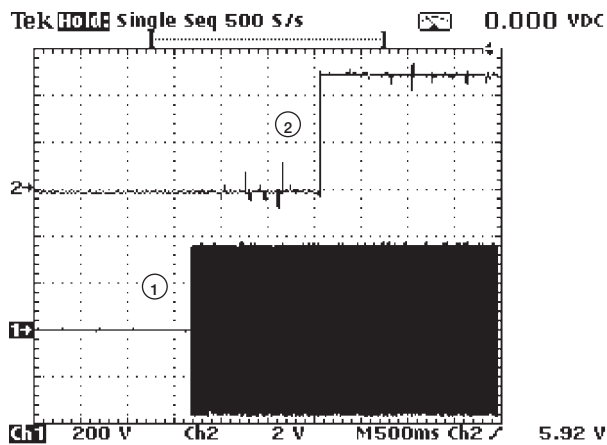

Figure 20  
 PF & DC OK signal 'V' AC switch on  
 264 VAC full load - 1.4 seconds

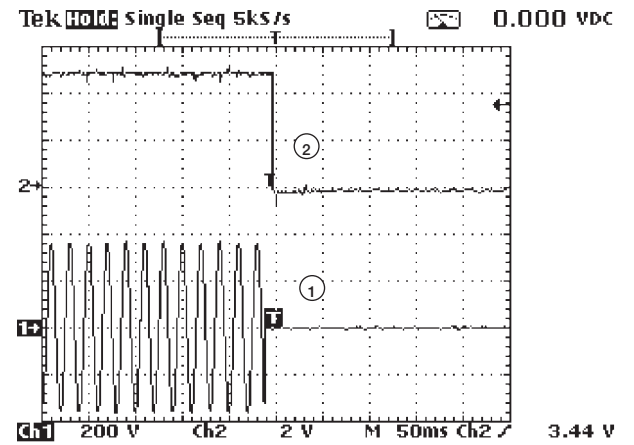

Figure 21  
 PF & DC OK signal 'V' AC switch off  
 264 VAC full load



## Signals

KEY			
① AC	② V1	③ V FAN V2	④ V STANDBY V3

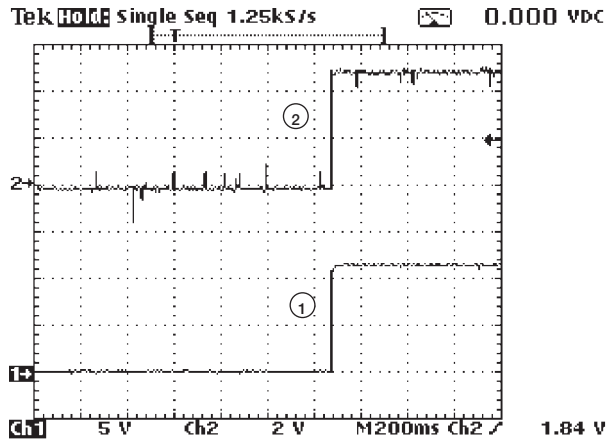

Figure 22  
PF/DC OK signal 'V' V1 switch on full load

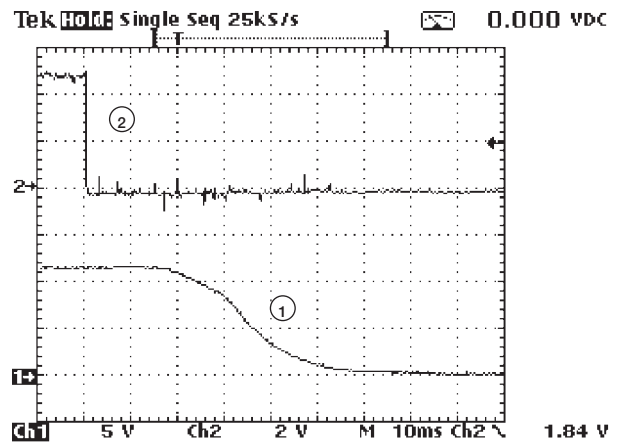

Figure 23  
PF/DC OK signal 'V' V1 switch off full load

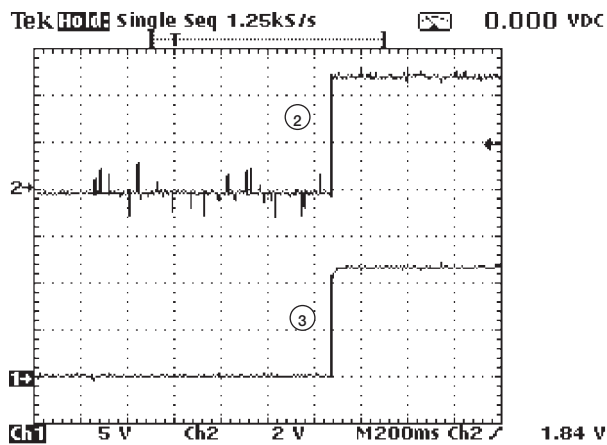

Figure 24  
PF/DC OK signal 'V' V2 switch on full load

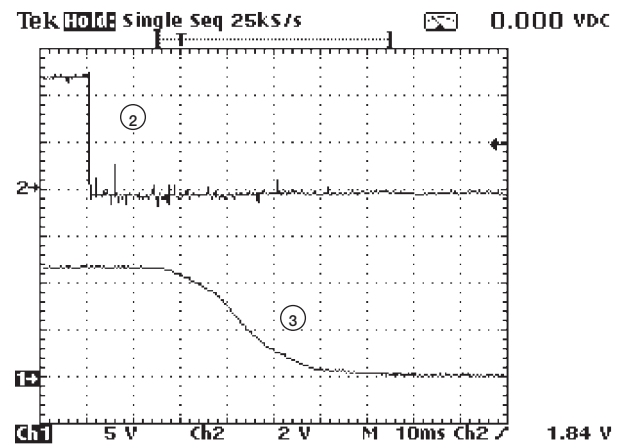

Figure 25  
PF/DC OK signal 'V' V2 switch off full load

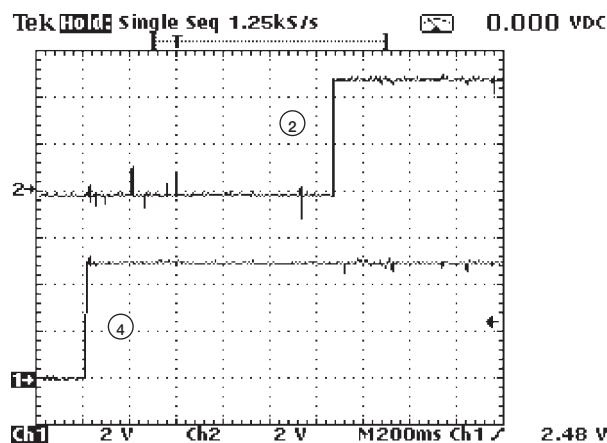

Figure 26  
PF/DC OK signal 'V' V3 switch on full load

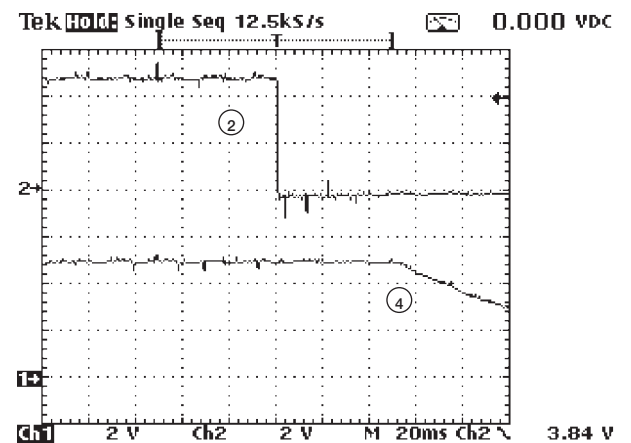

Figure 27  
PF/DC OK signal 'V' V3 switch off full load

## Environmental

Characteristic	Minimum	Typical	Maximum	Units	Notes & Conditions
Operating Temperature	-10		+70	°C	Derate linearly from +50 °C at 2.5%/°C to 50% at 70 °C
Storage Temperature	-20		+85	°C	
Cooling	12			CFM	See Thermal Considerations. No convection cooled rating
Humidity	5		95	%RH	Non-condensing
Operating Altitude			3000	m	
Shock			30	g peak	Half sine 6 axes
Vibration			2	g	5 Hz to 500 Hz, 3 axes

## Electromagnetic Compatibility - Immunity

Phenomenon	Standard	Test Level	Criteria	Notes & Conditions
Harmonic Current	EN61000-3-2		Class A	
EFT	EN61000-4-4	3	A	
Surge	EN61000-4-5	3	A	
Conducted	EN61000-4-6	10V rms	A	
Dips and Interruptions	EN61000-4-11	30% 10 ms	A	
		60% 100 ms	B	
		100% 5000 ms	B	

## Electromagnetic Compatibility - Emissions

Phenomenon	Standard	Test Level	Criteria	Notes & Conditions
Conducted	EN55022	Class B		See fig. 19
Radiated	EN55022	Class A		
Voltage Flicker	EN61000-3-3			

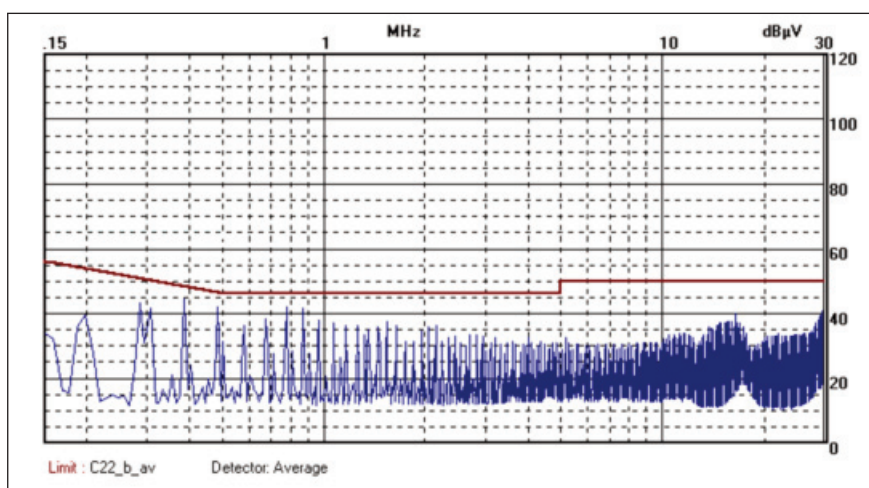
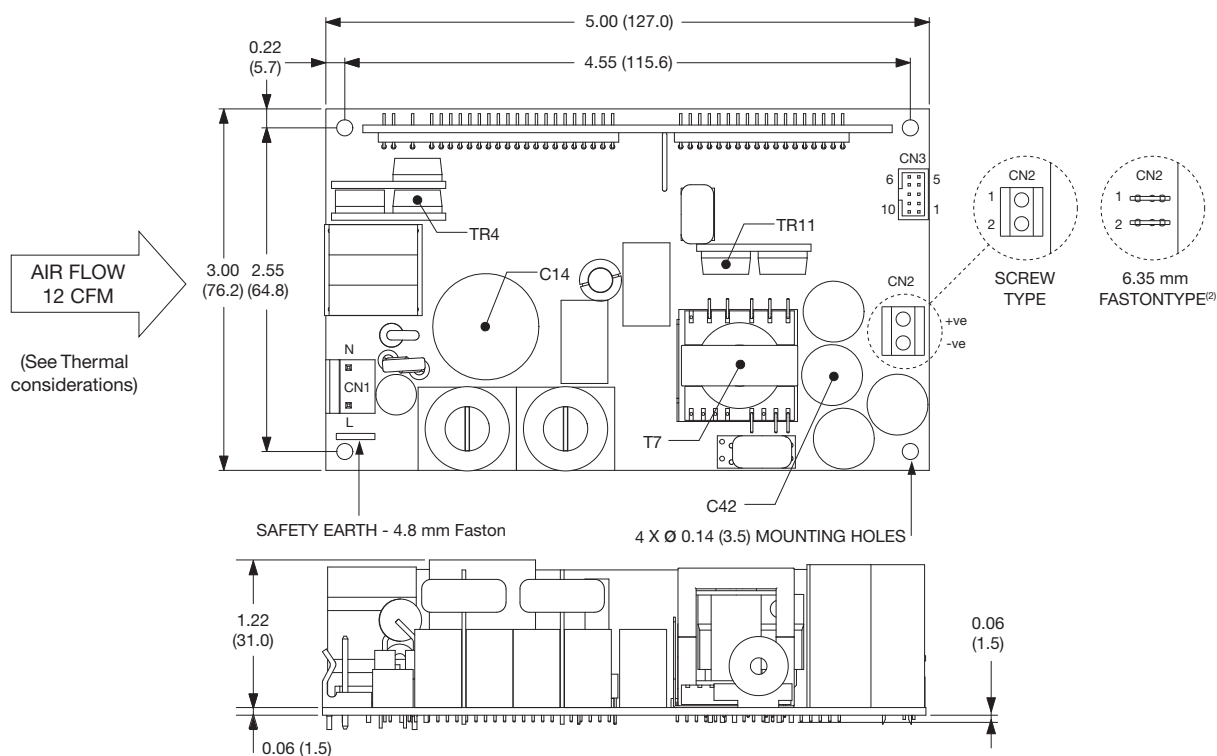

Figure 19  
Typical EMC plot

## Safety Agency Approvals

Safety Agency	Safety Standard	Category
CB Report	CSA 155548-1790828 IEC60950-1:2001	Information Technology
CSA	CSA CERTIFICATE # 17980822 CSA 22.2 No. 60950-1-03	Information Technology
UL	UL File # E139109 UL60950-1 (2003)	Information Technology
TUV	TUV Certificate # B 07 03 57396 026 EN60950-1/A11:2004	Information Technology
CE	LVD	

## Mechanical Details



### Notes

1. All dimensions in inches (mm).
2. Units supplied with screw terminal (CN2) as standard. For faston type, add suffix '-F' to the part number.
3. All 4 mounting positions should be connected to safety earth.
4. The air flow needs to be directed through the power supply within the end application.

## Pin Connections

PIN CONNECTIONS - CN2	
1	+V1
2	V1 Return

PIN CONNECTIONS - CN3	
1	+V2
2	V2 Return
3	V2 Return
4	ROF
5	ROF Return
6	Power Fail/DC OK
7	Current Share
8	+V3
9	-V3
10	+V2

**Mating Connectors:**  
 CN1: Molex housing 09-50-3031 and crimp 2878.  
 CN3: Molex housing 51110-1050 and crimp 50394-8100.

## Thermal Considerations

In order to ensure safe operation of the PSU in the end-use equipment, the temperature of the components listed in the table below must not be exceeded. Temperature should be monitored using K type thermocouples placed on the hottest part of the component (out of any direct air flow). See

Temperature Measurements (Ambient $\leq$ 50 $\text{°C}$ )	
Component	Max Temperature $\text{°C}$
TR4 case	110 $\text{°C}$
C14	105 $\text{°C}$
C42	105 $\text{°C}$
TR11 case	110 $\text{°C}$
T7 coil	120 $\text{°C}$

drawing on page 11 for component locations.

## Service Life

The estimated service life of the EMA212 is determined by the cooling arrangements and load conditions experienced in the end application. Due to the uncertain nature of the end application this estimated service life is based on the actual measured temperature of two key capacitors within the product when installed in the end application. The highest of the two component temperatures should be used.

The graph below expresses the estimated lifetime for a given component temperature and assumes continuous operation at this temperature.

## Estimated Service Life vs Component Temperature

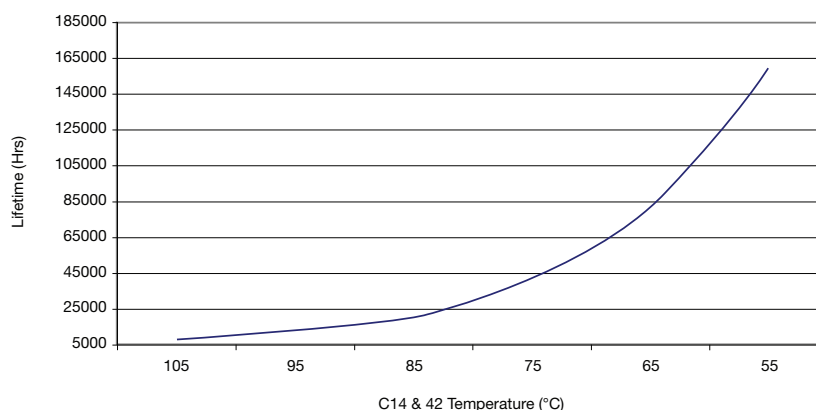

## **X-ON Electronics**

Largest Supplier of Electrical and Electronic Components

*Click to view similar products for [XP Power](#) manufacturer:*

Other Similar products are found below :

[FCM400PS12](#) [HDS1500PS12](#) [ECE40US24-SD](#) [ECE40US48](#) [EMH250PS12](#) [EML30US03-S](#) [IA0524D](#) [IR0512SA](#) [ISW0505A](#) [ITQ4824SA](#)  
[ITV2405SA](#) [JCA0248S05](#) [JCD0412D05](#) [JCK3012S05](#) [LCL300PS12](#) [IE1205SH](#) [IL4805S](#) [ISH1515A](#) [JCA0305S15](#) [JCE0624D05](#)  
[JCG1212S05](#) [JCK1524D12](#) [JTE0624D24](#) [VER05US060-JA](#) [JTL6048S12](#) [JTK3024S15](#) [JTC0648D03](#) [ACS40-60](#) [LOOM](#) [JCG1512D12](#)  
[RCQ50110S15](#) [JCD0612S05](#) [IF0503S](#) [IEU0224D12](#) [IEQ0524S3V3](#) [IEU0312D05](#) [IEQ0548S24](#) [VER18US150-JA](#) [VER18US120-JA](#)  
[AH20N-12](#) [TR05S15](#) [A20N-5](#) [A12N-5](#) [DTE2048S48](#) [DNR240TS24-I](#) [JCD0612D12](#) [IT4812SA](#) [IT4812S](#) [EML30US09-P](#) [EML15US12-S](#)  
[CA02P-5](#)