

### 30 Watts

- +24VDC Input [22 to 30V]
- Output Voltage & Current Regulated
- 0 to 100% Programmable Output & Current
- Voltage & Current Monitor Outputs
- Operating Temperature: -40°C to +70°C
- Short Circuit, Arc, and Overload Protections
- On-board +5V Reference
- Efficiency >80%
- Low Ripple <0.05%
- Premier Thermal Performance
- UL 60950 and 62368 Approved
- 3 Year Warranty



#### Dimensions:

##### HRL30:

3.0 x 1.5 x 0.73" (76.2 x 38.1 x 18.6 mm)

#### Key Applications:

- Mass Spectrometry
- Electrophoresis
- E-beam/Ion Beam
- Electrostatic Chuck
- Capacitor Charging
- Photo Multiplier Tube
- Scanning Electron Microscopy

The HRL30 series, is a miniature 30W regulated high voltage DC-DC converter product line providing voltages up to 6kV. HRL30 offers both voltage and current mode controls and monitors. This product deploys a proprietary design which delivers accurate high voltage at higher efficiency with low EMI. This product has constant voltage and constant current operation with automatic crossover to current limiting mode preventing the delivered current from exceeding the programmed current level. It has digital compatible voltage and current monitors and controls to make it a convenient product for a wide range of high voltage applications.

### Models & Ratings

Output voltage	Output current	Input current		Ripple & Noise	Model number
		No load <sup>(1)</sup>	Full load		
0 to +200V	150mA	50mA	1.5A	≤0.05%	HRL3024S200P
0 to -200V	150mA	50mA	1.5A	≤0.05%	HRL3024S200N
0 to +350V	85.7mA	50mA	1.5A	≤0.05%	HRL3024S350P
0 to -350V	85.7mA	50mA	1.5A	≤0.05%	HRL3024S350N
0 to +600V	50.0mA	50mA	1.5A	≤0.01%	HRL3024S600P
0 to -600V	50.0mA	50mA	1.5A	≤0.01%	HRL3024S600N
0 to +1000V	30.0mA	50mA	1.5A	≤0.04%	HRL3024S1K0P
0 to -1000V	30.0mA	50mA	1.5A	≤0.04%	HRL3024S1K0N
0 to +1500V	20.0mA	50mA	1.5A	≤0.05%	HRL3024S1K5P
0 to -1500V	20.0mA	50mA	1.5A	≤0.05%	HRL3024S1K5N
0 to +2000V	15.0mA	50mA	1.5A	≤0.05%	HRL3024S2K0P
0 to -2000V	15.0mA	50mA	1.5A	≤0.05%	HRL3024S2K0N
0 to +2500V	12.0mA	100mA	1.5A	≤0.05%	HRL3024S2K5P
0 to -2500V	12.0mA	100mA	1.5A	≤0.05%	HRL3024S2K5N
0 to +3000V	10.0mA	100mA	1.5A	≤0.05%	HRL3024S3K0P
0 to -3000V	10.0mA	100mA	1.5A	≤0.05%	HRL3024S3K0N
0 to +4000V	7.5mA	100mA	1.5A	≤0.05%	HRL3024S4K0P
0 to -4000V	7.5mA	100mA	1.5A	≤0.05%	HRL3024S4K0N
0 to +5000V	6.0mA	100mA	1.5A	≤0.04%	HRL3024S5K0P
0 to -5000V	6.0mA	100mA	1.5A	≤0.04%	HRL3024S5K0N
0 to +6000V	5.0mA	100mA	1.5A	≤0.04%	HRL3024S6K0P
0 to -6000V	5.0mA	100mA	1.5A	≤0.04%	HRL3024S6K0N

#### Notes

1. Typical at 24V input
2. Specifications after 30-minute warm up, at full load, maximum output voltage and 25°C, unless otherwise indicated.

3. No current derating over temperature range.
4. Proper thermal management techniques are required to maintain safe case temperature at maximum power output.

### Input

Characteristic	Minimum	Typical	Maximum	Units	Notes & Conditions
Input Voltage Range	22	24	30	VDC	24 V nominal
Input Current			1.55	A	See Models and Ratings Table
Input Filter	Internal Pi filter				
Input Undervoltage Lockout	OFF/Shutdown @ <20.5V, ON/Restart @ >21.5V				
Input Overvoltage Protection	OFF/Shutdown @ >31.5V, ON/Restart @ <30.5V				
Programming Inputs	0		5	VDC	Analog DC Voltage Controls Output 0 to 100%, See Signals.
Overprogramming Protection		5.5		VDC	110% Max Voltage & Current

### Output

Characteristic	Minimum	Typical	Maximum	Units	Notes & Conditions
Output Voltage			6000	VDC	See Models and Ratings Table
Output Current			150	mA	See Models and Ratings Table
Output Programming	0		100	%	Output Voltage/Current programmable via Analog DC Programmig Voltage Input
Output Calibration Range		±5		%	Potentiometer, See Signals & Controls
Initial Setpoint Accuracy		±1		%	@ Max Vp gm, No Load
Linearity: Output vs Program			1.5	%	10 to 100% Output
Minimum Load	No minimum load required				
Start Up Response	See Applications Notes, page 5				
Line Regulation			0.01	%	100% Vp gm, Full Load, [Min to Max Input]
Load Regulation			0.01	%	100% Vp gm, 24Vin, [NL to FL]
Transient Response	5% typical				
Ripple and Noise	0.01		0.05	%	1MHz bandwidth, See Models and Ratings Table
Temperature Coefficient		100		ppm/°C	
Stability			100	ppm/8hrs	After 30 minute warm up
Short Circuit, Overload					Rectanguar V/I characteristics.
Overtemp Protection		95		°C	Shutdown @ 95°C typical, +/-5% at the hot spot

### General

Characteristic	Minimum	Typical	Maximum	Units	Notes & Conditions
Efficiency	80	85		%	Max Vp gm, Full Load
Isolation: Input to Output	N/A – Input ground is internally connected to output ground				
Isolated Baseplate			1500	VDC	
Construction	DAP case. Solid vacuum encapsulation, UL 94 V-0 rated.				
Switching Frequency		100		kHz	
Mean Time Between Failure	1			MHrs	MIL-HDBK-217F, +25 °C GB
Weight		0.26 (120 g)		lb (g)	

### Environmental

Characteristic	Minimum	Typical	Maximum	Units	Notes & Conditions
Operating (Base Plate) Temperature	-40		+70	°C	Consult factory for extended operating temperature
Storage Temperature	-55		+105	°C	
Humidity			95	%RH	Non-condensing
Cooling					Natural convection

### Safety Approvals

Safety Agency	Safety Standard	Notes & Conditions
UL	IEC/UL/CSA/EN 62368, 60950	
CE	CE Directive, RoHs and LVD	Where applicable
RoHS	RoHS 2 and 3 Directive (2011/65/EU)	Where applicable

### Signals

Characteristic	Pin	Function	Description
-VIN	1	Input Ground	Input Power Ground
DISABLE	2	Input: Remote Disable	Open or No Connect turns unit ON. Ground connection turns unit OFF
VREF	3	Output: Voltage Reference	+5V +/-2% - current <10mA
SGND	4	Signal Ground	Signal Ground
VPGM	5	Input: Voltage Programming	0V to +5V signal programs Vout from 0 to 100%, Z=100kohm.
VMON	6	Output: Voltage Monitor	0V to +5V output measures 0 to 100% Vout, 1.5% accuracy.
IPGM	7	Input: Current Programming	0V to +5V signal programs Iout from 0 to 100%, Z=100kohm.
IMON	8	Output: Current Monitor	0V to +5V output measures 0 to 100% Iout, 1.5% accuracy.
N/C	9	N/A	
N/C	10	N/A	
N/C	11	N/A	
+VIN	12	Input: 24Vin	Power Input
HVOUT	13	HV Output	High Voltage Output
HVRTN	14	HV Return	High Voltage Return

### Mechanical Details

#### Standard

TOP VIEW

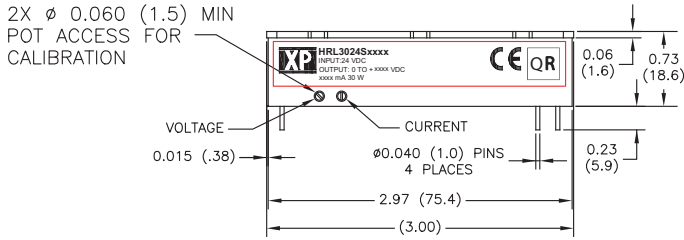
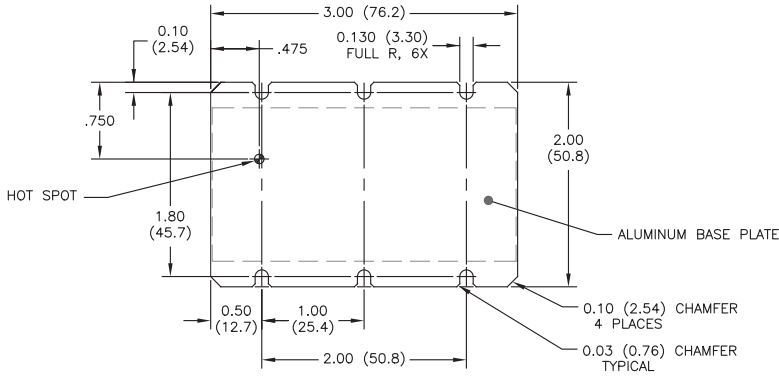

RECOMMENDED PCB LAYOUT TOP VIEW

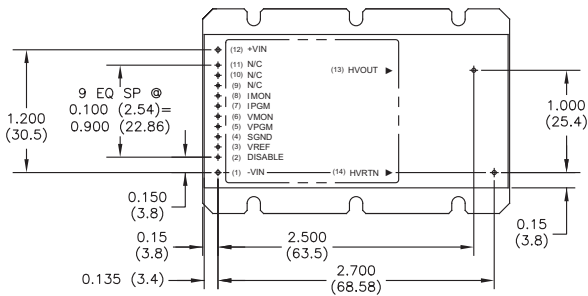
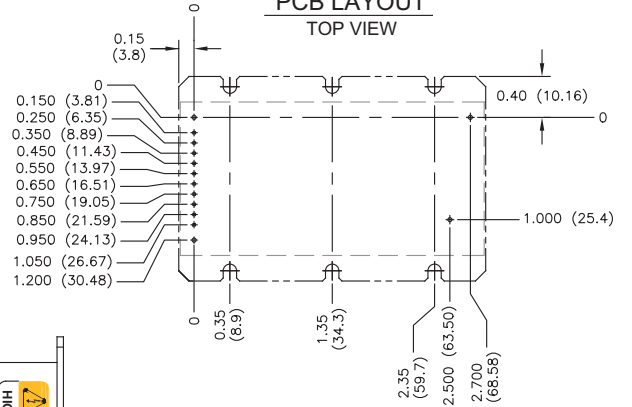

BOTTOM VIEW

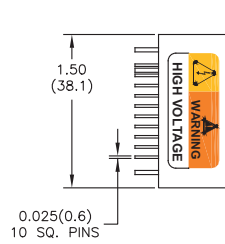

#### Notes

1. All dimensions are in inches (mm)
2. Weight: 0.26 lbs (120 g) approx

3. Tolerance: X.XX±0.02 (0.51)
4. Pin Tolerance: ±0.005 (0.127)

### Mechanical Details

#### Optional

TOP VIEW

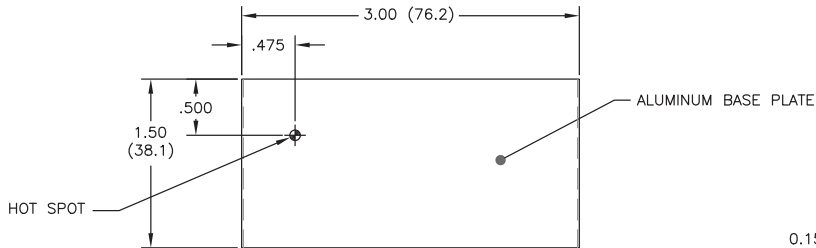

RECOMMENDED  
PCB LAYOUT  
TOP VIEW

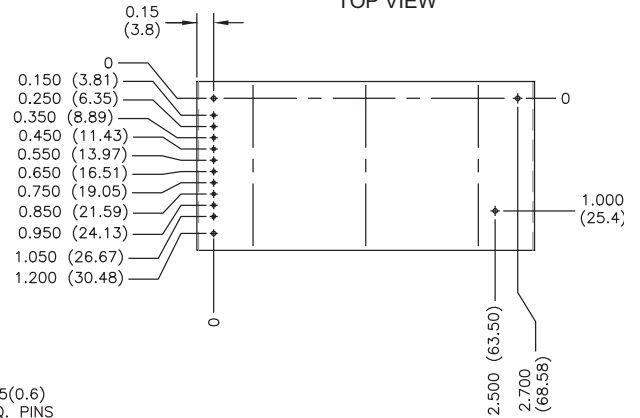

2X  $\phi$  0.060 (1.5) MIN  
POT ACCESS FOR  
CALIBRATION

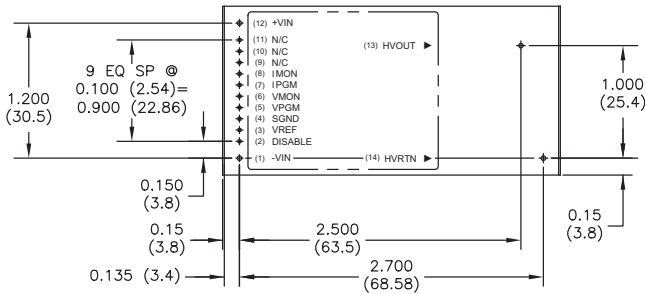
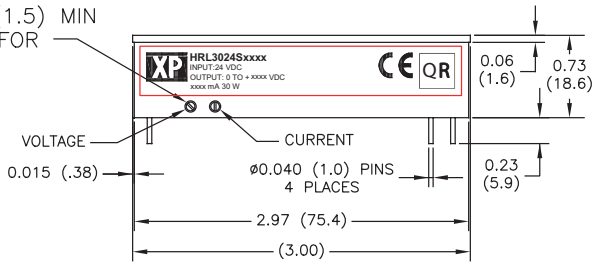

BOTTOM VIEW

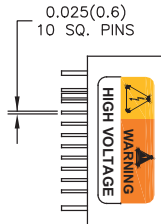

#### Notes

1. All dimensions are in inches (mm)
2. Weight: 0.26 lbs (120 g) approx

3. Tolerance: X.XX $\pm$ 0.02 (0.51)
4. Pin Tolerance:  $\pm$ 0.005 (0.127)

### Application Notes

#### Vref programming

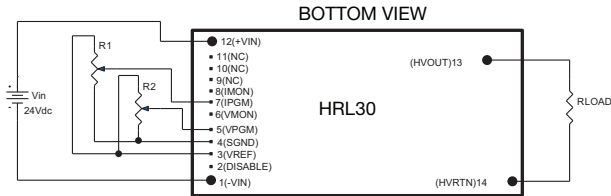

#### Startup rise time Vout vs Vpgm

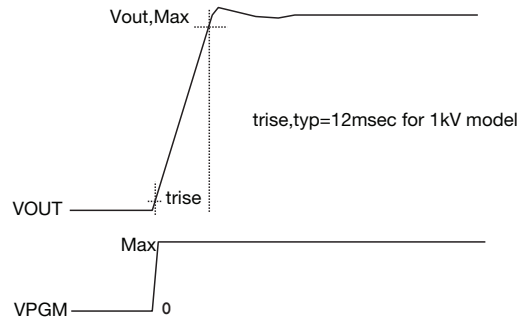

#### V/I rectangular characteristics

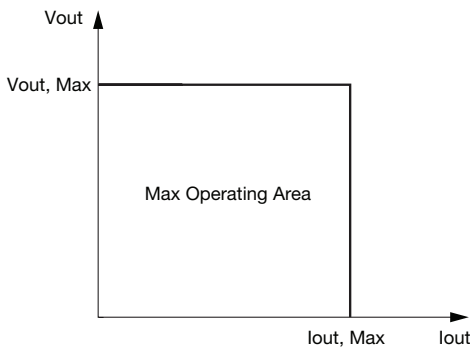

#### V/I programming linearity

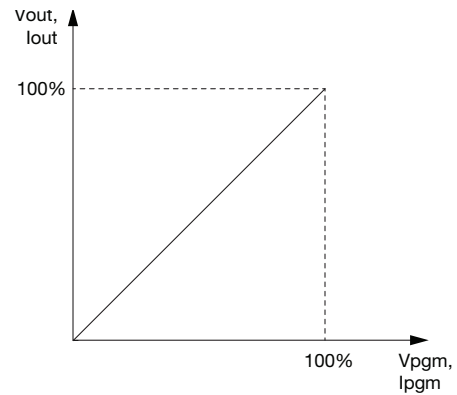

## X-ON Electronics

Largest Supplier of Electrical and Electronic Components

*Click to view similar products for [Isolated DC/DC Converters](#) category:*

*Click to view products by [XP Power](#) manufacturer:*

Other Similar products are found below :

[ESM6D044440C05AAQ](#) [FMD15.24G](#) [PSL486-7LR](#) [Q48T30020-NBB0](#) [18362](#) [JAHW100Y1](#) [SPB05C-12](#) [SQ24S15033-PS0S](#) [19-130041](#)  
[CE-1003](#) [RDS180245](#) [MAU228](#) [J80-0041NL](#) [DFC15U48D15](#) [XGS-0512](#) [XGS-1205](#) [XGS-1212](#) [XGS-2412](#) [XGS-2415](#) [XKS-1215](#) [06322](#)  
[NCT1000N040R050B](#) [SPB05B-15](#) [SPB05C-15](#) [L-DA20](#) [DCG40-5G](#) [QME48T40033-PGB0](#) [XKS-2415](#) [XKS-2412](#) [XKS-1212](#) [XKS-1205](#)  
[XKS-0515](#) [XGS-2405](#) [XGS-1215](#) [XGS-0515](#) [73-551-5038I](#) [AK1601-9RT](#) [VI-R5022-EXWW](#) [PSC128-7iR](#) [RPS8-350ATX-XE](#)  
[DAS1004812](#) [PQA30-D24-S24-DH](#) [VI-M5F-CQ](#) [VI-LN2-EW](#) [VI-PJW01-CZY](#) [CK2540-9ERT](#) [AK-1615-7R](#) [700DNC40-CON-KIT-8G](#)  
[350DNC40-CON-KIT-9G](#) [088-101348-G](#)