

1W

DC-DC CONVERTER

The single output IEB01 series is an ideal solution for isolating voltage rails in a distributed power supply architecture such as analog, digital, data and relay circuits. This product family offers a compact, long-lasting design with high efficiency, 1.5kV functional isolation, short circuit protection and high operating temperature.



Features

- Unregulated single output
- $\pm 10\%$ input range
- Single outputs 3.3 to 24VDC
- SIP4 package
- 1.5 kVDC functional isolation
- Continuous short circuit protection
- Class B conducted & radiated emissions
- -40°C to $+105^{\circ}\text{C}$ operating temperature
- Full load to $+85^{\circ}\text{C}$ ambient
- 3 year warranty

Applications

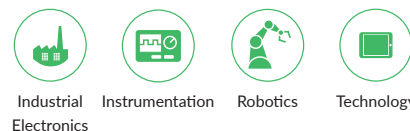

Dimensions

0.46" x 0.40" x 0.24" (11.6 x 10.16 x 6.0mm)

General

Characteristic	Minimum	Typical	Maximum	Units	Notes & Conditions
Efficiency		80		%	See models & ratings table
Isolation: Input to Output	1500			VDC	Functional isolation. 60s test, evaluated to 3kVDC for 1s
Isolation Resistance	10^9			Ω	
Isolation Capacitance		20		pF	
Switching Frequency		260/270		kHz	100% load and nominal input. Others / IEB0105
Power Density			22	W/in ³	
Mean Time Between Failure	3.5			Mhrs	MIL-HDBK-217F, +25°C GB
Weight		0.0028 (1.3)		lb (g)	
Case Material	Black plastic, flame retardant UL94V-0				
Pin Material	Phosphor bronze, solder coated				
Solder Profile			300	$^{\circ}\text{C}$	1.5mm from case 10s max
Water Wash	Use deionized water. Dry thoroughly				

Models & Ratings

Model Number	Input Voltage	Output Voltage	Output Current	Maximum Capacitive Load	Efficiency at Vin Nominal with Full Load ⁽¹⁾
IEB0105S3V3	5V (4.5-5.5V)	3.3V	303mA	2400µF	74%
IEB0105S05		5V	200mA	2400µF	82%
IEB0105S09		9V	111mA	1000µF	83%
IEB0105S12		12V	84mA	560µF	83%
IEB0105S15		15V	67mA	560µF	83%
IEB0105S24		24V	42mA	220µF	85%
IEB0112S3V3	12V (10.8-13.2V)	3.3V	303mA	2400µF	75%
IEB0112S05		5V	200mA	2400µF	80%
IEB0112S09		9V	111mA	1000µF	80%
IEB0112S12		12V	83mA	560µF	80%
IEB0112S15		15V	67mA	560µF	81%
IEB0112S24		24V	42mA	220µF	81%
IEB0115S05	15V (13.5-16.5V)	5V	200mA	2400µF	80%
IEB0115S09		9V	111mA	1000µF	80%
IEB0115S12		12V	83mA	560µF	80%
IEB0115S15		15V	67mA	560µF	81%
IEB0115S24		24V	42mA	220µF	81%
IEB0124S3V3		24V (21.6-26.4V)	3.3V	303mA	2400µF
IEB0124S05	5V		200mA	2400µF	79%
IEB0124S09	9V		111mA	1000µF	80%
IEB0124S12	12V		83mA	560µF	81%
IEB0124S15	15V		67mA	560µF	81%
IEB0124S24	24V		42mA	220µF	81%

Notes:

1. Measured at nominal input voltage and full load.

2. Pack size 43pcs per tube

Input

Characteristic	Minimum	Typical	Maximum	Units	Notes & Conditions
Input Voltage Range	4.5		5.5	VDC	5V nominal
	10.8		13.2		12V nominal
	13.5		16.5		15V nominal
	21.6		26.4		24V nominal
Input Filter	Capacitor				
Input Reflected Ripple		15		mA pk-pk	Measured through 4.7µH inductor and 220µF capacitor
Input Surge	-0.7		9	VDC	5V models, 1s
	-0.7		18		12V models, 1s
	-0.7		21		15V models, 1s
	-0.7		30		24V models, 1s

Output

Characteristic	Minimum	Typical	Maximum	Units	Notes & Conditions
Output Voltage	3.3		24	VDC	See Models & Ratings table
Initial Set Accuracy				%	See regulation curves
Minimum Load	10			%	Minimum load required to meet specification. Operation at no load will not cause damage.
Line Regulation			±1.2	%	Per 1% change of input voltage
			±1.5		3.3V output models, per 1% change of input voltage
Load Regulation				%	From 10% to full load. See regulation curves
Ripple & Noise			75	mV pk-pk	Measured using parallel cable, 20MHz bandwidth and 10µF ceramic capacitor
			100		24V output models, measured using parallel cable, 20MHz bandwidth and 10µF ceramic capacitor
Short Circuit Protection	Continuous, with autorecovery				
Maximum Capacitive Load	See Models & Ratings table				
Temperature Coefficient			±0.02	%/ °C	100% load

Environmental

Characteristic	Minimum	Typical	Maximum	Units	Notes & Conditions
Operating Temperature	-40		+105	°C	Derate from 100% load at +85°C to 80% load at +105°C
Storage Temperature	-55		+125	°C	
Case Temperature			105	°C	
Humidity			95	%RH	Non-condensing
Cooling	Natural convection				

Safety Approvals

Safety Agency	Standard	Notes & Conditions
UL	UL/cUL62368-1	ITE
CE	Meets all applicable directives	
UKCA	Meets all applicable legislation	

EMC: Emissions

Phenomenon	Standard	Test Level	Notes & Conditions
Conducted	EN55032	Class B	See application notes
Radiated	EN55032	Class B	See application notes

EMC: Immunity

Phenomenon	Standard	Test Level	Criteria	Notes & Conditions
ESD Immunity	EN61000-4-2	3	B	Air ±8kV, Contact ±6kV, for IEB0105 Contact is ±4kV, level 2
Radiated Immunity	EN61000-4-3	3	A	10V/m

Application Notes

EMC (Class B) Compliance Circuit

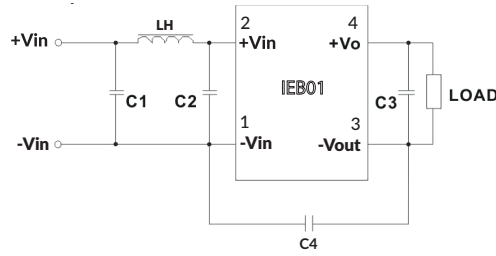

Model Number	Dual Vout (V)	C1	C2	C3	C4	LH
IEB0105	3.3	4.7μF/25V	4.7μF/25V	10μF/16V	Not fitted	6.8μH
	5			10μF/16V		
	9			2.2μF/25V	1nF/4kVDC	
	12			2.2μF/25V		
	15			1μF/50V		
	24			1μF/50V		
IEB0112, 15, 24	3.3	4.7μF/50V	4.7μF/50V	10μF/16V	270pF/2kVDC	6.8μH
	5			10μF/16V		
	9			2.2μF/16V		
	12			2.2μF/25V		
	15			1μF/25V		
	24			1μF/50V		

Typical Performance Curves

Fig 1. 3.3VDC Output

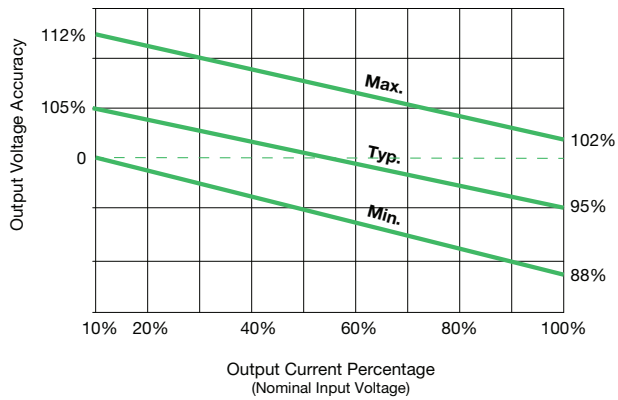

Fig 2. 5/9/12/15/24VDC Output applies to IEB0105

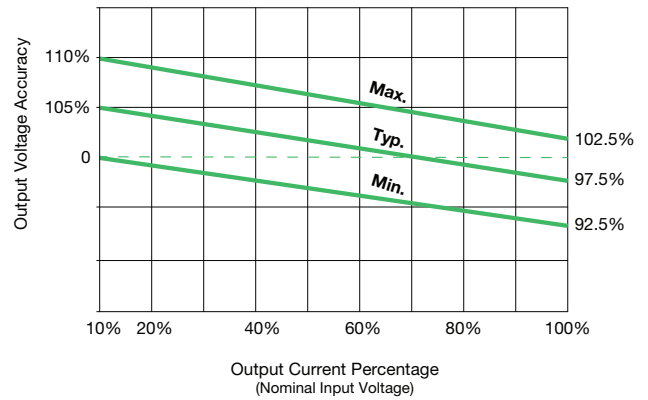

Fig 3. 5/9/12/15/24VDC Output

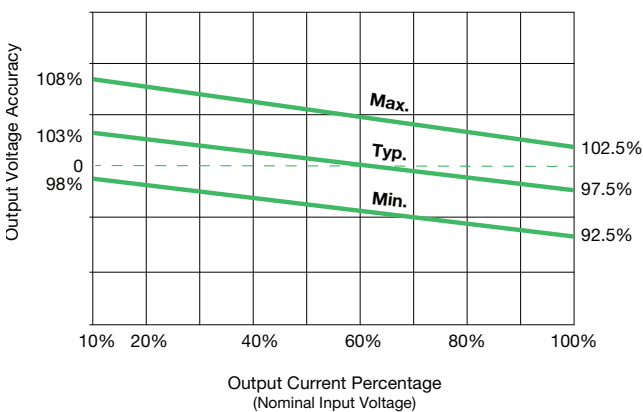
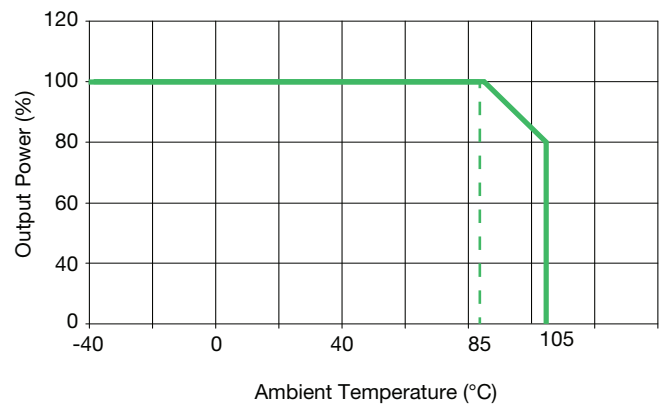
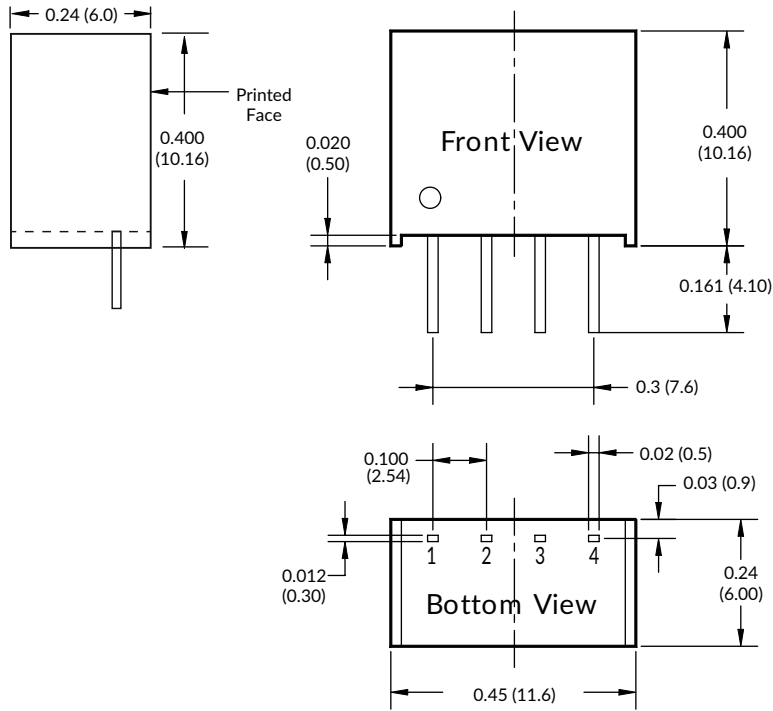

Fig 4. Temperature Derating Curve



Mechanical Details



Pin Connections	
Pin	Function
1	-Vin
2	+Vin
3	-Vout
4	+Vout

Notes:

1. All dimensions are in inches (mm)
2. Weight: 0.0028lbs (1.3g) approx.
3. Pin diameter: 0.039" (1.0mm)
4. Pin tolerance: $\pm 0.004"$ ($\pm 0.1\text{mm}$)
5. Case tolerance: $\pm 0.01"$ ($\pm 0.25\text{mm}$)

X-ON Electronics

Largest Supplier of Electrical and Electronic Components

Click to view similar products for [Isolated DC/DC Converters - Through Hole category](#):

Click to view products by [XP Power manufacturer](#):

Other Similar products are found below :

[PDME2-S5-S7-S](#) [PDME2-S5-S3-S](#) [PDME2-S5-D3-S](#) [PEME2-S5-D9-S](#) [PQC10-48-S5-O](#) [PQC10-48-S15-O](#) [PQC60-24-S5](#) [PQC60-24-S12](#)
[PQC60-24-S15-H](#) [PQC60-24-S12-H](#) [PQQ6W-Q24-D12-S](#) [PVQ100W-O72-S12-D](#) [PVQ100W-O72-S24-D](#) [PH1200A280-28/T](#) [PH1200A280-48/T](#) [PH1200A280-28](#) [PH1200A280-36](#) [PH1200A280-24/T](#) [PYD20-72WS12](#) [PYD20-72WS15](#) [PYD20-72WS05](#) [PYD20-72WD12](#) [PYD20-72WD24](#) [PYD20-72WD15](#) [PYH200-72WS48](#) [TEL 15-2411WIN](#) [TEL 15-4812WIN](#) [TEP 150-7211UIR](#) [THL 30-2410WI](#) [THL 30-2415WI](#)
[THL 30-2412WI](#) [THL 30-4812WI](#) [THL 30-2411WI](#) [TMR 12-2423WI](#) [TRV 2-1211M](#) [TRV 2-1210M](#) [TRV 2-2422M](#) [IAB0112D24](#)
[IAB0124D12](#) [IAB0105D24](#) [IAB0115D15](#) [IAB0105D05](#) [IAB0112D3V3](#) [IAB0124D05](#) [IAB0105D09](#) [IAB0115D12](#) [IAB0115D05](#)
[IAB0124D15](#) [IEB0112S12](#) [IEB0124S12](#)