

1 Watt

- Single unregulated output
- $\pm 10\%$ input range
- SMD DIP package
- 1.5kVDC isolation
- Industry standard pinout
- UL62368-1 safety approvals
- Continuous short circuit protection
- Tape & reel package available
- Operating temperature -40°C to $+105^{\circ}\text{C}$
- Full power to 100°C
- 3 year warranty

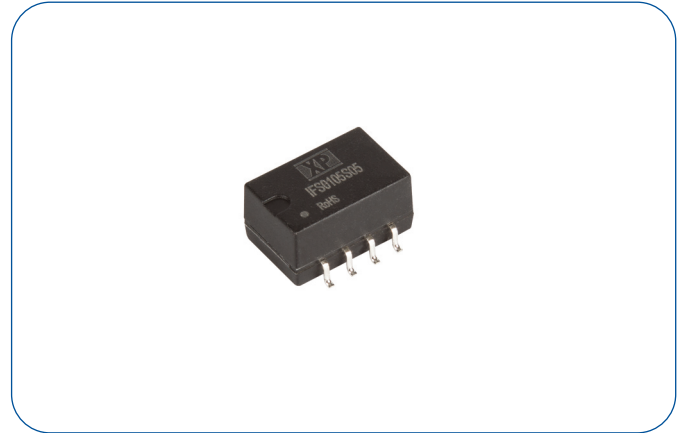

Dimensions:

IFS01 Single Output:
0.52 x 0.335 x 0.285" (13.2 x 8.5 x 7.25 mm)

The IFS01 series is an ideal solution for isolating voltage rails in a distributed power supply architecture such as analog, digital, data and relay circuits. This product family offers a compact design with high efficiency, 1.5kV isolation, short circuit protection and high operating temperature.

Models & Ratings

Input Voltage	Output Voltage	Output Current		Input Current ⁽¹⁾		Maximum Capacitive Load	Efficiency ⁽²⁾	Model Number ⁽⁴⁾
		Minimum	Maximum	No Load	Full Load			
5V (4.5-5.5 V)	5V	20mA	200mA	5mA	270mA	2400 μF	82%	IFS0105S05
	9V	12mA	111mA	12mA	241mA	1000 μF	83%	IFS0105S09
	12V	9mA	84mA	12mA	241mA	560 μF	83%	IFS0105S12

Notes

1. Typical input currents measured at nominal input voltage.
2. Typical value at full load.

3. Standard tube quantity = 38
4. For tape & reel option add suffix -TR. Reel quantity = 500

Mechanical Details

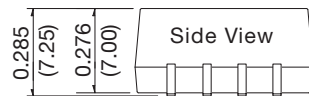
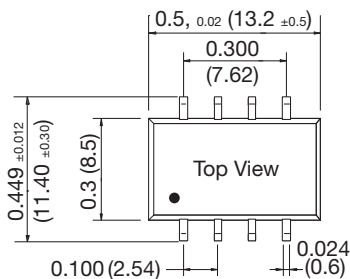

Recommended Footprint
Top View grid: 0.1 x 0.1 in (2.54 x 2.54 mm)

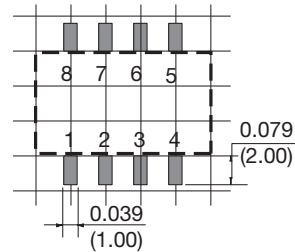

Pin Out	
Pin	Function
1	GND
2	Vin
4	0V
5	+Vo
3,6,7,8	NC

Notes

1. All dimensions are in inches (mm).
2. Weight: single output: 0.0028lbs (1.3g) typical

3. Pin pitch and length tolerance: ± 0.01 (± 0.25).
4. Case tolerance: ± 0.02 (± 0.5).

Input

Characteristic	Minimum	Typical	Maximum	Units	Notes & Conditions
Input Voltage Range	4.50		5.50	VDC	5V nominal
Input Current					See Models and Ratings table
Input Reflected Ripple		15		mA pk-pk	Through 4.7µH inductor and 220µF capacitor
Input Surge			9	VDC for 1 s	
Input Filter	Capacitor				

Output

Characteristic	Minimum	Typical	Maximum	Units	Notes & Conditions
Output Voltage	5		12	VDC	See Models and Ratings table
Initial Set Accuracy				%	See Load Regulation Curves
Minimum Load	10			%	
Line Regulation			±1.2	%	Per 1% change of input voltage (±1.5% for 3V3 output)
Load Regulation				%	See load regulation curves
Ripple and Noise		30	75	mV pk-pk	20MHz bandwidth, measured using 0.1µF capacitor
Short Circuit Protection	Continuous, with auto recovery				
Maximum Capacitive Load				µF	See Models and Ratings table
Temperature Coefficient			±0.02	%/°C	

General

Characteristic	Minimum	Typical	Maximum	Units	Notes & Conditions
Efficiency					See Models and Ratings table
Isolation: Input to Output	1500			VDC	Functional
Switching Frequency	270		278	kHz	Low input voltage 10% load to high input voltage at full load
Isolation Resistance	10 ⁹			Ω	Input to output, tested at 500VDC
Isolation Capacitance		20		pF	Input to output
Power Density		20		Win ³	
Mean Time Between Failure	3500			kHrs	MIL-HDBK-217F, +25°C GB
Weight		0.002 (1.3)		lb (g)	Single output
Moisture Sensitivity Level (MSL)	Level 1				
Case Material	Black plastic, flame retardant UL94 V-0				
Pin Material	Phosphor bronze, solder coated				
Recommended Solder Profile	IPC/JEDEC J-STD-020D.1			Peak temp ≤245°C, max duration, ≤60s at 217°C	
Water Washing	Non-soaking water wash with de-ionised water. Dry thoroughly.				

Environmental

Characteristic	Minimum	Typical	Maximum	Units	Notes & Conditions
Operating Temperature	-40		+105	°C	Derate from 100% load at +100°C to 80% load at 105°C
Storage Temperature	-55		+125	°C	
Case Temperature			+105	°C	
Case Temperature Rise		15		°C	Ambient 25°C
Operating Humidity			95	% RH	Non-condensing
Cooling	Natural convection				

Safety Approvals

Safety Agency	Safety Standard	Notes & Conditions
UL	UL62368-1	
CE	Meets all applicable directives	
UKCA	Meets all applicable legislation	

EMC: Emissions

Phenomenon	Standard	Test Level	Notes & Conditions
Conducted	EN55032	Class B	See Application Note for Class B filter
Radiated	EN55032	Class B	See Application Note for Class B filter

EMC: Immunity

Phenomenon	Standard	Test Level	Criteria	Notes & Conditions
ESD Immunity	EN61000-4-2	Air $\pm 8\text{kV}$, Contact $\pm 4\text{kV}$	B	

Load Regulation

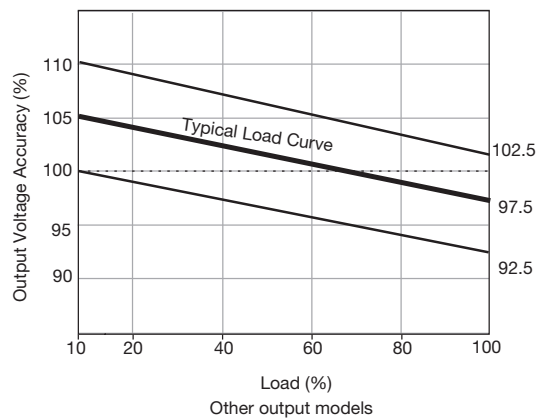

Application Note

EMI Filter for Class B Emissions

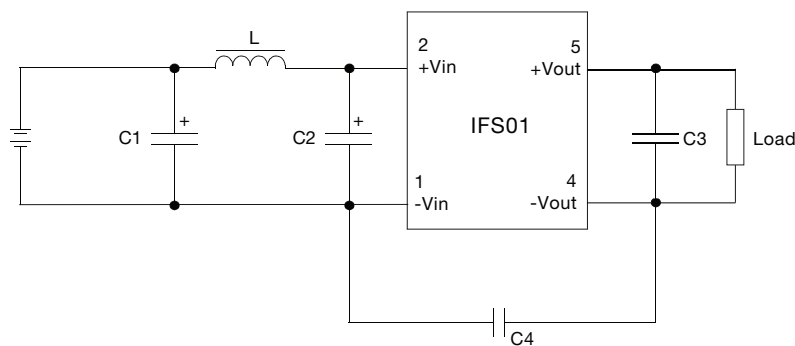

Component	Output Voltage			Notes
	5V	9V	12V	
C1, C2	4.7 μF	4.7 μF	4.7 μF	25V rated
C3	10 μF	4.7 μF	2.2 μF	25V rated
C4	Not Fitted			2kV rated, ML Ceramic
L	6.8 μH	6.8 μH	6.8 μH	

Application Note

Temperature Derating Curve

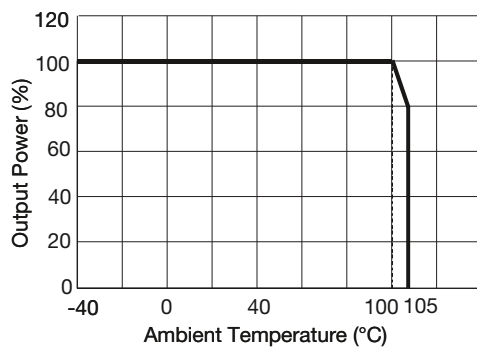

Efficiency vs Input Voltage (example IFS0105S05)

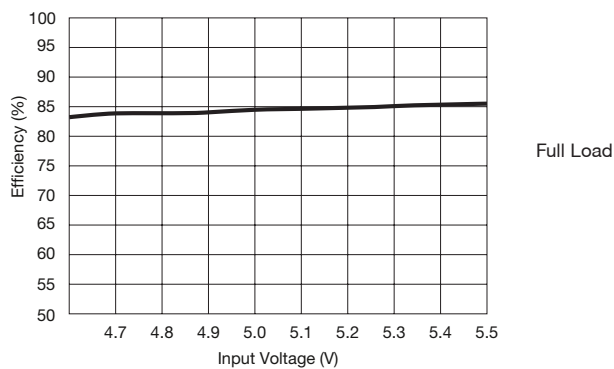

Efficiency vs Output Load (example IFS0105S05)

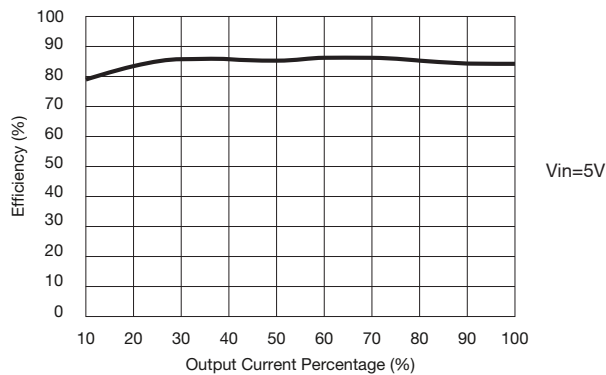

X-ON Electronics

Largest Supplier of Electrical and Electronic Components

Click to view similar products for [Isolated DC/DC Converters](#) category:

Click to view products by [XP Power](#) manufacturer:

Other Similar products are found below :

[ESM6D044440C05AAQ](#) [FMD15.24G](#) [PSL486-7LR](#) [Q48T30020-NBB0](#) [JAHW100Y1](#) [SPB05C-12](#) [SQ24S15033-PS0S](#) [18952](#) [19-130041](#)
[CE-1003](#) [CE-1004](#) [GQ2541-7R](#) [RDS180245](#) [MAU228](#) [J80-0041NL](#) [DFC15U48D15](#) [XGS-0512](#) [XGS-1205](#) [XGS-1212](#) [XGS-2412](#) [XGS-2415](#) [XKS-1215](#) [06322](#) [NCT1000N040R050B](#) [SPB05B-15](#) [SPB05C-15](#) [L-DA20](#) [DCG40-5G](#) [QME48T40033-PGB0](#) [XKS-2415](#) [XKS-2412](#)
[XKS-1212](#) [XKS-1205](#) [XKS-0515](#) [XKS-0505](#) [XGS-2405](#) [XGS-1215](#) [XGS-0515](#) [PS9Z-6RM4](#) [73-551-5038I](#) [AK1601-9RT](#) [VI-N61-CM](#) [VI-R5022-EXWW](#) [PSC128-7iR](#) [RPS8-350ATX-XE](#) [DAS1004812](#) [PQA30-D24-S24-DH](#) [VI-M5F-CQ](#) [VI-LN2-EW](#) [VI-PJW01-CZY](#)