

10W

DC-DC CONVERTER

The JMR10 series is a range of ultra-compact, regulated PCB-mount medical DC-DC converters which offers single and dual output voltages ranging from 5V to 15V. Housed in a ultra-compact DIP24 package, the JMR10 series features a 4:1 input voltage range and offers a $\pm 10\%$ output trim on single output versions. Its low no load power increases efficiency and extends runtime in battery powered applications. The JMR10 series features worldwide medical approvals, 2 x MOPP 5kVAC reinforced isolation and extremely low leakage currents benefitting system designers with easy integration into a wide range of BF and CF rated medical applications including imaging, patient monitoring, surgical equipment, patient treatment and dentistry.



Features

- Regulated single & dual outputs from 5 to 30VDC
- 4:1 input range
- Ultra-compact DIP24 PCB mount package
- Low no-load power
- 10% trim on single output versions
- IEC60601-1 medical safety agency approvals
- 5kVAC reinforced isolation
- 2 x MOPP at 250VAC
- 2 μ A patient leakage current
- Remote On/Off
- Short circuit, overload & overvoltage protection
- -40°C to +100°C operating temperature
- 3 year warranty

Dimensions

31.8 x 20.3 x 10.2mm (1.25" x 0.8" x 0.4")

Applications



Healthcare



Home Healthcare



Industrial Electronics



Medical Diagnostics

More Resources

Click the link or scan the code

[→ xppower.com](https://www.xppower.com)



Models & Ratings

Model Number	Input Voltage	Output Voltage ⁽¹⁾	Output Current	Efficiency ⁽³⁾	Input Current ⁽⁴⁾		Maximum Capacitive Load
					No Load	Full Load	
JMR1012S05	12V (4.5-18V)	5V	2000mA	84.5%	20mA	987mA	3300 μ F
JMR1012S12		12V	833mA	86.5%	20mA	964mA	470 μ F
JMR1012S15 ⁽⁵⁾		15V	666mA	87%	20mA	957mA	330 μ F
JMR1012D05 ⁽⁵⁾		$\pm 5V$	$\pm 1000mA$	84.5%	20mA	987mA	$\pm 1470\mu F$
JMR1012D12		$\pm 12V$	$\pm 416mA$	86.5%	20mA	962mA	$\pm 680\mu F$
JMR1012D15	$\pm 15V$	$\pm 333mA$	87%	20mA	957mA	$\pm 390\mu F$	
JMR1024S05	24V (9.0-36.0V)	5V	2000mA	85%	6mA	491mA	3300 μ F
JMR1024S12		12V	833mA	88%	6mA	474mA	470 μ F
JMR1024S15 ⁽⁵⁾		15V	666mA	89%	6mA	469mA	330 μ F
JMR1024D05 ⁽⁵⁾		$\pm 5V$	$\pm 1000mA$	85%	6mA	491mA	$\pm 1470\mu F$
JMR1024D12		$\pm 12V$	$\pm 416mA$	88%	6mA	473mA	$\pm 680\mu F$
JMR1024D15	$\pm 15V$	$\pm 333mA$	89%	6mA	468mA	$\pm 390\mu F$	
JMR1048S05	48V (18.0-75.0V)	5V	2000mA	85%	4mA	246mA	3300 μ F
JMR1048S12		12V	833mA	88%	4mA	237mA	470 μ F
JMR1048S15 ⁽⁵⁾		15V	666mA	88%	4mA	237mA	330 μ F
JMR1048D05 ⁽⁵⁾		$\pm 5V$	$\pm 1000mA$	85%	4mA	246mA	$\pm 1470\mu F$
JMR1048D12		$\pm 12V$	$\pm 416mA$	88%	4mA	237mA	$\pm 680\mu F$
JMR1048D15	$\pm 15V$	$\pm 333mA$	88%	4mA	237mA	$\pm 390\mu F$	

Notes:

1. Dual output models can be used to provide a single output of 10V, 24V or 30V.
2. Specifications noted using nominal input voltage and full load at 25°C unless otherwise stated.

3. Measured at full load and nominal input voltage.
4. No load input current reduces to <3mA when module is inhibited.
5. Available for OEM quantities, please contact sales.

Input

Characteristic	Minimum	Typical	Maximum	Units	Notes & Conditions
Input Voltage Range	4.5		18	VDC	12V nominal
	9		36		24V nominal
	18		75		48V nominal
Inrush Current			80	A	At nominal input voltage
Input Reflected Ripple		20		mA pk-pk	Through 12 μ H inductor and 47 μ F capacitor
Input Surge			25	VDC for 100ms	12V nominal
			50		24V nominal
			100		48V nominal
Input Current Remote On/Off		2.5	8.0	mA	Idle current using remote "Off". See models and ratings table for no load input current with module "On"
Recommended Input Fuse (Slow blow)		5.0		A	12V nominal
		2.0			24V nominal
		1.0			48V nominal

Output

Characteristic	Minimum	Typical	Maximum	Units	Notes & Conditions
Output Voltage	5		30	VDC	See Models & Ratings table
Output Voltage Adjustment	-10		+10	%	See application note
Initial Set Accuracy			± 1	%	At full load
Minimum Load	0			%	No minimum load required
Line Regulation			± 0.5	%	From min to max input voltage
Load Regulation			± 1.0	%	From 0-100% load
Cross Regulation			± 5	%	Dual output, when one output at 25% load other is varied from 10% to full load
Transient Response Deviation	3		5	%	Deviation recovering to within 1% in 250 μ s for 25% load change at 0.1A/ μ s
Ripple & Noise			75/100	mV pk-pk	5V/12-15V outputs, 20MHz bandwidth, measured using 10 μ F ceramic capacitor at nominal Vin
Short Circuit Protection	Continuous, hiccup mode with auto recovery				
Maximum Capacitive Load	See Models & Ratings table				
Temperature Coefficient			0.02	%/°C	
Overload Protection		160		%	At nominal input voltage
Remote On/Off	Output is on if remote on/off (pin 1) is open with reference to pin 2 -Vin Output turns off if 2.2 to 12V is applied to remote On/Off (pin 1) or if connected to a current source of 2-4mA. See application note				

General

Characteristic	Minimum	Typical	Maximum	Units	Notes & Conditions
Efficiency		87		%	See Models & Ratings table
Isolation: Input to Output	5000			VAC	Reinforced insulation, 2 x MOPP, 60s, production test to 5kVAC
Working Voltage			250	VAC	
Creepage and Clearance	8			mm	
Isolation Resistance	10 ⁹			Ω	Input to output
Isolation Capacitance		17		pF	Input to output
Leakage Current		2		μ A	264VAC, 60Hz
Power Density			1.5	Wcm ³	
Mean Time Between Failure	650			khrs	MIL-HDBK-217F, +25°C GB
Switching Frequency		300		kHz	
Weight		14.0 (0.003)		g (lb)	
Solder Profile			260	°C	Waveflow. 1.5mm (0.05") from case, 10 seconds max.
Case Material	Non conductive black plastic UL94V-0 rated				
Potting Material	Silicone, UL94V-0 rated				
Pin Material	Solder coated brass dia. 0.5mm				
Water Wash	Use deionized water. Dry thoroughly				

Environmental

Characteristic	Minimum	Typical	Maximum	Units	Notes & Conditions
Operating Temperature	-40		+100	°C	See derating curve
Storage Temperature	-55		+125	°C	
Case Temperature			+110	°C	At nominal input voltage
Humidity Operating & Storage	5		95	%RH	Non-condensing
Cooling	Natural convection				
Operating Altitude			5000	m	Transport altitude 10km

Safety Approvals

Safety Agency	Standard	Notes & Conditions
UL	ANSI/AAMI ES60601-1, UL62368-1	
CSA	CSA C22.2 No. 60601-1	
TUV	EN60601-1	
CB	IEC/EN60601-1	
CE	Meets all applicable directives	
UKCA	Meets all applicable legislation	

EMC: Emissions

Phenomenon	Standard	Test Level	Notes & Conditions
Conducted	EN55011	Class B	See application notes
Radiated	EN55011	Class B	

EMC: Immunity

Phenomenon	Standard	Test Level	Criteria	Notes & Conditions
Medical Device EMC	EN60601-1-2: 2015			IEC60601-1-2:2014 Ed4.0
ESD Immunity	EN61000-4-2	±8kV	A	Contact
		±15kV		Air
Radiated Immunity	EN61000-4-3	10V/m	A	
EFT/Burst	EN61000-4-4	±2kV	A	External component required, see application notes
Surge	EN61000-4-5	±2kV	A	External component required, see application notes
Conducted Immunity	EN61000-4-6	10Vrms	A	
Magnetic Fields	EN61000-4-8	100A/m	A	

Mechanical Details

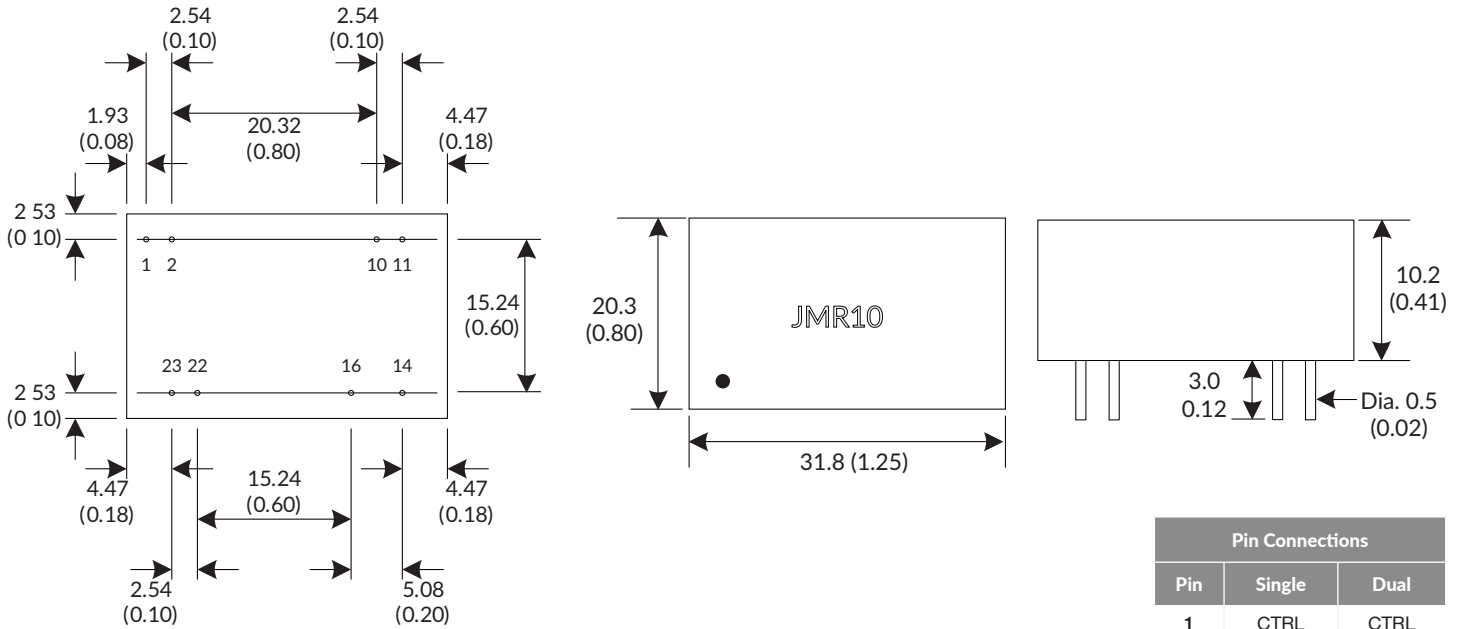

Recommended PCB Footprint

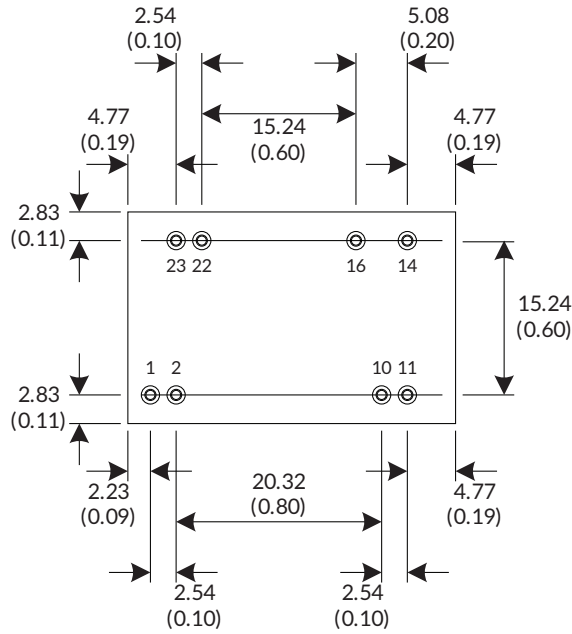

There should be at least 8mm distance between primary and secondary circuit.

Through hole diameter 0.8mm (0.031")
 Pad diameter top side 1.0mm (0.039")
 Pad diameter bottom side 2.0mm (0.079")

Pin Connections		
Pin	Single	Dual
1	CTRL	CTRL
2	-Vin	-Vin
10	Trim	Trim
11	NC	-Vout
14	+Vout	+Vout
16	-Vout	COM
22	+Vin	+Vin
23	+Vin	+Vin

Notes:

- All dimensions are in mm (inches)
- Weight: 14.0 (0.03) g (lbs) approx.
- Pin diameter: $\pm 0.002, 0.02 (\pm 0.05, 0.5)$
- Pin pitch tolerance: $\pm 0.35 (\pm 0.014)$
- Case tolerance: $\pm 0.5 (\pm 0.02)$

Application Notes

EMC Filter

Circuit 1 for Surge & EFT, 2 for EMI class B.

Single Output

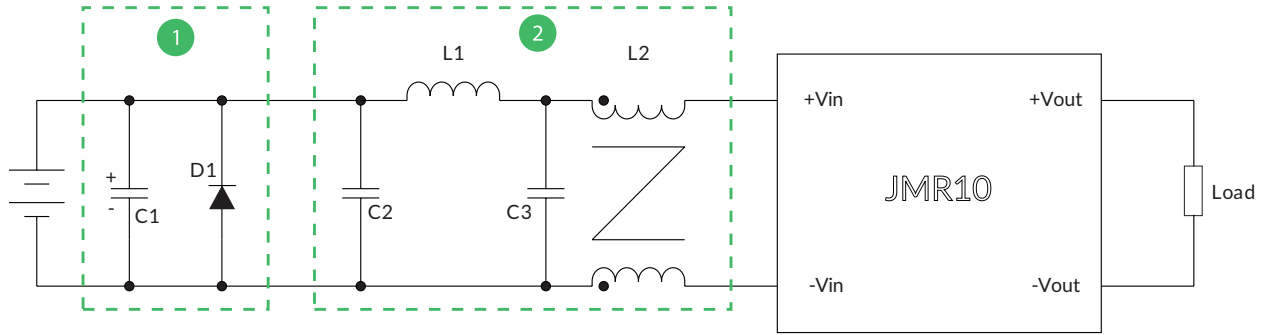

Model Number	D1	C1 ⁽¹⁾	C2, C3	L1	L2
JMR1012XXX	SMDJ26A	470 μ F/100V	MLCC, 22 μ F, 35V	2.2 μ H	LFD648074-52UH-3.14A
JMR1024XXX	SMDJ58A	330 μ F/100V	MLCC, 4.7 μ F, 50V	4.7 μ H	LFD649075-175UA-1.76A
JMR1048XXX	SMDJ120A	330 μ F/100V	MLCC, 2.2 μ F, 100V	6.8 μ H	LFD649075-419UH-0.78A

⁽¹⁾ Nippon CHEMI-CON KY series

Remote On/Off

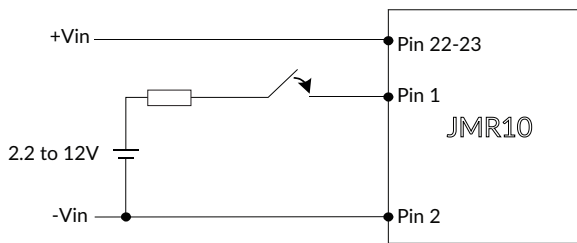

Module "On" if pin 1 is open circuit
 Module "Off" if pin 1 is connected to current source of 2-4mA, or a voltage of 2.2 to 12V is applied to pin 1 WRT pin 2.

Application Notes

Derating Curves

JMR1012S05, JMR1012D05, JMR1024S05, JMR1024D05

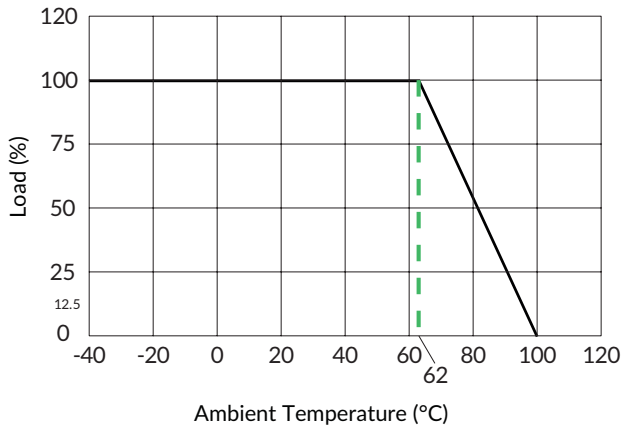

JMR1012S12, JMR1012D12, JMR12S15, JMR12D15

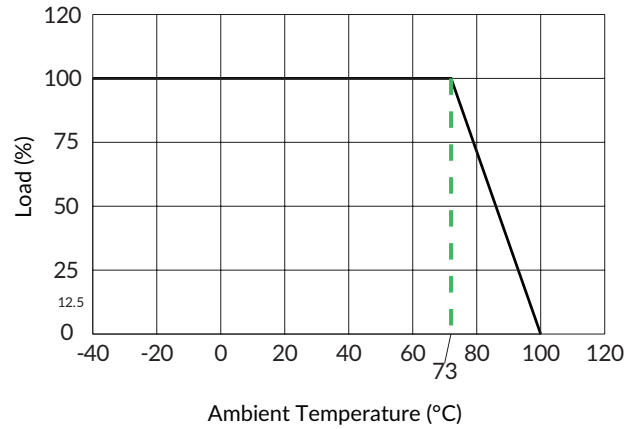

JMR1048S05, JMR1048D05

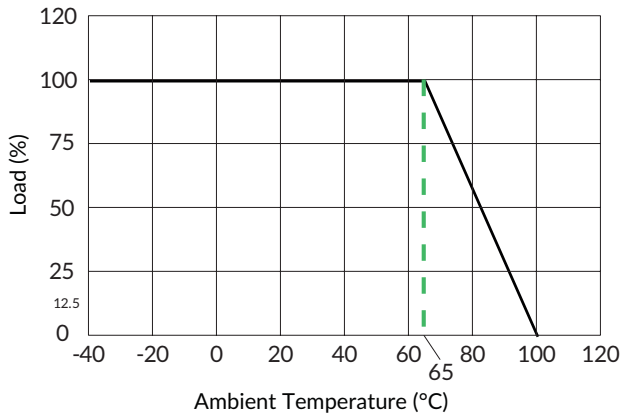

JMR1024S12, JMR1024S15, JMR1024D12, JMR1024D15,
JMR1048S12, JMR1048S15, JMR1048D12, JMR1048D15

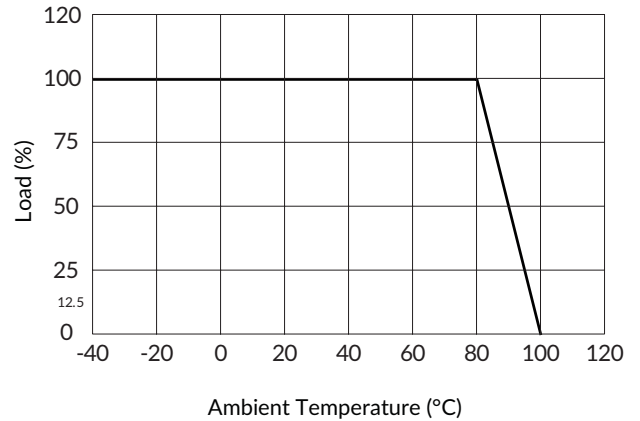

X-ON Electronics

Largest Supplier of Electrical and Electronic Components

Click to view similar products for [Isolated DC/DC Converters - Through Hole category](#):

Click to view products by [XP Power manufacturer](#):

Other Similar products are found below :

[R-78E3.3-0.5](#) [K7805-500R3](#) [B0524XT-1WR3](#) [B2424S-3WR2](#) [F0505D-1WR2](#) [K7805-1000R3](#) [LZ4644IY#PBF](#) [K7812-500R3](#) [B1205S-1W](#)
[R-78E12-0.5](#) [K7805M-1000R3](#) [B1224XT-1WR3](#) [H1205S-2WR2](#) [K7812-1000R3](#) [B1205S-2W](#) [R-78E5.0-0.5](#) [R-78E9.0-0.5](#) [B0503XT-2WR2](#)
[B1505S-3WR2](#) [RSK-2405SRUW/H3](#) [CCG3-48-12SF](#) [CCG6-12-05SF](#) [RSOK-2405SZ/H3](#) [CQB100W14-72S15](#) [TRI 1-2413](#) [CCG6-24-15DF](#)
[TRI 1-1211SM](#) [CCG6-24-12DF](#) [RYK-053.3S/H](#) [MGJ2D241802BSC](#) [MGJ2D122003BSC](#) [EC4BE13](#) [PXD40-24WD15](#) [CCG1R5-12-03SF](#)
[MGJ2D242005BSC](#) [TRI 1-2412SM](#) [TRI 1-1212](#) [EC5DAW-48S12N](#) [RP06-11005SRAW](#) [TRI 1-1213](#) [TRI 1-1211](#) [R2M-2412D](#) [PXD40-](#)
[24WD12](#) [CCG10-24-15DF](#) [EC5DAW-24D15N](#) [TRI 1-1212SM](#) [CCG1R5-24-05SF](#) [CCG10-48-03SF](#) [PXD60-48WD24](#) [CQB100W14-72S15N](#)