

LCL Series



- Single Output Industrial Supplies
- High Efficiency
- Low Cost
- 150 W Convection Cooled
- 500 W with Internal Fans
- Outputs form 12 V to 48 V
- 3 Year Warranty

The LCL series is a low cost chassis mount product that is popular in industrial applications. The AC/DC supplies are enclosed in a metal case with terminal block input and output connectors. Three series offer 150 and 500 Watts. Each power range includes six single output models from 12 to 48 VDC. The user adjustable outputs cover all nominal voltage ranges. The LCL150 is convection cooled while the 500 Watt has an internal fan.

All LCL models are approved to ITE (62368-1) safety standards and meet EN55032 Level B conducted emissions. Operating temperature range is from -10 °C to +70 °C with derating above +50 °C. Standard features include overvoltage, overload, short circuit, and over temperature protection. Remote sense is included on the LCL500 with Remote On/Off available.

Models and Ratings

Output Power	Output Voltage	Trim Range	Output Current	Ripple & Noise ⁽¹⁾	Model Number
150 W	12.0 V	11.0-13.0 V	12.5 A	100 mV pk-pk	LCL150PS12
	13.5 V	12.5-14.5 V	11.1 A	100 mV pk-pk	LCL150PS13
	15.0 V	14.0-16.0 V	10.0 A	100 mV pk-pk	LCL150PS15
	24.0 V	23.0-25.0 V	6.3 A	150 mV pk-pk	LCL150PS24
	27.0 V	26.0-28.0 V	5.6 A	150 mV pk-pk	LCL150PS27
	48.0 V	47.0-49.0 V	3.1 A	250 mV pk-pk	LCL150PS48
500 W	12.0 V	11.0-13.0 V	42.0 A	120 mV pk-pk	LCL500PS12
	13.5 V	12.5-14.5 V	37.0 A	150 mV pk-pk	LCL500PS13
	15.0 V	14.0-16.0 V	34.0 A	150 mV pk-pk	LCL500PS15
	24.0 V	23.0-25.0 V	21.0 A	150 mV pk-pk	LCL500PS24
	27.0 V	26.0-28.0 V	18.5 A	150 mV pk-pk	LCL500PS27
	48.0 V	47.0-49.0 V	10.5 A	240 mV pk-pk	LCL500PS48

Notes:

1. Measured with 20 MHz bandwidth.

Input Characteristics

Characteristic	Minimum	Typical	Maximum	Units	Notes & Conditions
Input Voltage - Operating	85		264	VAC	Derate output power < 90 VAC. See fig. 1.
Input Frequency	47		63	Hz	
Power Factor		>0.9			EN61000-3-2 class A compliant LCL150: EN61000-3-2 class C for loads ≥40% LCL500: EN61000-3-2 class C for loads ≥40%
Input Current - Full Load			2.1 6.6	A	LCL150 at 90 VAC LCL500 at 90 VAC
Inrush Current			50 60	A	LCL150, 230 VAC, cold start 25 °C LCL500, 230 VAC, cold start 25 °C
Earth Leakage Current			<2	mA	264 VAC/60 Hz
Input Protection	T3.15 A/250 V internal in-line fuse				LCL150
	T10 A/250 V internal in-line fuse				LCL500

Input Derating Curve

Figure 1

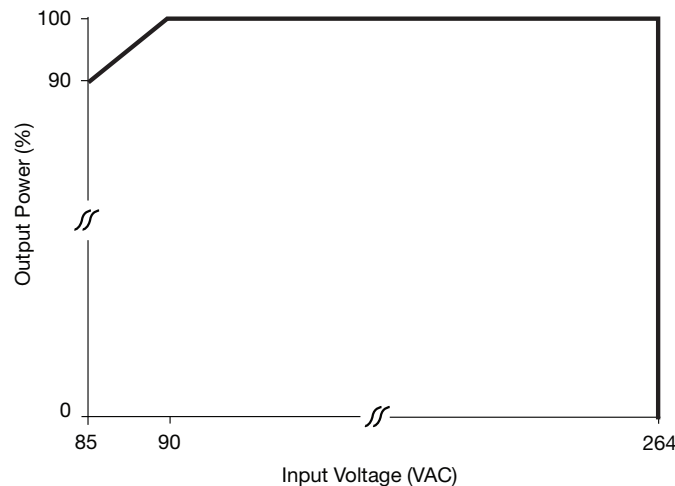

Output Characteristics

Characteristic	Minimum	Typical	Maximum	Units	Notes & Conditions
Output Voltage - V1	12		48	VDC	See Models and Ratings table
Initial Set Accuracy			±100	mV	50% load
Output Voltage Adjustment	±1			V	See Models and Ratings table
Minimum Load	0			A	
Start Up Delay			2	s	
Start Up Rise Time			65	ms	LCL150
			35		LCL500
Hold Up Time	10			ms	115 VAC full load
Line Regulation			±0.5	%	LCL150
			±0.3		LCL500
Load Regulation			±1	%	
Transient Response			4	%	Recovery within 1% in less than 500 μs for a 50% load change
Ripple & Noise					See Models and Ratings table
Overvoltage Protection	110		140	%	Recycle input to reset
Overload Protection	110		150	%	Rated output power, delayed by 1 s minimum to allow peak loads. See fig 2 & 3
Short Circuit Protection					Auto recovery, hiccup mode
Overtemperature Protection					Output turns off when OTP triggered, measured internally (Q1 temperature), auto recover when internal temperature was reduced.

Output Overload Characteristics

Figure 2 - LCL150PS12

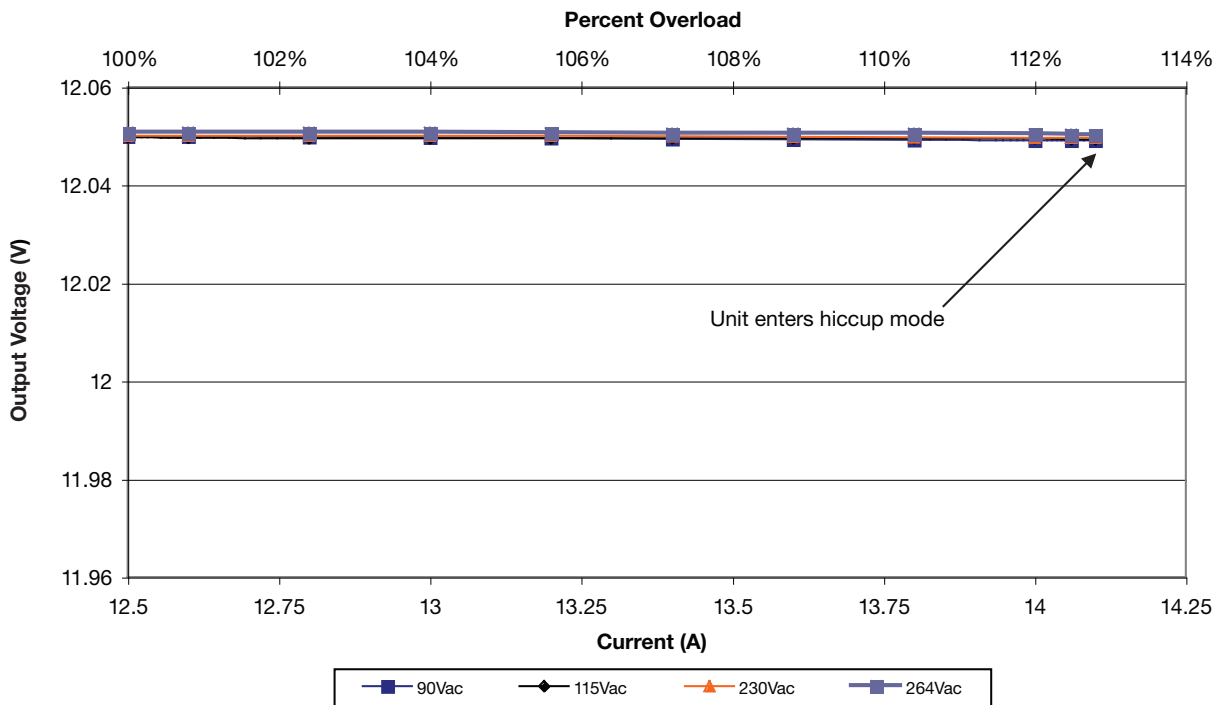

Output Overload Characteristics

Figure 3 - LCL500PS48

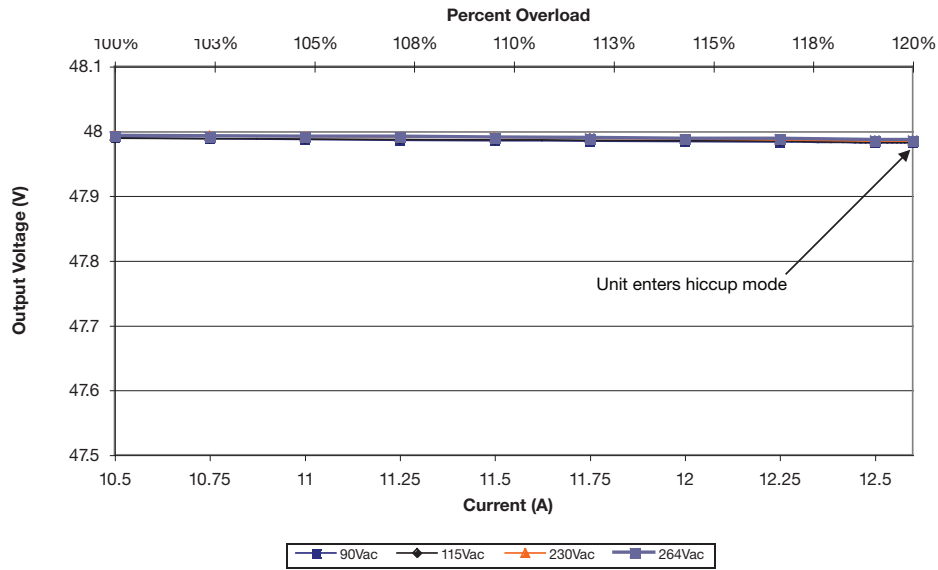

General Specifications

Characteristic	Minimum	Typical	Maximum	Units	Notes & Conditions	
Efficiency	85	88		%	230 VAC full load. See fig. 2 & 3	
Isolation: Input to Output	3000			VAC		
Input to Ground	1500					
Output to Ground	500					
Switching Frequency	45		190	kHz	PFC Converter	LCL150
	90		110		Main Converter	
	62		65		PFC Converter	LCL500
	80		190		Main converter	
Power Density			2.7	W/in ³	LCL150	
			4.9		LCL500	
MTBF		200		kHrs	MIL-HDBK-217F at 25 °C, GB	
Weight			1.39 (630)	lb (g)	LCL150	See mechanical details
			3.2 (1.45)	lb (kg)	LCL500	

Efficiency vs Load

Figure 4 - LCL150PS12

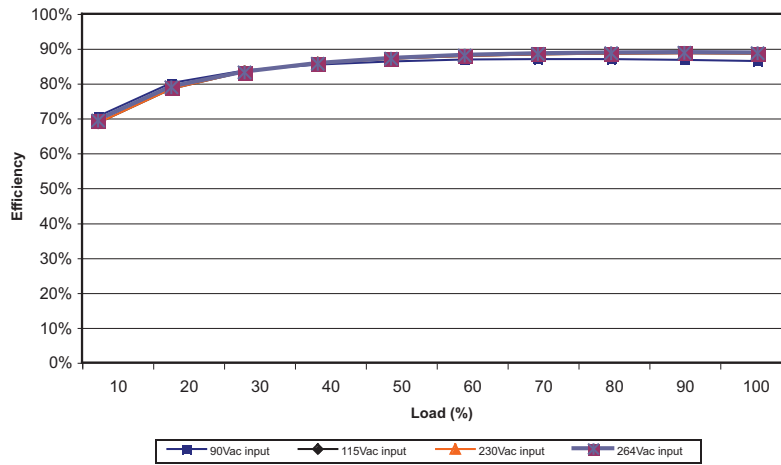
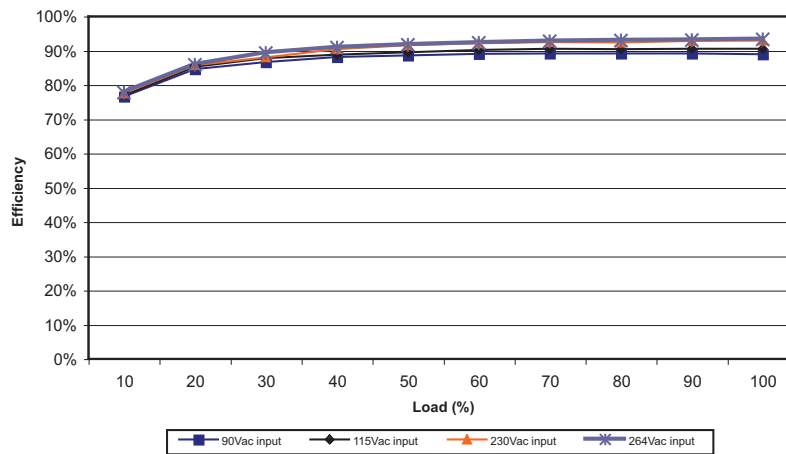

Figure 5 - LCL500PS48



Signals & Controls

Characteristics	Notes and Conditions
Remote Sense	Compensates for 0.25 V max each line. Fitted to LCL500 only.
Remote On/Off	Fitted on LCL500. On = logic low or open circuit, OFF = logic high

Figure 6 - Remote Sense Connection Diagram

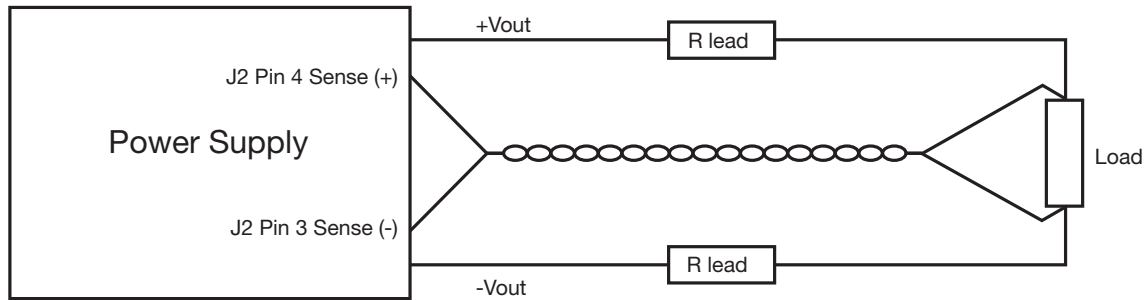
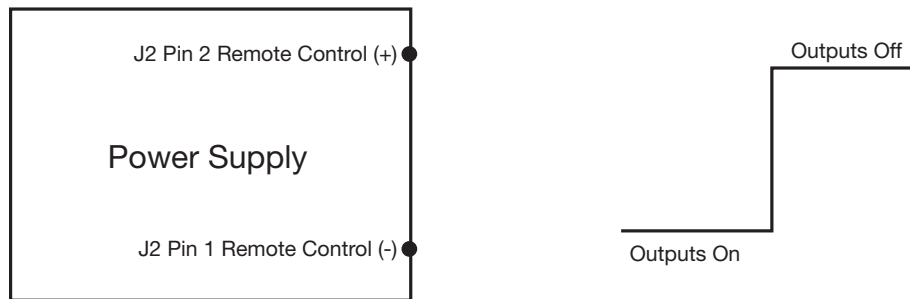

Figure 7 - Remote On/Off



1. Applying $<0.8\text{ V}$ on Pin 2 with respect to Pin 1 or open circuit, output turns ON.
2. Applying $>4.5\text{ V}$ on Pin 2 with respect to Pin 1, output turns OFF

Environmental

Characteristic	Minimum	Typical	Maximum	Units	Notes & Conditions
Operating Temperature	-10		70	°C	LCL150: Derates linearly from 100% load at 50 °C to 50% load at 70 °C (see fig. 8). At -10 °C, 90 VAC, start up time increases to 4 s (LCL150)
					LCL500: Derates linearly from 100% load at 55 °C to 50% load at 70 °C (see fig. 9). At -10 °C, 90 VAC, start up time increases to 5 s.
Storage Temperature	-40		85	°C	
Cooling					LCL150 convection cooled, & LCL500 has internal fan.
Humidity	5		95	%RH	Non-condensing
Operating Altitude			3000	m	
Vibration	2			g	10-500 Hz, 10 mins per cycle on 3 axes

Temperature Derating Curve

Figure 8 - LCL150

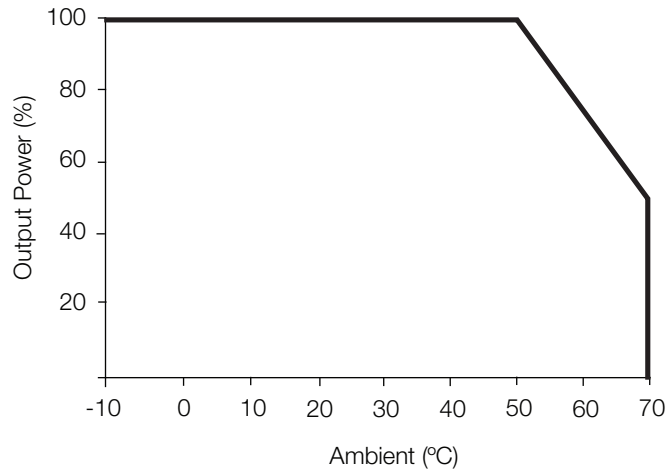
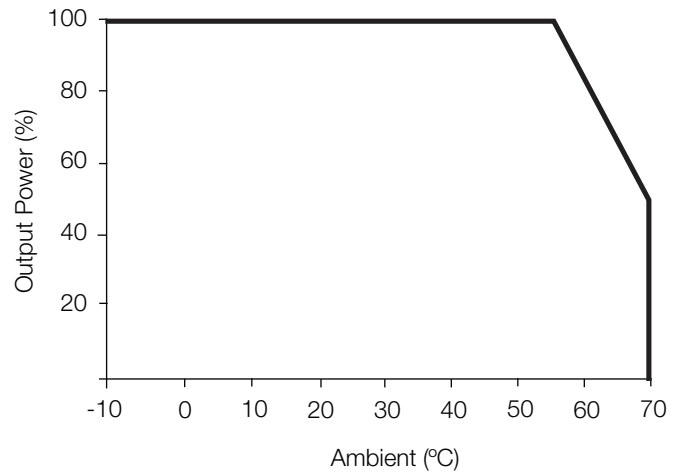

Figure 9 - LCL500



Electromagnetic Compatibility - Immunity (high severity level, EN61204-3)

Phenomenon	Standard	Test Level	Criteria	Notes & Conditions
ESD	EN61000-4-2	±4 kV	A	Contact Discharge
		±8 kV		Air Discharge
		±8 kV		Coupling Plane Discharge
Radiated RF	EN61000-4-3	2	A	
EFT	EN61000-4-4	2	A	
Surge	EN61000-4-5	Installation Class 3	A	LCL150
		Installation Class 2		LCL500
Conducted RF	EN61000-4-6	2	A	
Magnetic Field	EN61000-4-8	1 A/m	A	
Dips and Interruptions	EN61000-4-11	Dip: 30% 10 ms	A	
		Dip: 60% 100 ms	B	
		Dip: 100% 5000 ms	B	

ESD Points

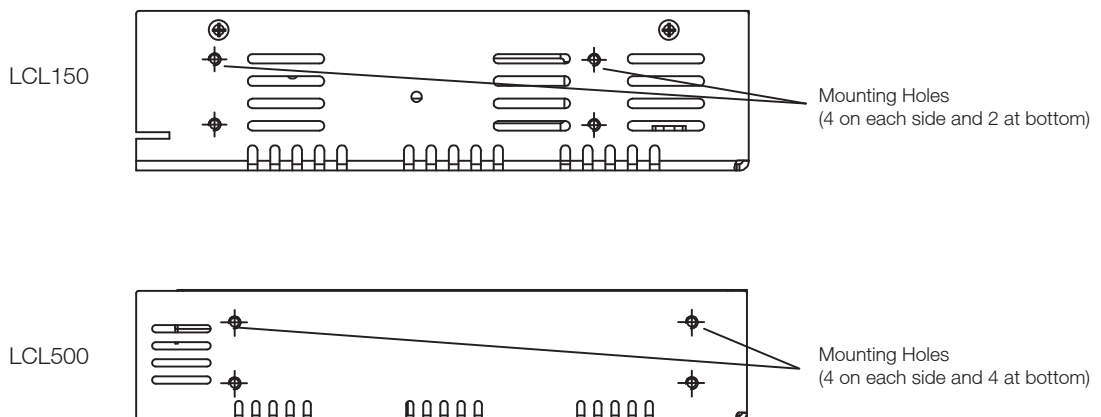

10 discharges at each polarity were applied at points indicated (contact and air discharges)

Electromagnetic Compatibility - Emissions

Phenomenon	Standard	Test Level	Criteria	Notes & Conditions
Conducted	EN55032	Class B		
Radiated	EN55032	Class A		
Harmonic Currents	EN61000-3-2	Class A Equipment		

Conducted Emission Plots

Figure 10 - QP Detector - LCL150PS12

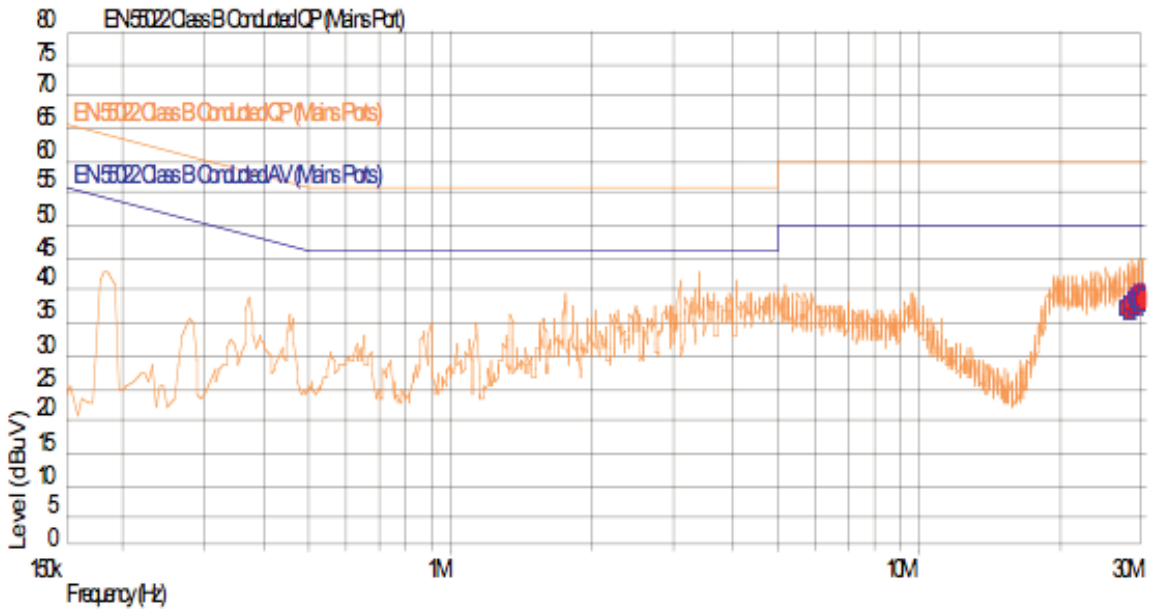
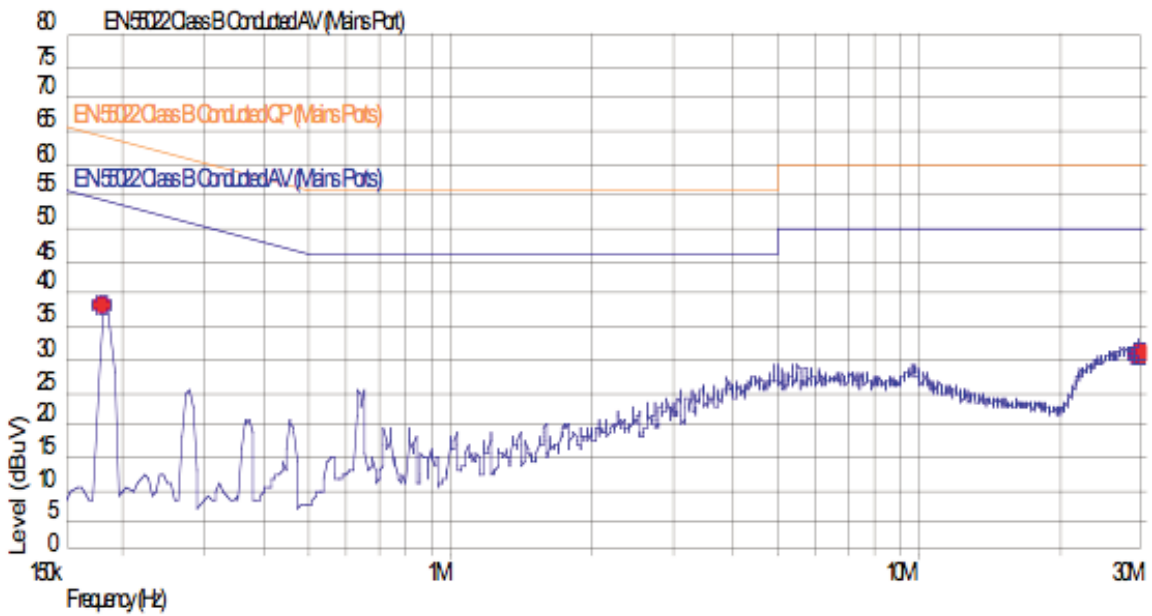

Figure 11 - AV Detector - LCL150PS12



Conducted Emission Plots

Figure 12 - QP Detector - LCL500PS48

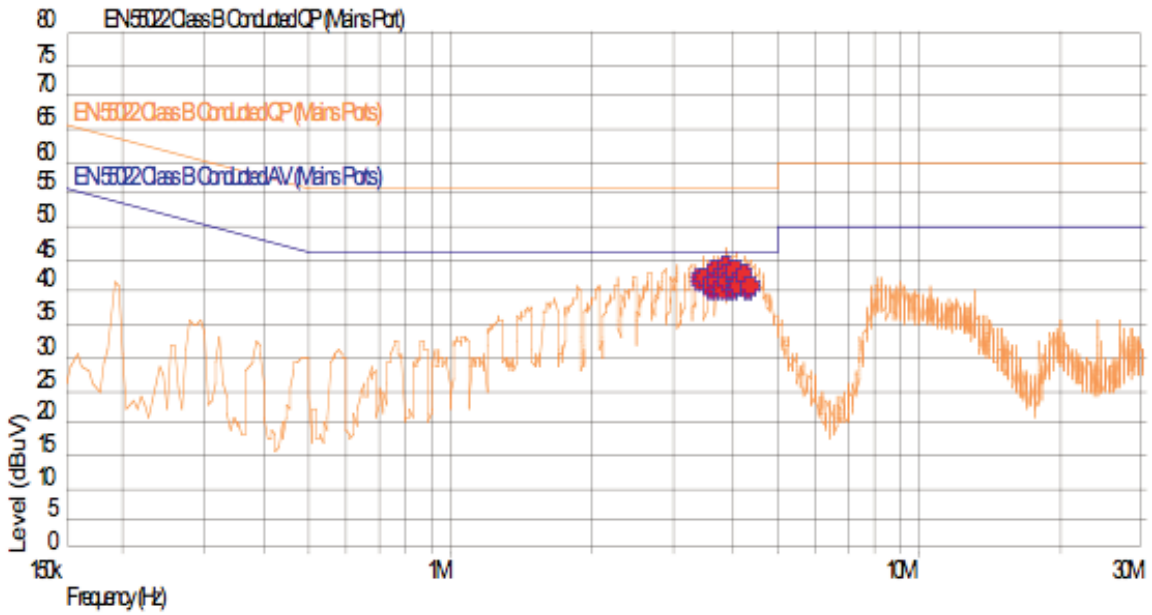
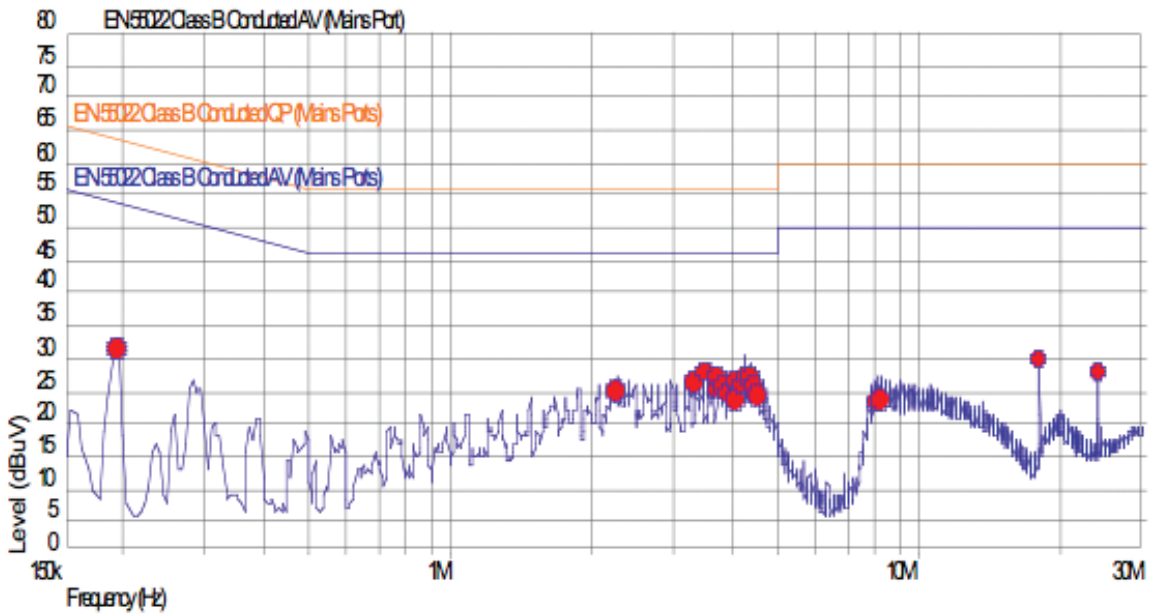

Figure 13 - AV Detector - LCL500PS48



Safety Agency Approvals

Safety Agency	Safety Standard	Category
CB Report	IEC62368-1	Informations Technology
UL	UL62368-1 CSA62368-1 via cUL	Informations Technology
TUV	EN62368-1	Informations Technology

Equipment Protection Class	Safety Standard	Notes & Conditions
Class I	IEC62368-1	See safety agency conditions of acceptability for details

Mechanical Details - LCL150

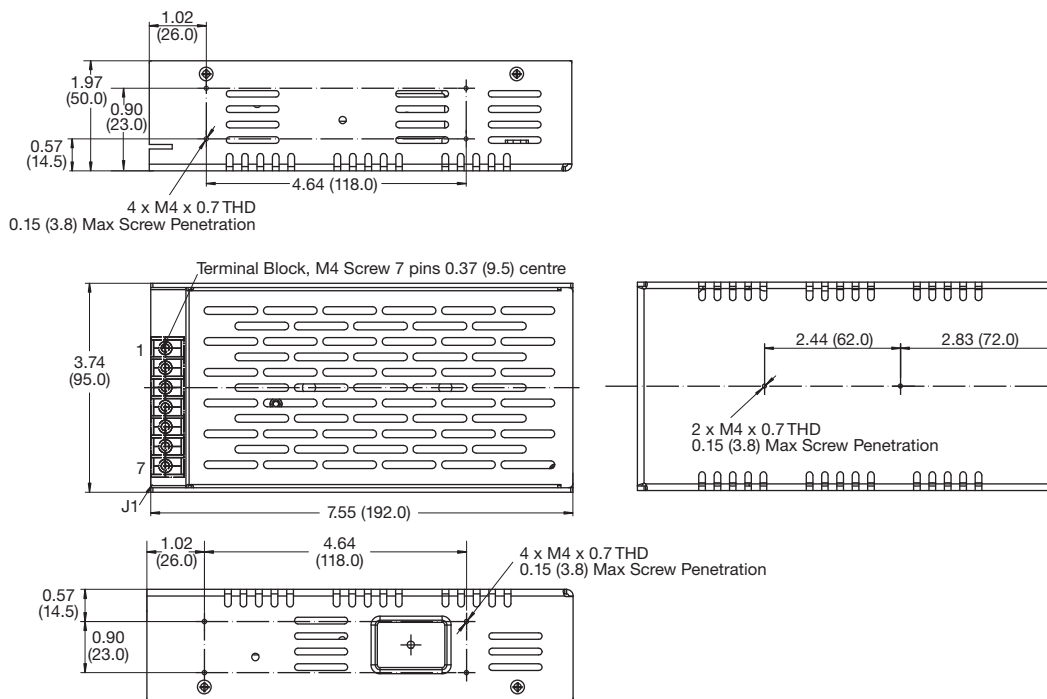

Notes: _____
 Weight: 1.39 lbs (630g) approx. Tolerance is ± 0.05 (± 0.2) maximum.
 Dimensions shown in inches (mm).

Pin	Function
1	+Vout
2	+Vout
3	-Vout
4	-Vout
5	Ground
6	AC Neutral
7	AC Live

LCL500

Weight: 3.2 lbs (1.45 kg) approx.
 Dimensions shown in inches (mm).
 Tolerance is ±0.05 (±0.2) maximum.

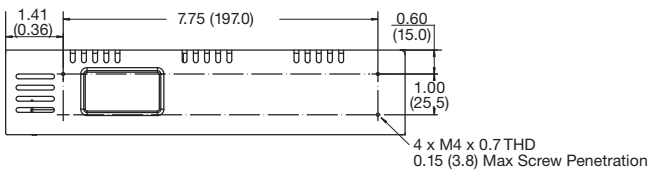
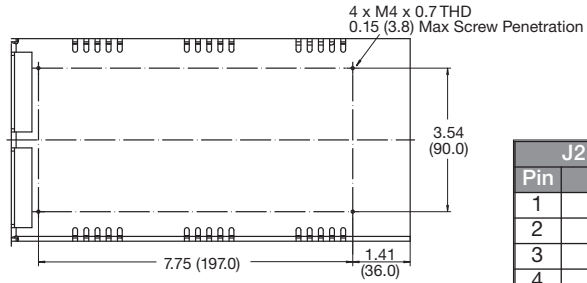
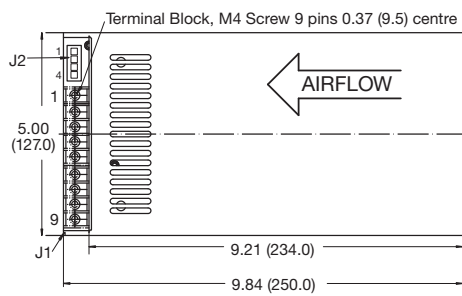
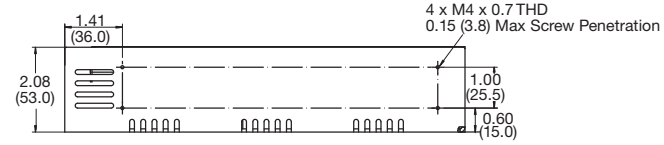

J1 Pin Connections	
Pin	Function
1	+Vout
2	+Vout
3	+Vout
4	-Vout
5	-Vout
6	-Vout
7	Ground
8	AC Neutral
9	AC Live

J2 Pin Connections	
Pin	Function
1	Remote Control -
2	Remote Control +
3	Sense -
4	Sense +

Applying >4.5 V to Pin 2 with respect to Pin 1 turns output off.
 Applying <0.8 V to Pin 2 with respect to Pin 1 or open circuit turns output on.

Mating Connectors (J2):
 WST P4-I25002 housing
 WST I25002BS contacts

X-ON Electronics

Largest Supplier of Electrical and Electronic Components

Click to view similar products for [Switching Power Supplies](#) category:

Click to view products by [XP Power](#) manufacturer:

Other Similar products are found below :

[70841011](#) [73-551-0005](#) [73-551-0048](#) [PS3E-B12F](#) [PS3E-E12F](#) [AAD600S-4-OP](#) [R22095](#) [KD0204](#) [9021](#) [LDIN100150](#) [LPM000-BBAR-01](#)
[LPX17S-C](#) [EVS57-10R6/R](#) [FP80](#) [FRV7000G](#) [22929](#) [PS3E-F12F](#) [CQM1IA121](#) [40370121900](#) [VI-PU22-EXX](#) [40370121910](#) [LDIN5075](#)
[LPM615-CHAS](#) [LPX140-C](#) [09-160CFG](#) [70841025](#) [VPX3000-CBL-DC](#) [VI-LUL-IU](#) [LPM000-BBAR-05](#) [LPM000-BBAR-08](#) [LPM124-](#)
[OUTA1-48](#) [LPM000-BBAR-07](#) [LPM109-OUTA1-10](#) [LPM616-CHAS](#) [08-30466-1055G](#) [08-30466-2175G](#) [08-30466-2125G](#) [DMB-EWG](#)
[TVQF-1219-18S](#) [6504-226-2101](#) [CQM1IPS01](#) [SP-300-5](#) [CQM1-IPS02](#) [VI-MUL-ES](#) [22829](#) [08-30466-0065G](#) [VI-RU031-EWWX](#) [08-30466-](#)
[0028G](#) [EP3000AC48INZ](#) [VP-C2104853](#)