

# MTF50



- MIL-STD 810 Environmental Performance
- 15 to 40 VDC Steady State Input Range
- 10 to 50 VDC Transient Input Range
- 50 W Max Output Power
- -55 °C to 100 °C Operation
- Cooling Plates and Mounting Holes for easy integration
- MIL-STD 461G EMI Performance
- MIL-STD 1275A-E & MIL-STD704A-F Immunity Performance
- Designed as a COTS component for Defense and Avionics applications

The MTF50 is a COTS EMC filter which has been developed specifically for the defense and avionics market. This product offers a high end specification while offering the short lead times and cost benefits of COTS components. The MTF50 is designed to filter the conducted emissions of the MTC series DC-DC Converters and protect against conducted susceptibility specified in MIL-STD-461G and surges and spikes specified in MIL-STD-1275A-E and MIL-STD-704A-F.

## Input Characteristics

Characteristic	Minimum	Typical	Maximum	Units	Notes & Conditions
Input Voltage	15.5	28	40	VDC	Continuous operation
Transient Input Voltage Range	10.0		50	VDC	10 secs max
Inrush Current	13.3	24.7	39.4	A	Peak value

## Output Characteristics

Characteristic	Minimum	Typical	Maximum	Units	Notes & Conditions
Maximum Output Voltage	44		47.5	VDC	Clamped <50 V
Nominal Output Voltage				VDC	Non regulated, output proportional to input: $V_{out} = V_{in} - I_{out} \times R_{series}$
Output Power			50.0	W	15.5-40.0 VDC input 10.0-15.5 VDC 10 secs max 40.0-50.0 VDC 10 secs max
Inhibit	Off = TTL low or short circuit, On = TTL high or open circuit				

## General Specifications

Characteristic	Minimum	Typical	Maximum	Units	Notes & Conditions
Efficiency		97.00		%	
Resistance		0.25			Input to output, case to case pin @ 10 A
Power Dissipation Inhibited		0.10		W	
Rth Case-Ambient		8.00		°C/W	
Fusing	External fusing required				
Reverse Voltage Protection	Needs to be provided externally, see safe operating area				
MTBF	See MTBF Calculations				

## Environmental

Characteristic	Minimum	Typical	Maximum	Units	Notes & Conditions
Operating Case Temperature	-40		+100	°C	Baseplate temperature
Extended Temperature Range	-55		+100	°C	Baseplate temperature <sup>(1)</sup>
Storage Temperature	-55		+100	°C	Ambient temperature
Humidity		88		%	Relative humidity
Altitude			70000	Ft	MIL-STD 810D Method 500.2
Shock		100		G	MIL-STD 810D Method 516.3 crash hazard for ground equipment
Vibration	5		500	Hz	MIL-STD 810D Method 514.3 3 g basic transportation
Bump		40		G	2000 bumps in each axes MIL-STD 810D Method 516.3 crash hazard

1. For -55 °C extended operating range, add suffix '-LT' to the part number. e.g. MTF50-LT.

## Electromagnetic Compatibility

	Standard	Test Level	Criteria	Notes & Conditions
Conducted Emissions	MIL-STD-461G	CE101/CE102		
Immunity	MIL-STD-1275A-E	Spikes Surges Ripple	±250 V for 100 µs 100 V for 50 ms at 0.5 14 VAC pk-pk	
	MIL-STD-704A/B-F	600 V input transient	10 µs 50 source impedance	
Conducted Susceptibility	MIL-STD-461G	CS101, CS114, CS115, CS116		

## Safety Approvals

Standard	Category
CE	LVD

Output Voltage	Input Voltage	Efficiency	Model Number
50 VDC max	15.5-40.0 VDC	97%	MTF50

## MTBF Calculations

Temperature / Environment	Ground Mobile - GM	Airborne Inhabited Cargo - AIC	Airborne Inhabited Fighter - AIF
20 °C	693264 Hrs	600672 Hrs	301882 Hrs
40 °C	471398 Hrs	410083 Hrs	203684 Hrs
60 °C	320466 Hrs	284139 Hrs	141178 Hrs
80 °C	218610 Hrs	199505 Hrs	100179 Hrs
100 °C	148081 Hrs	140201 Hrs	72052 Hrs

## Safe Operating Area

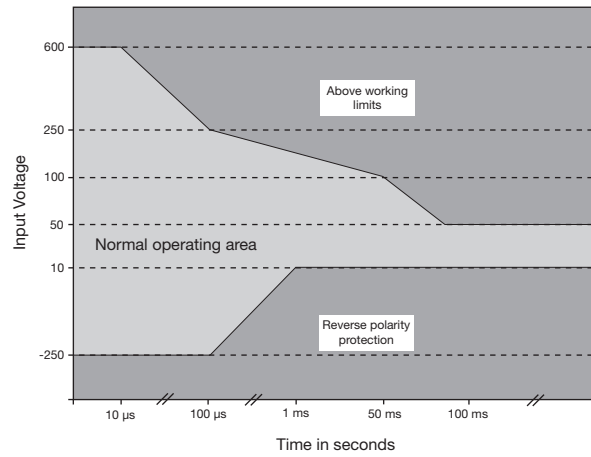

## Block Diagram

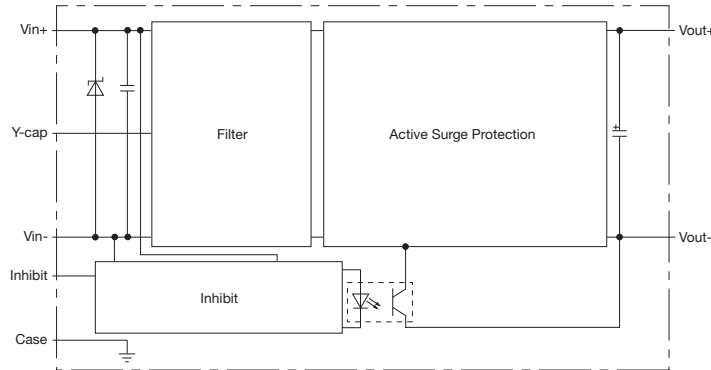

## EMC Connection Diagram

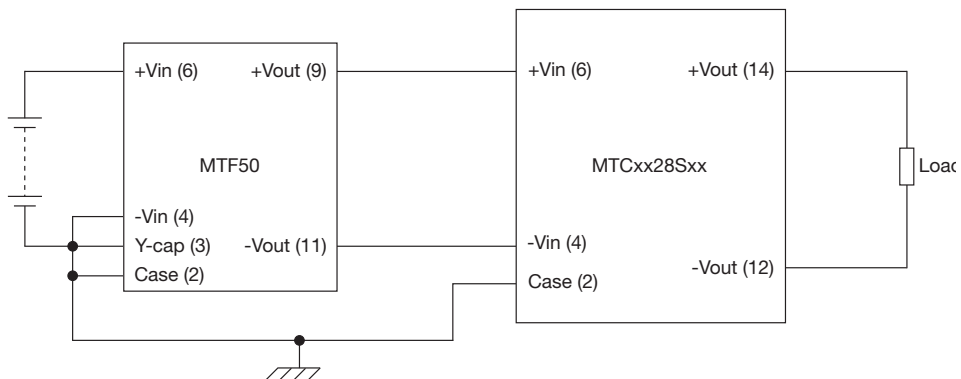

# Conducted Emissions

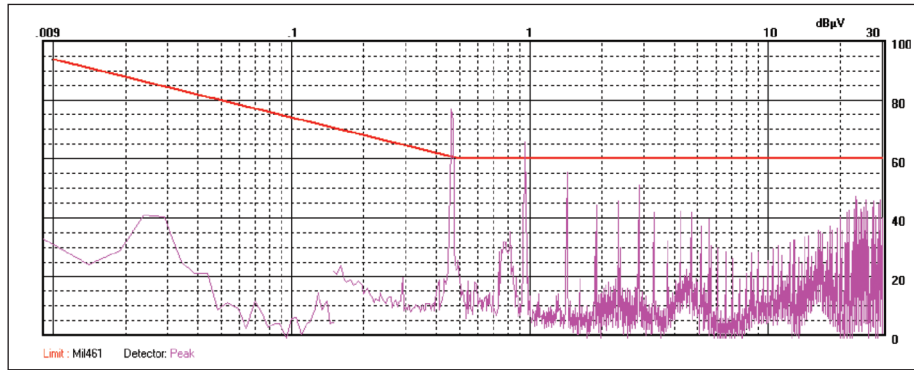

MTC0528S12 without MTF50 filter

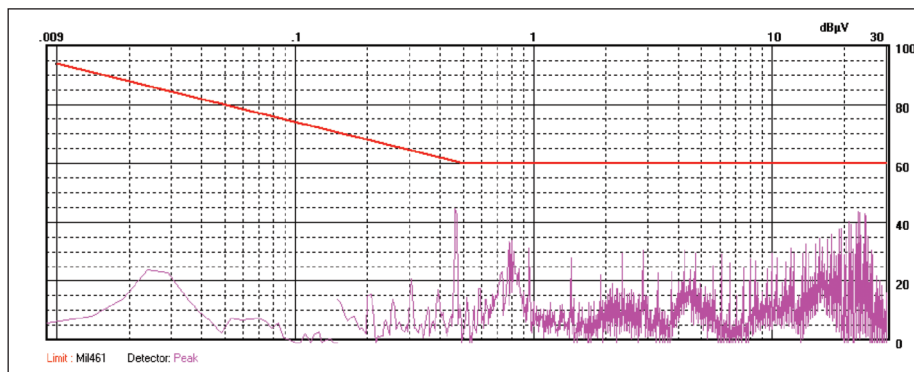

MTC0528S12 with MTF50 filter

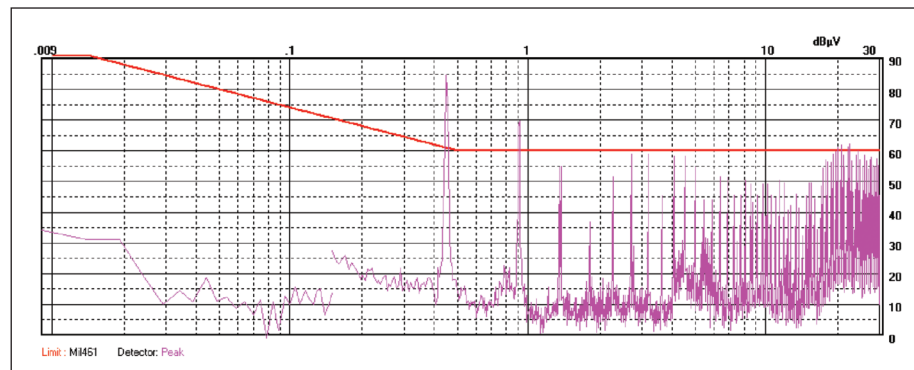

MTC1528S12 without MTF50 filter

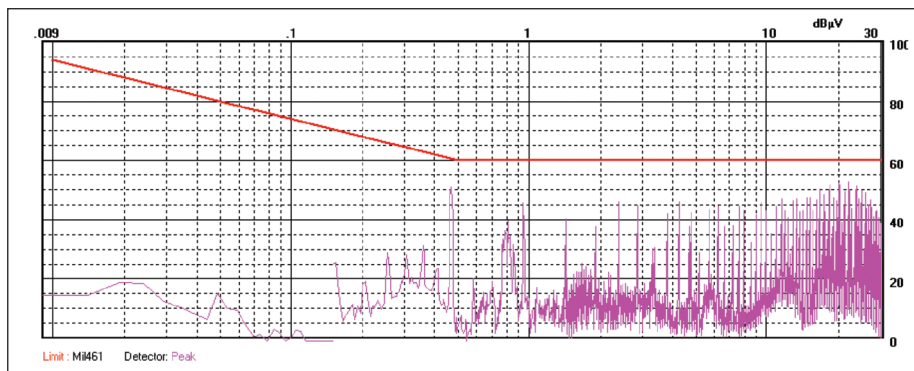

MTC1528S12 with MTF50 filter



## X-ON Electronics

Largest Supplier of Electrical and Electronic Components

*Click to view similar products for [Isolated DC/DC Converters](#) category:*

*Click to view products by [XP Power](#) manufacturer:*

Other Similar products are found below :

[ESM6D044440C05AAQ](#) [FMD15.24G](#) [PSL486-7LR](#) [Q48T30020-NBB0](#) [JAHW100Y1](#) [SPB05C-12](#) [SQ24S15033-PS0S](#) [18952](#) [19-130041](#)  
[CE-1003](#) [CE-1004](#) [GQ2541-7R](#) [RDS180245](#) [MAU228](#) [J80-0041NL](#) [DFC15U48D15](#) [XGS-0512](#) [XGS-1205](#) [XGS-1212](#) [XGS-2412](#) [XGS-2415](#) [XKS-1215](#) [06322](#) [NCT1000N040R050B](#) [SPB05B-15](#) [SPB05C-15](#) [L-DA20](#) [DCG40-5G](#) [QME48T40033-PGB0](#) [XKS-2415](#) [XKS-2412](#)  
[XKS-1212](#) [XKS-1205](#) [XKS-0515](#) [XKS-0505](#) [XGS-2405](#) [XGS-1215](#) [XGS-0515](#) [PS9Z-6RM4](#) [73-551-5038I](#) [AK1601-9RT](#) [VI-N61-CM](#) [VI-R5022-EXWW](#) [PSC128-7iR](#) [RPS8-350ATX-XE](#) [DAS1004812](#) [PQA30-D24-S24-DH](#) [VI-M5F-CQ](#) [VI-LN2-EW](#) [VI-PJW01-CZY](#)