

温控器系列 KSD301 试验报告

Test report of thermostat KSD301 series

客户名称 Customer	W. HQ	生产日期 Date:	2018-01-25
产品型号 Product model	KSD301	样品数量 Sample quantity:	5pcs
温度规格 Temperature specification	95/103PAK/18IB/RTG-WHQ	壳体材料 Shell material:	<input checked="" type="checkbox"/> 塑料 PF <input type="checkbox"/> 陶瓷 Ceramic <input type="checkbox"/> 高温塑料 PPS
动作温度 Switching temperature	95+/-3℃	端子: Tab	<input type="checkbox"/> 4.8mm <input checked="" type="checkbox"/> 6.3mm <input checked="" type="checkbox"/> 180o <input type="checkbox"/> 90 o <input type="checkbox"/> 20o <input type="checkbox"/> 45 o
复位温度 Reset temperature	80+/-5℃	特殊要求 Special request:	<input type="checkbox"/> 大铝盖 Big Aluminum cap with fixed bracket <input checked="" type="checkbox"/> 小铝盖带活动环 Small aluminum cap with moveable bracket <input type="checkbox"/> 小铝盖不带活动环 Small aluminum cap without movable bracket

技术说明

Technology of specification

接触电阻 Resistance of contact	≤50 mΩ
绝缘电阻 Resistance of Insulated	Dc 500V >100 MΩ
耐压 Test voltage	>AC 1500V/1Min
COC、TUV 参数 EnduranceCycles tested	AC250V 10A 100,000 cycles
VDE、UL 参数 EnduranceCycles tested	AC250V 10A 100,000 cycles

测试数据 Test data

NO.	动作温度 (℃) switching temperature	复位温度 (℃) Reset temperature	接触电阻 (mΩ) Resistance of contact	耐压 Test voltage	结论 conclusion
1	92-98	75-85	/	合格 (OK)	合格 (OK)
2	92-98	75-85		合格 (OK)	
3	92-98	75-85		合格 (OK)	
4	92-98	75-85		合格 (OK)	
5	92-98	75-85		合格 (OK)	

测试设备 Testing Device:

恒温测温桶: Thermostatic temperature measurement barrel;

温度异常时以我方测温为准: It is subject to our test temperature when the temperature anomalies

拟制(Prepared by): 刘春青 审核 (Checked by): 齐俊刚 审批(Approved by): 吴斌怀

技术要求 (Technology Specification)

1、电气性能 (Electric Performance):

额定电压/电流 (Rated Voltage/Current): 250V/10A

IP-防护等级 (Protection Degree): IP00级

寿命 (Operation Cycles): COC, TUV 10000

VDE, UL 100000

接触电阻 (Resistance of Contact): $\leq 50m\Omega$

绝缘电阻 (Resistance of Insulated): $\geq 100M\Omega$

耐压 (Test Voltage): $\geq 1500V/1min$ (Normality)

2、适用标准 (Relevant Standards)

UL873, CSA C22.2 NO 24-93

EN 60730-1 2012-10

EN 60730-2-9: 2011-07

GB14536.1-2008 idt IEC 60730-1-2008

GB14536.10-2008 idt IEC 60730-2-9-2010

3、证书号码 (Certificate No.):

COC: C0C04002009128 (Phenolic)

TUV: 50035898

VDE: 40020934

U L: E251340

4、客户代码: W. HQ

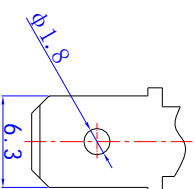
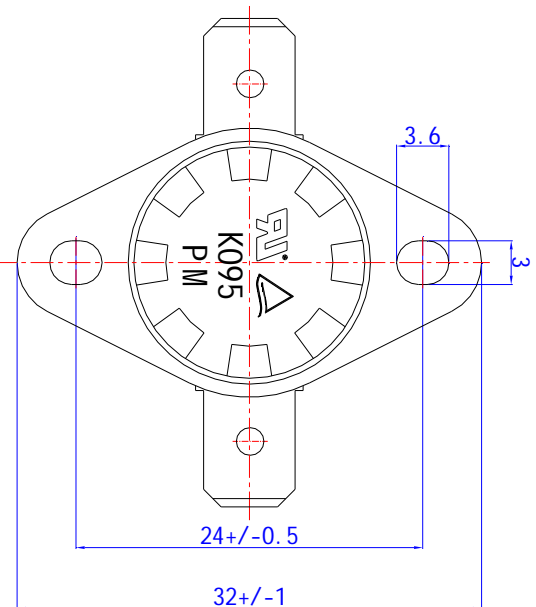
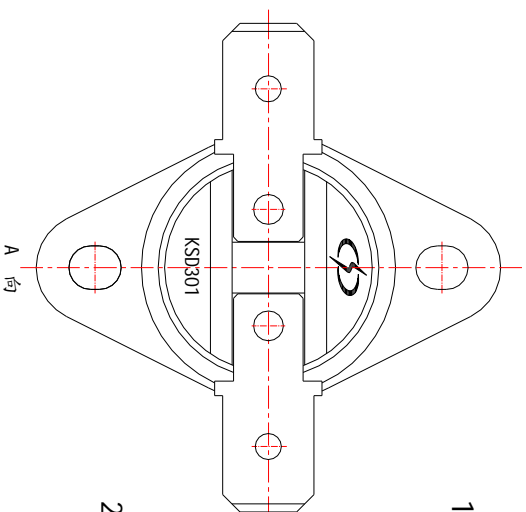
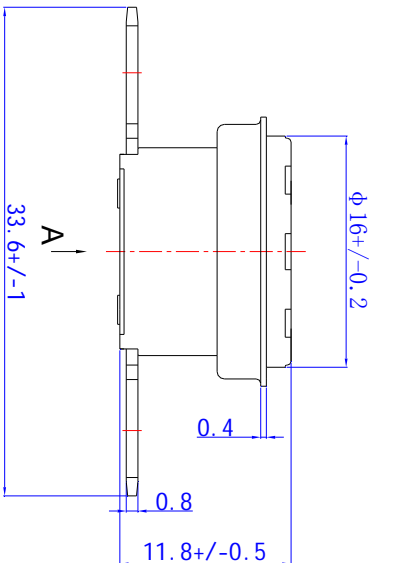

编码/Part. NO	9K3.095/1039AK/181B/RTC-MH0	型号/Model	KSD301	
复位状态/Auto/Manual reset	自动复位	名称/Name	Thermostat/温控器	
动作温度/Open temperature	95+/-3°C	图号/Code	XC-WK.CP/K3.01-XXXX	
复位温度/Close temperature	80+/-5°C	材质/Material	电木	
活动支架/Bracket	小铝盖带活动环	页次/Total	1/1	版本/Edition
端子尺寸/Terminal size	6.3*0.8平脚			A/1
设计/Designed by	刘春青 2018-01-27	 旭程电子(深圳)有限公司温控器事业部 XC ELECTRONICS (SHENZHEN) CO., LTD.		
审核/Checked by				
批准/Approved by				
日期/Date				

承认/
SIGNATURE

核准/
APPROVED BY

客户签章/
CUSTOMER

技术规格

Technology Specification

1. 型号命名 (Type Designation)

KSD.301- XXX / XX X X X X

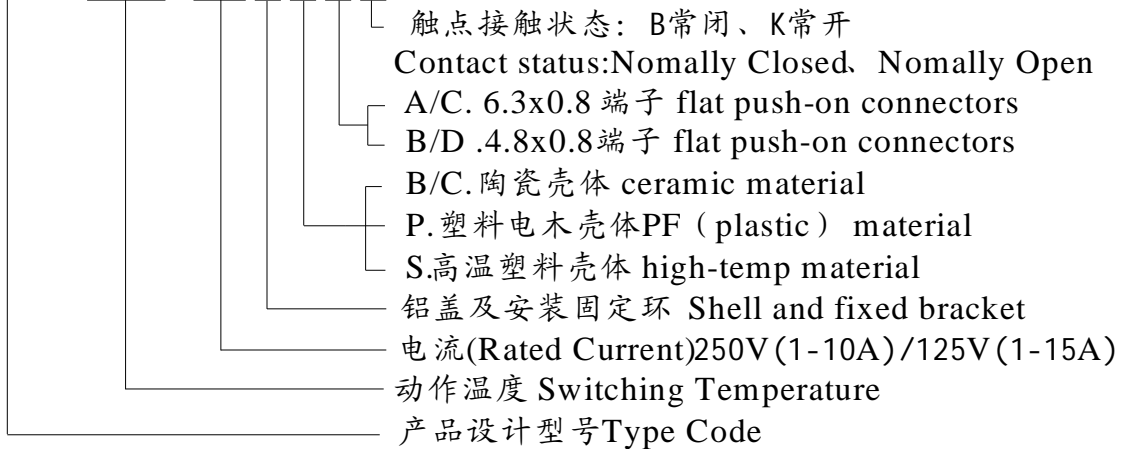

0 ~ 150°C 塑料电木壳体(0 ~ 150°C for KSD301XPZ)

0 ~ 210°C 陶瓷壳体(0 ~ 210°C for KSD301XCZ)

0 ~ 180°C 高温塑料壳体 (0 ~ 180°C forKSD301XSZ)

2. 适用标准(Relevant Standards)

UL873, CSA C22.2 NO 24-93
EN60730-1 2000+A11
EN60730-2-9:2002
GB14536.1-2008 idt IEC730-1
GB14536.10-2008 idt IEC730-2-9-1992

3. 电气性能(Electric Performance):

额定电压(Rated Voltage): AC125V 50~60Hz
额定电流(Rated Current):1-10A/1-15A of Resistive Load
开关类型和单极断开 (Switch Type and Number of poles) : 1 pole opener
IP-防护等级 (Protection Degree) : IP00
动作类型 (Action Type): 2C
认证(Approved Symbol): CQC、T⁺ V、 VDE、 UL
寿命 (Operation Cycles) : CQC、T⁺ V 10,000
VDE、 UL 100,000
所用绝缘材料 PTI 值(Insulation material PTI value):175V
接触电阻 (Resistance of Contact): ≤50mΩ(Original State)
绝缘电阻 (Resistance of Insulated): ≥100MΩ (DC500V Normality)
耐压(Test Voltage): ≥ 1250V/1min(Normality)

4. 端子应能承受的轴向力 (Axis force that tab can endure)

作用于端子的轴向力 1min (如下表) 不应有位移和损坏。

Axis force that Tab can endure for 1min, and no deformation and damage.

推力 thrust force (N)	拉力 pull force (N)	扭力 torque (N.m)
80	70	0.2

5. 标志 (Marking)

在温控器壳体上应标注商标 ，额定电压 250V/125V (必要时) 电流性质交流~，认证标志 (必要时)，型号标志 KSD301，动作温度标示应清晰、持久、耐用，应印在主体及不可拆部体上。

On the thermostat, our trade mark ; voltage rating 250V/125V AC (necessary) ; approved symbol (necessary) .And item No.KSD301 should be carved. Switching temperature should be on the main part of the thermostat or on the part that cannot be torn up. The mark should be clear and durable.

6. 环境试验(Ambient test)

6.1 环境应力(Ambient resistance stress)

温控器在-10℃+/-2℃ 24h,+60℃+/-5℃ 4h,塑料件不应开裂、变形，温控器仍能正常工作。

Under the situation of -10℃+/-2℃ 24h,+60℃+/-5℃ 4h, the plastic parts should be no breaking and deformation, and the thermostat can work normally.

6.2 潮湿试验(Humidity resistance test)

温控器在相对湿度 91~95% 温度在 20~30 (; 1℃) 潮湿箱内处理 48h 应能承受 AC 1250V，频率 50Hz-60Hz 1min 不应产生闪络或击穿。

In the humid box of relative humidity 91-95%, temperature 20~30 (; 1℃) for 48 hours, the thermostat should endure voltage of 1250V AC. When the frequency is 50Hz-60Hz 1min, flashover and bumping is not allowed.

7. 温控器的发热(Heat resistance test)

温控器在比工作温度低 5℃; 1℃ 环境条件下，通 10.6A 电流，它的端子温度不大于 230℃。

The contact temperature of thermostat is not higher than 230℃ in the circuit of 10.6A, at the temperature of less than 5℃; 1℃ of working temperature.

8. 动作方式(Action Forms)

- 室温下触点接通 (nc)，温度上升触点断开，温度降低触恢复接通。
Normal close:Cut out at temperature rise,cut in at temperature decreasing.
- 室温下触点接通 (nc)，温度下降触点断开，温度上升触恢复接通。
Normal close:Cut out at temperature decreasing.,cut in at temperature rise.
- 室温下触点断开 (no)，温度上升触点接通，温度降低触恢复断开。
Normal opon:Cut in at temperature rise, cut out at temperature decreasing.
- 室温下触点断开 (no)，温度下降触点接通，温度上升触恢复断开。
Normal opon:Cut in at temperature decreasing, cut out at temperature rise.
- 室温下触点接通 (nc)，温度上升触点断开，温度降低手动复位接通。
Normal close:Cut out at temperature rise>manual reset at temperature decreasing.

9. 手动复位产品

温控器手动复位产品所受复位力为：14-20N.

Certificate of Compliance

Certificate Number 20041130-E251340
Report Reference 2004 November 30
Issue Date 2005 July 7

Page 1 of 1

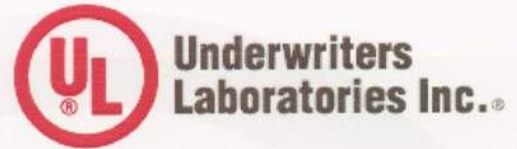

Issued to: **XC ELECTRONICS (SHENZHEN) CORP LTD**

BLDG 11 HEAO HENGGANG, JINYUAN INDUSTRY ZONE
SHENZHEN GUANGDONG 518115 CHINA

This is to certify that representative samples of **Temperature Limiting Thermostat
KSD301**



Have been investigated by Underwriters Laboratories Inc.® in accordance with the Standard(s) indicated on this Certificate.

Standard(s) for Safety: USR/CNR indicates investigation to the U.S. and Canadian (Bi-National) Standard for Temperature-Indicating and -Regulating equipment, CSA C22.2 No. 24-93 Eighth Edition, dated June 1993 * UL 873 Eleventh edition, dated December 22, 1994.

Additional Information:

1. The equipment is enclosed, automatic reset type, SPST, bimetal thermostat, provided with normally closed contacts.
2. The thermostat has been tested for 100,000 cycle of operation at the rated load.
3. The maximum operating temperature of the unit is 150 °C. Calibration test was conducted before and after the endurance test.
4. Electrical rating: 250 V ac, 10 A, 50/60 Hz, Resistive load, Maximum Set point Temperature 150°C.

Only those products bearing the UL Recognized Component Marks for the U.S. and Canada should be considered as being covered by UL's Recognition and Follow-Up Service and meeting the appropriate U.S. and Canadian requirements.

The UL Recognized Component Mark for the U.S. generally consists of the manufacturer's identification and catalog number, model number or other product designation as specified under "Marking" for the particular Recognition as published in the appropriate UL Directory. As a supplementary means of identifying products that have been produced under UL's Component Recognition Program, UL's Recognized Component Mark:  may be used in conjunction with the required Recognized Marks. The Recognized Component Mark is required when specified in the UL Directory preceding the recognitions or under "Markings" for the individual recognitions. The UL Recognized Component Mark for Canada consists of the UL Recognized Mark for Canada:  and the manufacturer's identification and catalog number, model number or other product designation as specified under "Marking" for the particular Recognition as published in the appropriate UL Directory.

Look for the UL Recognized Component Mark on the product

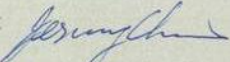
Issued by: 
Jeremy Chen, Acting Section Manager

Underwriters Laboratories Inc.

Any information and documentation provided to you involving UL Mark services are provided on behalf of Underwriters Laboratories Inc., UL International, L.L.C., Taiwan Branch

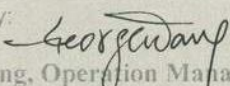
Reviewed by: 
George Wang, Operation Manager

Underwriters Laboratories Inc.

Zertifikat

Certificate



Zertifikat Nr. *Certificate No.*
R 50035898

Blatt *Page*
0006

Ihr Zeichen *Client Reference*

Unser Zeichen *Our Reference*

Ausstellungsdatum

Date of Issue
(day/mo/yr)

05-RBI- 16002148 006

20.07.2015

Genehmigungsinhaber *License Holder*

XC Electronics (Shenzhen)
Corp. Ltd, .
Building 11
Jinyuan Industrial Zone
He'ao Henggang Town
Shenzhen, Guangdong 518115
P.R. China

Fertigungsstätte *Manufacturing Plant*

XC Electronics (Shenzhen)
Corp. Ltd, .
Building 11
Jinyuan Industrial Zone
He'ao Henggang Town
Shenzhen, Guangdong 518115
P.R. China

Prüfzeichen *Test Mark*



Type Approved
Safety
Regular Production
Surveillance

www.tuv.com
ID 2000000000

Geprüft nach *Tested acc. to*

EN 60730-1:2000+A1+A2+A12+A13+A14+A16

EN 60730-2-9:2010

Zertifiziertes Produkt *(Geräteidentifikation)*
Certified Product (Product Identification)

Lizenzentgelte - Einheit
License Fee - Unit

Temperature Control (Thermostat)

as pages 0001-0005

Change

Operating Temperature : 40°C - 180°C for KSD301-xPM

Remark : The labelling requirements acc. to EU Directive 2001/95 have to be observed for distribution within the EEA. The installation has to be carried out according to installation instruction accompanying the products.

ANLAGE (Appendix) : 1.2

Dem Zertifikat liegt unsere Prüf- und Zertifizierungsordnung zugrunde und es bestätigt die Konformität des Produktes mit den oben genannten Standards und Prüfgrundlagen. Zusätzliche Anforderungen in Ländern, in denen das Produkt in Verkehr gebracht werden soll, müssen zusätzlich betrachtet werden. Die Herstellung des zertifizierten Produktes wird überwacht.

This certificate is based on our Testing and Certification Regulation and states the conformity of the product with the standards and testing requirements as indicated above. Any additional requirements in countries where the product is going to be marketed have to be considered additionally. The manufacturing of the certified product is subject to surveillance.

TÜV Rheinland LGA Products GmbH - Tillystraße 2 - 90431 Nürnberg

Tel.: (+49/221)8 06 - 13 71 e-mail: cert-validity@de.tuv.com

Fax: (+49/221)8 06 - 39 35 http://www.tuv.com/safety



G. Yin

X-ON Electronics

Largest Supplier of Electrical and Electronic Components

Click to view similar products for [Thermostats](#) category:

Click to view products by [Xucheng](#) manufacturer:

Other Similar products are found below :

[66F060-0099](#) [66F060-0396](#) [66L085-0477](#) [67F080-0356](#) [67L060-0368](#) [67L080-0038](#) [77877-00](#) [A1014005](#) [ASP200-22](#) [1831436](#) [1F78-151CB](#) [1NT08L-7399](#) [O54EAB240B-215Y](#) [C53GAB101A-081A](#) [22636-00](#) [2450 00210626](#) [2450 00880010](#) [2450CM 80020691](#) [2450RC 79080002](#) [2455R--01000844](#) [2455R 80580176](#) [2455R--90820376](#) [2455R--90820597](#) [2455RA-94170955](#) [2455RC-00980620](#) [2455RCG81170352](#) [2455RM03090005](#) [2455RM 80820736](#) [2455RP-91000430](#) [2455RP-91000433](#) [2455RP-91000436](#) [2455RP-91000442](#) [300004500021](#) [300004520005](#) [300004530001](#) [300005510137](#) [300005510148](#) [300100240216](#) [300100630004](#) [3001 00830006](#) [A1006505](#) [2450 06180001](#) [2450G 83950014](#) [2450RC-90820307](#) [2455R--00030829](#) [2455R--01000140](#) [2455R 01060062](#) [2455R--04170908](#) [2455R 86890009](#) [2455R--99130436](#)