

- NOTES:
- 1:MATERIAL
1-1: SUS-301 THICKNE=0.10MM
 - 2:SPECIFICATIONS
2-1: CONTACT RESISTANCE: 80mΩ/MAX
2-2: RATED CURRENT: 1.0A
2-3: VOLTAGE RATING: 1.5V
2-4: WELDING THRUST: ≥3KG
2-5: OPERATING TEMPERATURE: -40°C~+85°C
 - 3:DURABILITY: 1500 CYCLES
 - 4:SALT SPRAY TIME: 24H
 - 5:ELECTROPLATE: THE NICKEL-PLATED SUBSTRATE IS 50u" MIN
 - 6:REQUIREMENTS
6-1:TERMINAL TO EAT FULL TIN,NOTPEELING, WELDING OBVIOUS COLOR AND OTHED ADVERSE
6-2:ROHS、REACH、HF HALOGER ADVERSE OF DOMESTIC AND INTERNATIONAL ENVIRONMNTAL REQUIREMENTS

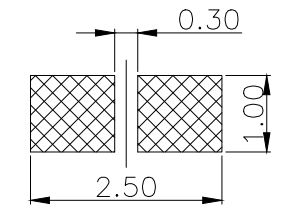

RECOMMENDED PCB LAYOUT
TOLERANCE:±0.05MM
(FOR REFERENCE ONLY)

METAL MASK T=0.08
TOLERANCE:±0.05MM
(FOR REFERENCE ONLY)

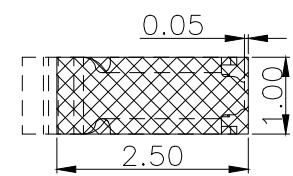
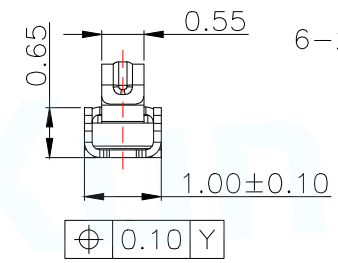
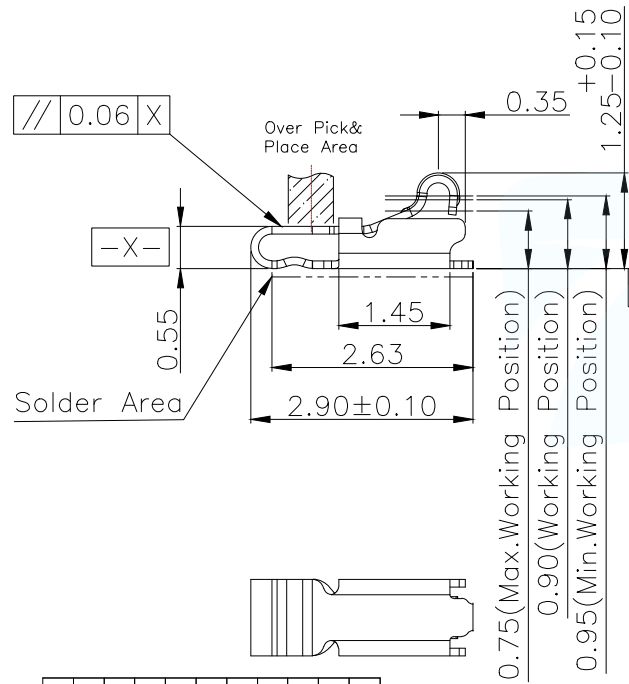
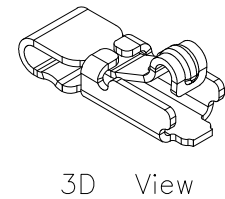
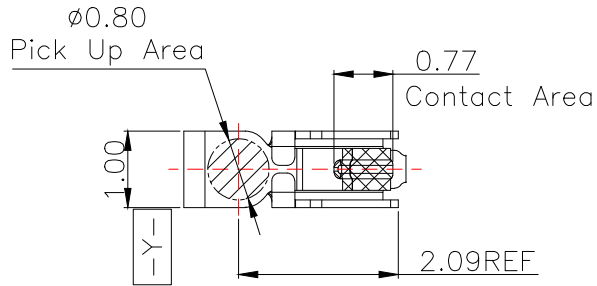
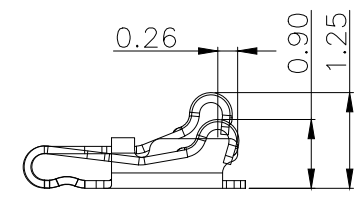
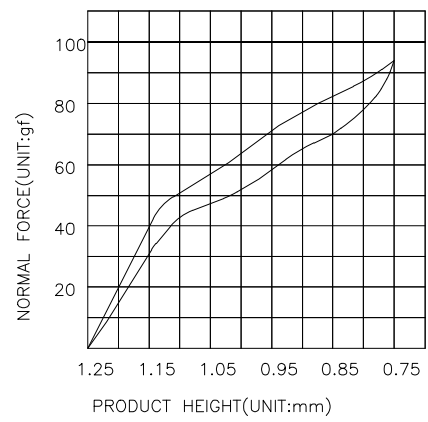

(For Reference Only)
Stated At Compression

MANUFACTURE DWG		东莞市讯普电子科技有限公司 DongGuan XunPu Electronics Co.,Ltd	
UNLESS OTHERWISE SPECIFIED TOLERANCES			TITLE: 天线弹片 L2.90*W1.00*H1.25
			PAR ASP-D1201-B01
DECIMALS:	ANGLES:		DWN
X. ±0.30	X. ° ±0.20		CHKD
.X ±0.20	.X ° ±0.10	APVD	
.XX ±0.15	.XX ° ±0.5	SCALE N:A	UNIT:MM
		SIZE:A4	SHEET:1F1
		CUSTOMER COPY	REV:A

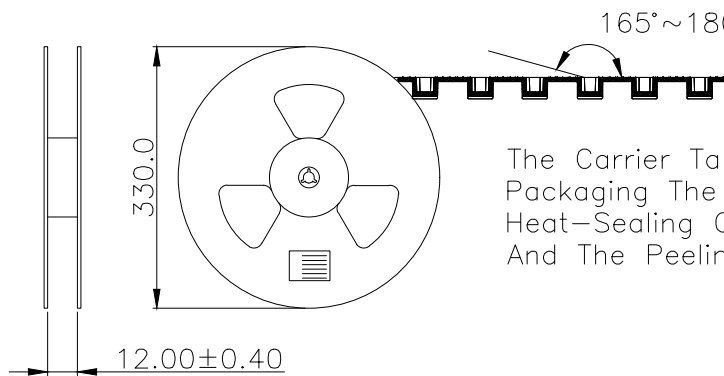
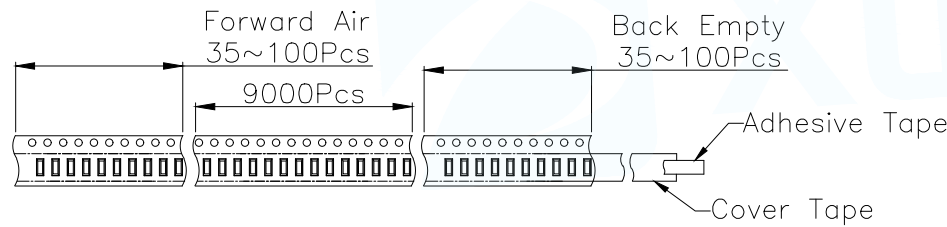
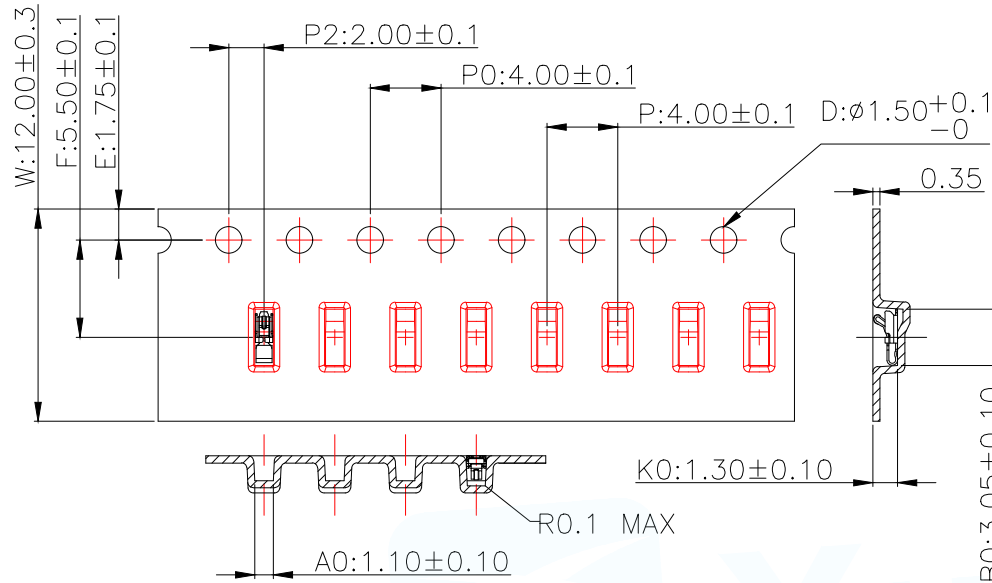

The Carrier Tape Is Heat-Sealed Packaging The Peeling Angle Of The Heat-Sealing Cover Tape Is 165°~180° And The Peeling Force Is 30~120g.

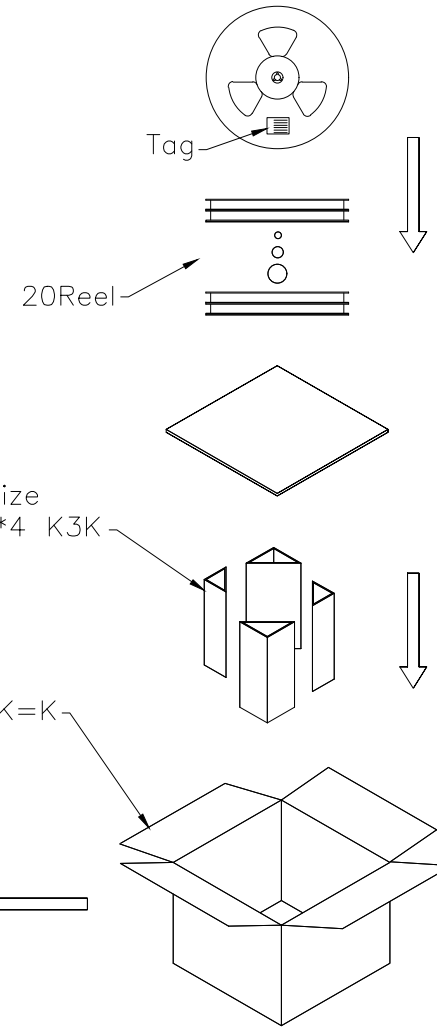

Carton Size 290*330*4 K3K

Carton Size 345*345*360 K=K

MANUFACTURE DWG		东莞市讯普电子科技有限公司 DongGuan XunPu Electronics Co.,Ltd	
UNLESS OTHERWISE SPECIFIED TOLERANCES			TITLE: 天线弹片 L2.90*W1.00*H1.25
DECIMALS:	ANGLES:		PAR ASP-D1201-B01
X. ±0.30	X. ° ±0.20		DWN
.X ±0.20	.X ° ±0.10		CHKD
.XX ±0.15	.XX ° ±0.5	APVD	SCALE N:A UNIT:MM
CUSTOMER COPY		SIZE:A4	SHEET:1F1 REV:A

X-ON Electronics

Largest Supplier of Electrical and Electronic Components

Click to view similar products for [Circuit Board Hardware - PCB category](#):

Click to view products by [XUNPU manufacturer](#):

Other Similar products are found below :

[8919-0-00-15-00-00-03-0](#) [5970-1-15-01-32-14-04-0](#) [MKU 1 BLACK](#) [MLN 150/1 BLACK](#) [8579-1-15-15-11-27-10-0](#) [PRUEF 1 RED](#) [PRUEF 2 RED](#) [PW1616](#) [MPS 1 BLACK](#) [1548-103](#) [2317-2-00-50-00-00-07-0](#) [2506-2-00-50-00-00-07-0](#) [SCREWCLAMP EASY2](#) [SCREWCLAMPEASY750GEO](#) [9873-0-15-80-02-80-10-0](#) [2104-2-01-80-00-00-07-0](#) [PG-9](#) [2308-4-00-44-00-00-07-0](#) [2314-2-01-50-00-00-07-0](#) [2352-3-01-50-00-00-07-0](#) [2506-3-00-50-00-00-07-0](#) [251-103](#) [3330-1-00-15-00-00-03-0](#) [430-107](#) [TO-100-030](#) [TO-16-030E](#) [TO-203-040E](#) [TO-24-100](#) [TO-64-030](#) [5062-0-00-21-00-00-33-0](#) [5108](#) [325-102](#) [WLPL-141](#) [Z4.102.1680.0](#) [5119](#) [0153-4-15-80-30-27-04-0](#) [0252-0-15-01-32-27-10-0](#) [0253-0-15-15-30-27-10-0](#) [0255-0-15-01-30-27-04-0](#) [0290-0-00-15-00-00-03-0](#) [0309-2-15-80-47-27-10-0](#) [02-41](#) [0405-0-15-80-34-27-04-0](#) [0569-0-15-15-11-27-10-0](#) [0579-0-15-01-11-27-10-0](#) [0489-0-15-01-11-27-04-0](#) [0489-2-15-15-11-27-04-0](#) [0553-1-15-01-11-27-10-0](#) [0554-0-15-15-11-27-10-0](#) [0579-0-15-15-21-14-10-0](#)