

- NOTES:
- 1:MATERIAL
1-1: SUS-304 THICKNE=0.10MM
 - 2:SPECIFICATIONS
2-1: RATED CURRENT: 1.0A
2-2: VOLTAGE RATING: 1.5V
2-3: CONTACT RESISTANCE: 80mΩ/MAX
2-4: WELDING THRUST: ≥3KG
2-5: OPERATING TEMPERATURE: -40°C~+85°C
 - 3:DURABILITY: 1500 CYCLES
 - 4:SALT SPRAY TIME: 24H
 - 5:ELECTROPLATE: THE NICKEL-PLATED SUBSTRATE IS 50u" MIN
 - 6:REQUIREMENTS
6-1:TERMINAL TO EAT FULL TIN,NOTPEELING, WELDING OBVIOUS COLOR AND OTHER ADVERSE
6-2:ROHS.REACH.HF HALOGER ADVERSE OF DOMESTIC AND INTERNATIONAL ENVIRONMNTAL REQUIREMENTS

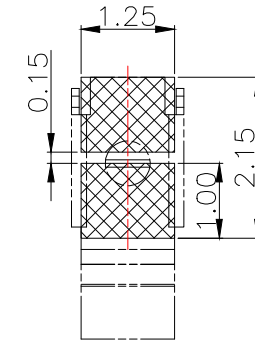

RECOMMENDED PCB LAYOUT
TOLERANCE:±0.05MM (FOR REFERENCE ONLY)

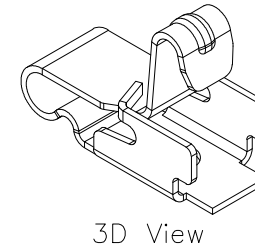
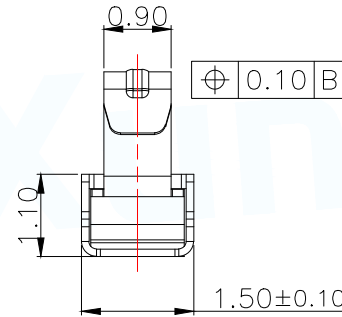
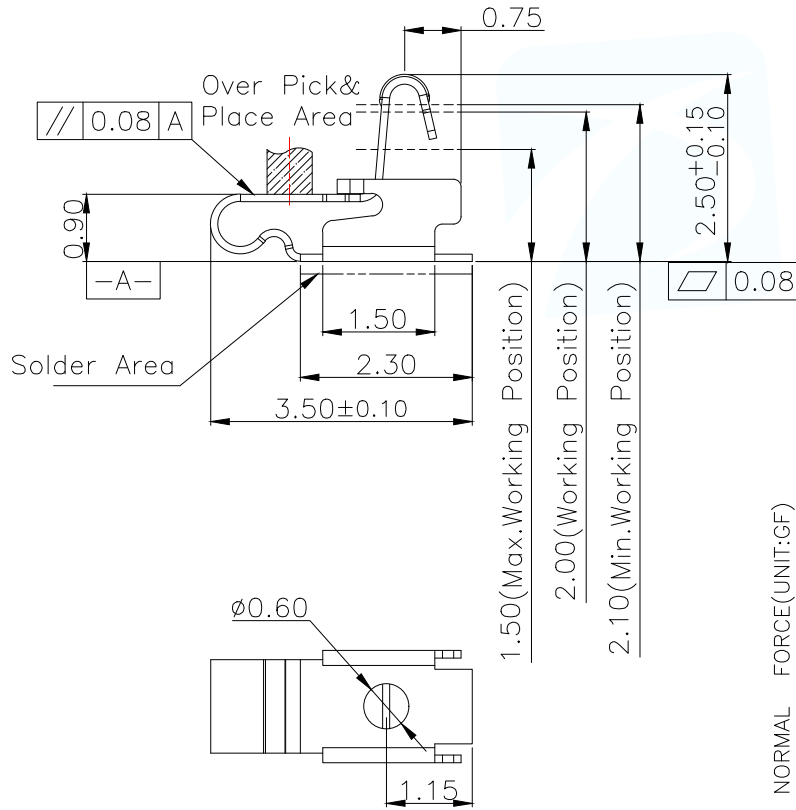
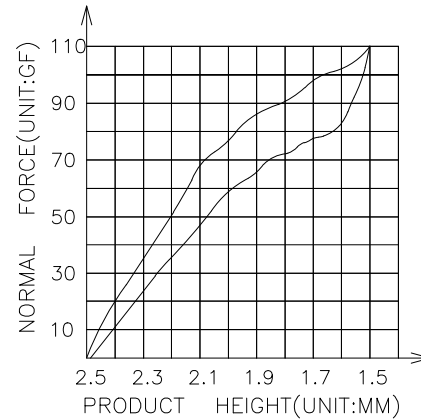

MANUFACTURE DWG		东莞市讯普电子科技有限公司 DongGuan XunPu Electronics Co.,Ltd	
UNLESS OTHERWISE SPECIFIED TOLERANCES			TITLE: 天线弹片 L3.50*W1.50*H2.50
DECIMALS: X.:±0.30			PAR ASP-D2506-A01
ANGLES: X':±2'			DWN Lucas
X.X:±0.20			CHKD Ethan
X.XX:±0.15		X.X':±1'	APVD Jacob
X.XX':±0.5'		CUSTOMER COPY	SCALE:1:1 UNIT:MM
		SIZE:A4	SHEET:1F1
			REV:A

12	13	14	15
MAPX	MODIFICATION	DATE	DRAW

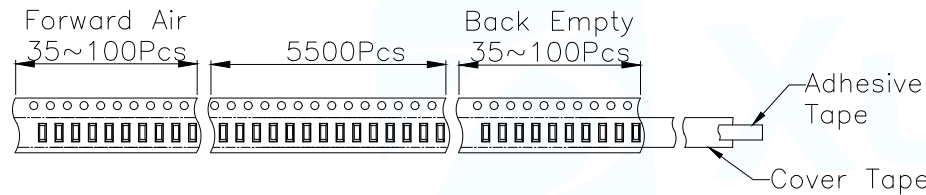
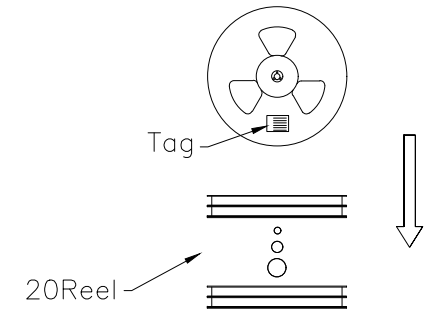
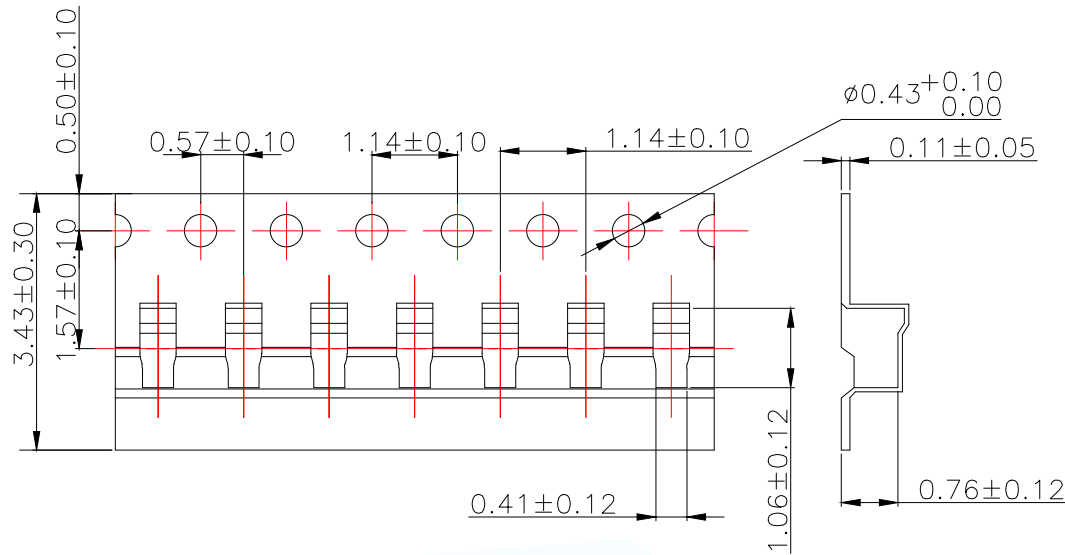

Carton Size
290*330*4 K3K

Carton Size
345*345*360 K=K

Customer To Use Direction

Pull Out Direction
(出料方向)

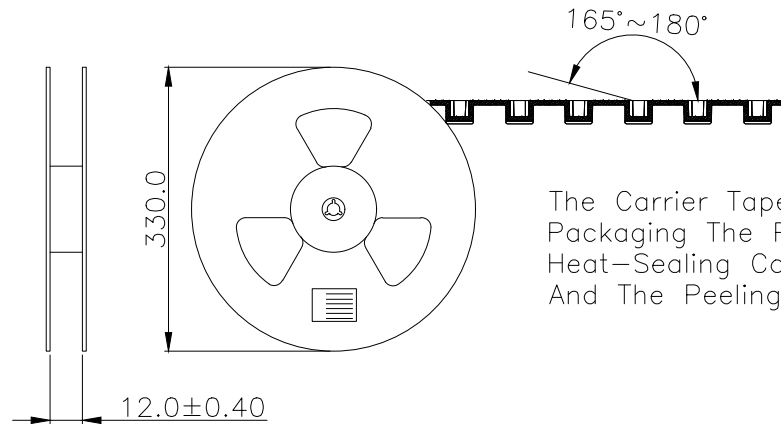

The Carrier Tape Is Heat-Sealed Packaging The Peeling Angle Of The Heat-Sealing Cover Tape Is $165^\circ \sim 180^\circ$ And The Peeling Force Is 30~120g.

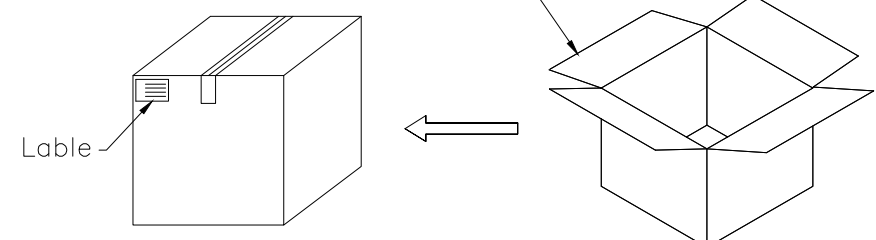

MANUFACTURE DWG		东莞市讯普电子科技有限公司 DongGuan XunPu Electronics Co.,Ltd	
UNLESS OTHERWISE SPECIFIED TOLERANCES			TITLE: 天线弹片 L3.50*W1.50*H2.50
			PAR ASP-D2506-A01
DECIMALS:	ANGLES:		DWN Lucas
X.:±0.30	X':±2'		CHKD Ethan
X.X:±0.20	X.X':±1'	APVD Jacob	SCALE:1:1 UNIT:MM
X.XX:±0.15	X.XX':±0.5'	CUSTOMER COPY	SIZE:A4 SHEET:1F1 REV:A

X-ON Electronics

Largest Supplier of Electrical and Electronic Components

Click to view similar products for XUNPU manufacturer:

Other Similar products are found below :

[TYC-302-08](#) [TS-1003-06526](#) [TS-1003-08026](#) [TS-1003-09526](#) [TS-1009S-05526](#) [TS-1003S-06526](#) [TS-1003S-07526](#) [TS-1003T-26](#) [TS-1002-BR12516](#) [TS-1009S-AR03816](#) [TS-1003S-BR07016](#) [WAFER-MX1.25-10PLB](#) [FPC-0.5AL-12PB](#) [TYPEC-249D-BRP6](#) [WAFER-MX1.25-4PWZ](#) [TS-1002S-BR15526](#) [TS-1056SG-AR04326](#) [FFC-1.0-10-100-A-4-8](#) [SMA-JWE-324-H13X15-LW](#) [WAFER-XH2.54-6PLB](#) [SD-101](#) [SD-107](#) [TS-1002N-10026](#) [TS-1003S-06026](#) [TS-1010GD-BR09026](#) [TS-1010GS-BR05026](#) [TS-1080S-AC01516](#) [TS-1002N-BR05016](#) [TS-1002N-BR08016](#) [SIM-105-ARP6](#) [FH2.54-09-07PZD](#) [WAFER-PH2.0-7PWZ](#) [WAFER-WTB4.2-14PWZ](#) [SMA-KWE-323C-H13X23-LW](#) [TS-1002-BR15026](#) [WAFER-PH2.0-10PZZ](#) [TYPEC-254-BRP6H65](#) [TYC-340-16CB16](#) [TS-1003S-11026](#) [TS-1009-06026](#) [USB-234-ACY](#) [TS-1010DGS-BR06026](#) [TS-1002-BR05016](#) [TS-1002NT-BR07316](#) [TF-123-ARP9H15](#) [WAFER-MX1.25-8PWB](#) [WAFER-PH2.0-5PLB](#) [TF-121-ARP8H30](#) [TS-1003-09026](#) [TS-1009B-04326](#)